

**PRODUCT
CATALOGUE
2023**







CLA LIGHTING

Operating as a 100% Australian owned company, we are proud to have come a long way since we began in 1999, on the Northern Beaches of Sydney. Since its inception, CLA has continuously evolved to keep abreast of the latest in national and international lighting trends to provide benchmark technology in our diverse range of lighting products. These include indoor and outdoor decorative lighting, high-quality energy saving lamps, trendy lighting fixtures and related products for all commercial, industrial, residential and utility markets.

All our products are manufactured to comply with all Australian and New Zealand standards and we are a proud member of the Australian Lighting Council. With warehouses strategically located across Australia & New Zealand, we ensure prompt dispatch and delivery. We use our strength as a lighting leader to provide you with superior customer service, innovative lighting solutions, quality and performance.

This New 2023 catalogue makes us proud to show case the depth in niche product range CLA has to offer.

CONTENTS



SMART LIGHTING 016

DECOR LIGHTING 022

Interior Pendant Lights	022
Ceiling Spot Lights	158
Table & Floor Lamps	161
Interior Wall Lights	171
D.I.Y. Decor	191

EXTERIOR LIGHTING 200

Exterior Pendant Lights	202
Exterior Wall / Floor Lights	201
Exterior Bulkhead Lights	234
Exterior Ceiling / Oyster Lights	240
Exterior Step Lights	243
Exterior Pillar Lights	249
Exterior Bollard & spike Lights	275
Exterior Pond Spot Lights	293
Exterior Deck & Inground Up Lights	294
Flood Lights & Exterior Battens	299

GENERAL LIGHTING 303

Downlights	303
Spot Lights	320
Oyster Lights	325
Battens	330
Connectable Track Systems	334
Interior utility Lights	356
High Bays	361
Security Lights	363

GLOBES 366

LED Globes	366
Fluorescent Globes	406
Carbon Filament Globes	410
Heat Lamp Globes	414
Metal Halide Globes	416

ACCESSORIES 419

Decor Lighting Accessories	419
Control Gear	421
Electrical Accessories	426

TEAM BRAND PRODUCTS 444

Automobile Accessories	444
Automobile Globes	449
Automobile Care Products	452
Head Lamps, Torches & Work Lights	455

Smart Lighting



SMTNOVA P17



SMTOYS P18



SMTFLOOD P19



SMTGU10 P20



SMTGLS P21

Decor - Interior Pendant Lights



VINTAJ1-6 P23



VINTAJ7-12 P24



VINTAJ13-18 P25



BARRIQUE P26



VOTIF P28



BANQUET P29



PELOTA P30



MARACA P32



MARBRE P33



DIABLO P34



MANU P35



BROTE P36



MIKRO P37



GOLPE P38



SARI P40



CANAMO P41



COUP P42



ROTA P43



CESTA P44



CANASTA P45



CEREMA P46



PLIER P47



ORIGAMI P48



TUILE P50



BOTANICA P52



MARRAKESH P53



PATERA P54



PESINI P55



VINUM P56



ROCHE P57



JEREZ P58



CHAMPAN P60



TRATTINO P62



TULIP P64



CIOTOLA P66



ESPEJO P68



FOSSETTE P72



MARTE P73



VAINA P74



BELLA P75



ESCAMA P76



CLEO P77



PASTILLE P78



PAPILLON P79



CHAPEAU P80



CONTOUR P81



IDA P82



GOLDA P83



CORAZON P84



METEORA P85



ABBEY P86



HEXADE P88



HEXA P89



STRATO P90



ORBITA1-2 P92



ORBITA3-5 P93



SPUTNIK P94



MAZZA P95



HOPI P96



METI P97



BONITO P98



KHALESSI P100



SEÑORITA P101



PENDOLO P102



AUTUMN P103



NORDIC P104



TAMBURA P106



SWING P107



HORTEN P108



FINN P109



LANTERNA P110



FARO P111



LIGNA P113



ZARA P114



ARMIS P117



LEGNA P118



CELESTE P119



KOPER P120



MODELLO P121



GLAZE1-5 P122



GLAZE10-11 P123



RICTUS P124



ORDITO P125



MASON P126



CHUVA P127



BARROSA P129



PENOLA P129



RIVERINA P129



YARRA P129



CASA P130



FUMOSO P131



LAMINA P132



TONO P133



GAMBA P135



SPIAGGIA P136



STRAND P137



VENETO P138



CHEVEUX P139



SENTINEL P140



MATRIX P141



BLACKBAND P142



WHITEBAND P143



PASTEL01-07 P145



PASTEL08-14 P147



ALTA P148



NARVIK P149



DIVO P150



DEKSEL P152



CAVIAR P153



CLASSIC P154



PIATTO P155



PEN P156



CLUSTER P157

Decor - Ceiling Spot Lights



TACHE1-3 P159

TACHE4-6 P160

Decor - Table / Floor Lamps



TAMBURA TL P162



TAMBURA FL P163



LOTUS P164



FOKUS P165



PASTEL TL P166



PASTEL FL P167



VENETO P168



PUNK P169



AUTUMN P169



MOOD P170

Decor - Interior Wall Lights



PESINI P172



VINUM P173



STRUNG P174



ALTA P175



STEAM P176



VENETO P177



DEKSEL P178



AUTUMN P178



METI P179



SPUTNIK P179



ATHENSG2 P180



BARCELONA P180



CANNES P181



DAVOS P181



DELHI P181

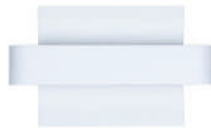

DUBAI P182



GENEVA P182



LONDON P182



MILAN P183



NEW YORKG2 P183



PARIS P183



PHOENIX P184



RIOG2 P184



ROMEG2 P184



SYDNEYG2 P185



VENICEG2 P185



VIENNA P185



SEATTLE P186



DUBAIG2 P187



VIGO P187



BRIGHTON P188



CHESTER P189



VANITY P190

Decor - D.I.Y. Decor



DIYBAT01-04 P192



DIYBAT05-08 P193



DIYBAT09-12 P194



DIYBAT13-16 P195



DIYBAT17-20 P196



DIYBATC P197



SHADE01-04 P198



SHADE05-08 P199

Exterior Lighting



RUBIK P201



SPY P202



TREC P203



DEKSEL P204



SKOPA P205



MAGNUM P206



HINK P207



TORQUE1-2 P208



TORQUE3-4 P209



MIDO P210



SOMBRA P211



BOCINA P212

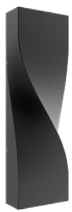

GIRO P213



PLA P214



REPISA P214



PLANA P215



GLANS P216



AKEN P217



APIS P218



ATEN P219



MARINA P220



KUK P221



HEKA P222



TOPA P223



TAMA P224



REMO P224



BES P225



WIG P226



VOX P227

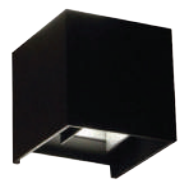

TOCA1-2 P228



TOCA3-4 P229



WEDGEG P230



NED P231



BRICK P232



OGA P233



BULK1-2 P234



BULK3 P235



BULK5 P235



BULK7 P235



BULK9-10 P236



BULK11-14 P237



BULK15-18 P238



CLA4736 P239



ULAN P240



DOCCIA P241



OYSDIM P242



STE1-4 P243



STE5-6 P244



STE7-8 P244



STE9-10 P245



STE12&23 P246



STE13-14 P247



STE15-18 P247



STE19-22 P248



PDL PILLAR P249



SPOT PILLAR P251



PILLAR LIGHTS P252



ELANORA P275



BORDA P276



TORRE P277



PHARE P278



PORTUS P280



SHU P281



GEB P282



AMUN P283



HATHOR P284



SETH P285



HORUS P286



SEKER P287



BOL P288



SPM P289



SPMS P290



COOLIE P291



KOLEC P292



KAM P292



PHARE P293



POND SPOT P293



DECK P294



INGROUP UP P295

SMART LIGHTS



SMTFLOOD P299



TABLET P300



FLOOD15-16 P300

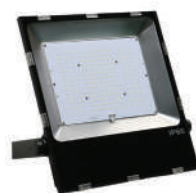

FLOOD14&22 P301

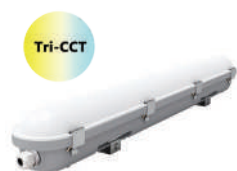

Tri-CCT

SHIELDTRI P302

General - Downlights

SMART LIGHTS



SMTNOVA P304



Tri-CCT

NOVACOB P305



Tri-CCT

NOVADLUX P306



Tri-CCT

FIREFLY P308



Tri-CCT

COMET01-04 P309



Tri-CCT

COMET05-08 P310



Tri-CCT

GALTRI P311



Tri-CCT

COSMOTRI P312



Tri-CCT

NOVATRI P313



MOTION P314



Tri-CCT

SLICKTRI P315



Tri-CCT

SHOPTRI01 P316



Tri-CCT

SHOPTRI P317



SURFACE P318

General - Spot Lights



SPOT BLACK P321



SPOT WHITE P322



TACHE1-3 P323



TACHE4-6 P324

General - Oyster Lights

SMART LIGHTS



SMTOYS P326



OYSDIM P327

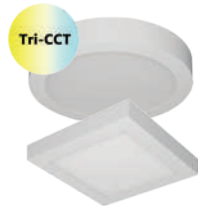

SURFACETRI P329

General - Battens



RAZORDM P331



RAZORDMW P332



SHIELDTRI P333

General - Connectable Track Systems



GU10 TRACK HEADS
P335



TRKTRI P336



ZONE P337



ACCESSORIES P343

General - Interior Utility Lights



RAZORDM P357



RAZORDMW P358



LINKTRI P359



NIGHT P360

General - High Bays & Security Lights



HIB P362



SEC01-02 P364



SEC03-04 P365

Globes - LED Globes

SMART LIGHTS



SMTGU10 P367



GU10TRI P368



GU10 P368



GU10 DIMM P369



GU10 RGB P369



MR16TRI P370



MR16 P370



MR16 RGB P371



MR11 P372

SMART LIGHTS



SMTGLS P373



GLSTRI P374



GLS FILAMENT P374



GLS FILAMENT P375



GLS P376



FR FILAMENT P378



FR FILAMENT P378



FR P379



CANDLE FILAMENT P381



CANLE FILAMENT P381



CANDLE P383



T40 P386



G95 FILAMENT P387



G95 FILAMENT P388



G95 P388



G125 FILAMENT P389



G125 FILAMENT P390



G125 FILAMENT P390



G125 P391



PEAR FILAMENT P392



ST57 FILAMENT P392



SUB PAR38 P393



PAR30 P393



R63 & R80 P394



PILOT P394



T30 FILAMENT P395



R7 P395



R7S P396



SPECTRA P397



CHAMA P398



BUG P398



3U P399



GX53 P399



G4 BI-PIN P400



G4 BI-PIN P400



G9 P401



PLC P402



ELLIP P403



PT8 P404



CKTRI P405

Globes - Fluorescent Globes



2D FL P407



T5 FL P407



T9 FL P408



T5 TUBE P408



PL DU FL P409



PL DUE FL P409

Globes - Carbon Filament Globes



G95 P411



G125 P411



ST57 P412



T45 P412



T9 P413

Globes - Heat Lamp Globes



CLAH P415

Globes - Metal Halide Globes



CLAMHS P417



CLAMHD P417



CLAMCD P418



CLAMCP P418

Accessories



CLUSTER P420



DRIVER IP67 P422



DRIVER IP20 P424



TRANSFORMER P425



DIMMER P427



SENSOR P429



CONNECTOR P436



SADDLE P438



SOCKET P439



BATTEN FIXTURE P440



FLEX & PLUG P441



LAMP HOLDER P441



PLUG P442



LEAD P442



POWER BOARD P443

Team Brand Products



TYRE PUMP P445



JUMP START P445



DRIVER IP20 P448



AUTO GLOBES P449



DETAILERS JELLY P452



RAG P452



SYNTHETIC CHAMOIS CLOTH P453



DRYING TOWEL P453



HEAD LIGHT RESTORATION KIT P454



WINDOW REPAIR KIT P454



HEAD LIGHTS P455



TORCH & WORK LIGHTS P456

ATTENTION:

The pendant lights are hand made items, so the colour and shape of each piece may vary slightly. Please check that you are happy with the quality and finish of these products BEFORE INSTALLATION. CLA LIGHTING offer a replacement warranty only. Installation costs will not be borne by CLA Lighting.

All products comply with "all Australian and NZ Standards"

All images and information in this publication are current at the time of print and are to be used as a guide only. Please refer to our website www.clalighting.com.au prior to purchase for updates since the print of this publication or email us at sales@clalighting.com.au or call our Sydney office on (02) 9938 7100



SMART LIGHTING
LED SMART LIGHTS

- LED SMART dimmable Tri-CCT + RGB downlight
- Input voltage range: 220-240V 50Hz
- Inbuilt constant current LED driver included
- Housing: plastic & aluminium
- Faceplate: PC
- Heatsink: aluminium
- Frosted Diffuser
- LED chips: SMD2835
- CRI: ≥80
- Power factor: ≥0.5
- Ambient temperature: -20 to 40°C
- Flex & Plug: 1m
- **App: control all functions via Tuya app on smart devices**
- **Manual: on/off control via normal wall switch**
- **Dimmable only via app or voice control through Amazon Alexa, Google Home and other compatible voice activated control devices (Not compatible with wall switch dimmer)**
- Setup requires WiFi with Internet connection
- Suitable for 2-way switching
- Not suitable for use with sensor



SMTNOVA1

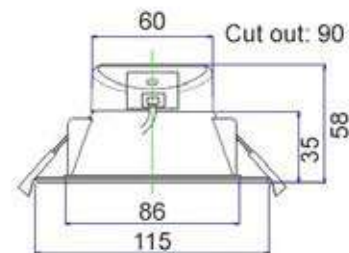
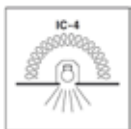
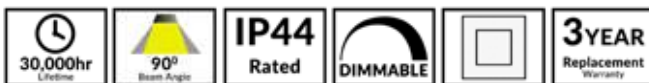

Additional SMART Features:

- Tuneable RGB colour spectrum (up to 14 million colours)
- Tuneable colour temperature (3000K warm white through to 6500K daylight)
- Works with any 2.4GHz enabled WiFi network (note: will not currently pair with 5.0GHz bandwidth or Bluetooth LE 4.2)
- Create schedules and timing to automate your home
- Control from anywhere via app or voice control using Alexa Hubs, Google Home and other compatible devices
- Compatible with all Tuya Powered apps



Scan QRCode to download

Part No.	Description	Kelvin	Lumens	Watt	Product Dimensions	Cut Out	Carton QTY
SMTNOVA1	D/L LED SMART WH RND DIMM TRI+RGB	RGB+ 3000- 6500K	750LM - 3000K 820LM - 6500K 60LM - Red 45LM - Blue 190LM - Green	9W	Ø115x58mm	Ø90mm	1/48



- LED smart Tri-CCT dimmable oyster light
- Input voltage range: 220-240V 50Hz
- Inbuilt constant current LED driver included
- Housing: powder coated iron
- Mounting plate: iron
- Heatsink: iron & aluminium
- Diffuser: PMMA
- LED chips: SMD2835
- CRI: ≥80
- Power factor: ≥0.9
- Ambient temperature: -20 to 40°C
- App: control all functions via Tuya app on smart devices
- Manual: on/off control via normal wall switch
- Dimmable only via app or voice control through Amazon Alexa, Google Home and other compatible voice activated control devices (Not compatible with wall switch dimmer)
- Setup requires WiFi with Internet connection
- Suitable for 2-way switching
- Not suitable for use with sensor

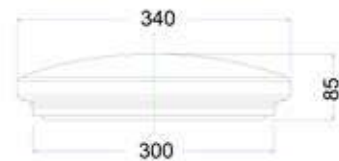
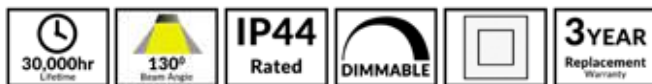

Additional SMART Features:

- Tuneable colour temperature (3000K warm white through to 6500K daylight)
- Works with any 2.4GHz enabled WiFi network (note: will not currently pair with 5.0GHz bandwidth.) or Bluetooth LE 4.2
- Create schedules and timing to automate your home
- Control from anywhere via app or voice control using Alexa Hubs, Google Home and other compatible devices
- Compatible with all Tuya Powered apps

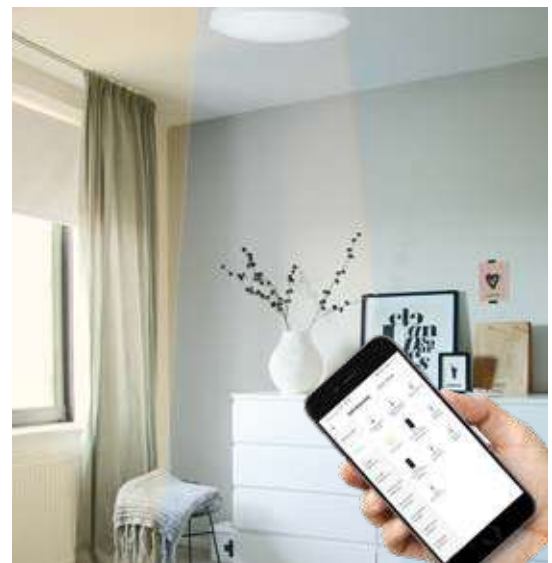
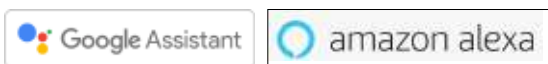

Part No.	Description	Kelvin	Lumens	Watt	Dimensions	Base	Carton QTY
SMTOYS1	OYSTER LED SMART WH RND DIMM TRI CCT	3000-6500K	1350-1550LM	18W	Ø340x85mm	Ø300mm	1/8

SMTFLOOD Flood Lights

SMART LIGHTS

- Input voltage range: 220-240V 50/60Hz
- Inbuilt constant current LED driver included
- Housing: powder coated aluminium
- Heatsink: aluminium
- Diffuser: glass
- LED chips: SMD2835
- CRI: ≥ 80
- Power factor: ≥ 0.9
- Ambient temperature: -20 to 40°C
- Flex & Plug: 1.2m
- App: control all functions via Tuya app on smart devices
- Manual: on/off control via normal wall switch
- Dimmable only via app or voice control through Amazon Alexa, Google Home and other compatible voice activated control devices (Not compatible with wall switch dimmer)
- Setup requires WiFi with Internet connection
- Suitable for 2-way switching
- Not suitable for use with sensor

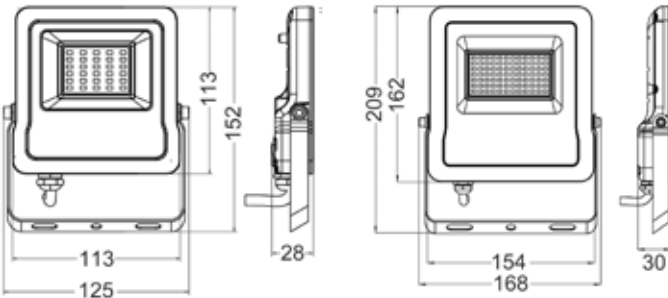

SMTFLOOD1

SMTFLOOD2



Additional SMART Features:

- Tuneable RGB colour spectrum (up to 14 million colours)
- Colour temperature: 5000K
- Works with any 2.4GHz enabled WiFi network (note: will not currently pair with 5.0GHz bandwidth.) or Bluetooth LE 4.2
- Create schedules plans, Biorhythm and timing to automate your home
- Ability to set power-on behaviour
- Control from anywhere via app or voice control using Alexa Hubs, Google Home and other compatible devices
- Compatible with all Tuya Powered apps



Part No.	Description	Kelvin	Lumens	Watt	Product Dimensions	Carton QTY
SMTFLOOD1	FLOOD LED SMART Blk Dimm 5K+RGB 10W	5000K	800LM	10W	152x125x28mm	1/20
SMTFLOOD2	FLOOD LED SMART Blk Dimm 5K+RGB 30W	5000K	2400LM	30W	209x168x30mm	1/20

SMTGU10 (5W) LED Globes

SMART LIGHTS

- GU10 LED smart Globe
- Input voltage range: 220-240V 50/60Hz
- Shade & diffuser: plastic
- LED chips: 20pcs SMD2835
- CRI: ≥80
- Power factor: 0.5
- Ambient temperature: -20 to 30°C
- App: control all functions via Tuya app on smart devices
- Manual: on/off control via normal wall switch
- Dimmable only via app or voice control through Amazon Alexa, Google Home and other compatible voice activated control devices (Not compatible with wall switch dimmer)
- Setup requires WiFi with Internet connection
- Suitable for 2-way switching
- Not suitable for use with sensors



Additional SMART Features:

- Tuneable RGB colour spectrum (up to 14 million colours)
- Tuneable colour temperature (3000K warm white through to 6500K daylight)
- Works with any 2.4GHz enabled WiFi network (note: will not currently pair with 5.0GHz bandwidth.) or Bluetooth LE 4.2
- Create schedules and timing to automate your home
- Control from anywhere via app or voice control using Alexa Hubs, Google Home and other compatible devices
- Compatible with all Tuya Powered apps

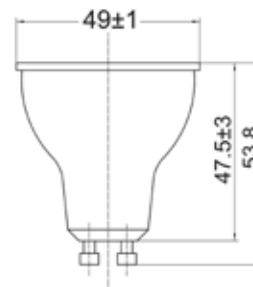

Scan QRCode to download

Part No.	Description	Base	Kelvin	Lumens	Watt	Dimensions	Carton QTY
SMTGU101	GLOBE LED SMART GU10 5W RGB TRI CCT	GU10	RGB+ 3000- 6000K	360-450LM- 3000K 400-500LM- 4000K 400-500LM-6000K	5W	Ø50X53.8mm	1/10/100

- GLS LED smart Globe
- Input voltage range: 220-240V 50/60Hz
- Housing: plastic & aluminium
- Diffuser: plastic
- Frosted Diffuser
- LED chips: 20pcs SMD2835
- CRI: ≥ 80
- Power factor: ≥ 0.5
- Ambient temperature: -20 to 30°C
- App: control all functions via Tuya app on smart devices
- Manual: on/off control via normal wall switch
- Dimmable only via app or voice control through Amazon Alexa, Google Home and other compatible voice activated control devices (Not compatible with wall switch dimmer)
- Setup requires WiFi connection
- Suitable for 2-way switching
- Not suitable for use with sensor



Additional SMART Features:

- Tuneable RGB colour spectrum (up to 14 million colours)
- Tuneable colour temperature (3000K warm white through to 6500K daylight)
- Works with any 2.4GHz enabled WiFi network (note: will not currently pair with 5.0GHz bandwidth.) or Bluetooth LE 4.2
- Create schedules and timing to automate your home
- Control from anywhere via app or voice control using Alexa Hubs, Google Home and other compatible devices
- Compatible with all Tuya Powered apps

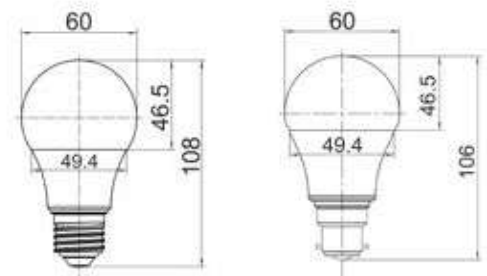
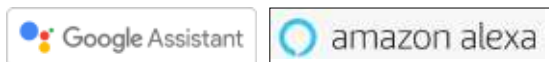

 Tuya Smart
Formal version



Scan QRCode to download

Part No.	Description	Base	Kelvin	Lumens	Watt	Dimensions	Carton QTY
SMTGLS1	GLOBE LED SMART ES GLS 10W RGB TRI CCT	E27	RGB+ 3000- 6000K	700-800LM- 3000K 750-880LM- 4000K	10W	Ø60X108mm	1/10/100
SMTGLS2	GLOBE LED SMART BC GLS 10W RGB TRI CCT	B22	6000K	750-880LM-6000K	10W	Ø60X108mm	1/10/100



**DECORATIVE
INTERIOR PENDANT LIGHTS**

VINTAJ Interior Pendant Lights



VINTAJ1
(Smokey Black Glass)



VINTAJ2
(Green Glass)



VINTAJ3
(Amber Glass)



VINTAJ4
(Copper Painted Glass)



VINTAJ5
(Chrome Glass)



VINTAJ6
(Clear Glass)

- Interior wine glass ribbed glass pendant lights
- Material: glass
- Globe not included
- For indoor use only



Part No.	VINTAJ1-6
Description	PENDANT ES Wine Glass Ribbed Glass w/Brass + RND BLK Canopy
Material	Glass
Lamp holder	1xE27 (Max.72W)
Dimensions	Ø200 x H305mm
Suspension	3000mm black cable
Canopy size	Ø100 x 25mm
Carton QTY	1/1

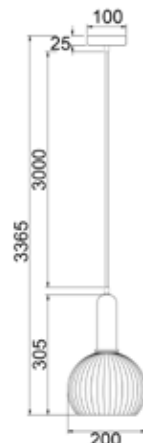



VINTAJ7
(Smokey Black Glass)



VINTAJ8
(Green Glass)



VINTAJ9
(Amber Glass)



VINTAJ10
(Copper Painted Glass)



VINTAJ11
(Chrome Glass)



VINTAJ12
(Clear Glass)

- Interior ellipse ribbed glass pendant lights
- Material: glass
- Globe not included
- For indoor use only



Part No.	VINTAJ7-12
Description	PENDANT ES Ellipse Ribbed Glass w/ Brass + RND BLK Canopy
Material	Glass
Lamp holder	1xE27 (Max.72W)
Dimensions	Ø140 x H310mm
Suspension	3000mm black cable
Canopy size	Ø100 x 25mm
Carton QTY	1/1

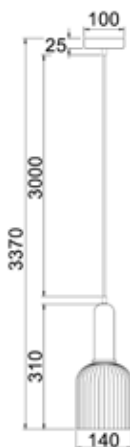



VINTAJ13
(Smokey Black Glass)



VINTAJ14
(Green Glass)



VINTAJ15
(Amber Glass)



VINTAJ16
(Copper Painted Glass)

- Interior dome ribbed glass pendant lights
- Material: glass
- Globe not included
- For indoor use only



Part No.	VINTAJ13-18
Description	PENDANT ES Dome Ribbed Glass w/ Brass + RND BLK Canopy
Material	Glass
Lamp holder	1xE27 (Max.72W)
Dimensions	Ø200 x H275mm
Suspension	3000mm black cable
Canopy size	Ø100 x 25mm
Carton QTY	1/1

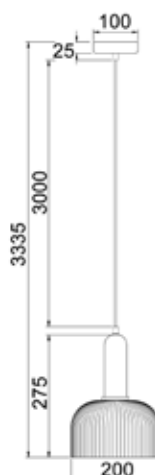

VINTAJ17
(Chrome Glass)



VINTAJ18
(Clear Glass)

BARRIQUE Interior Pendant Lights



BARRIQUE1
(Medium Oak Wood With Satin Brass Hardware)



BARRIQUE2
(Natural Wood With Oil Rubbed Bronze Hardware)

- Interior drum wood pendant lights
- Material: wood & iron
- Globe not included
- For indoor use only



Part No.	BARRIQUE1-2
Description	PENDANT ES 6 x 60W LGE Drum Wood With hardware
Material	wood
Lamp holder	6xE27 (Max.60W)
Dimensions	Ø624 x H427mm
Suspension	3000mm cable & chain
Canopy size	Ø120 x H25mm
Carton QTY	1/1

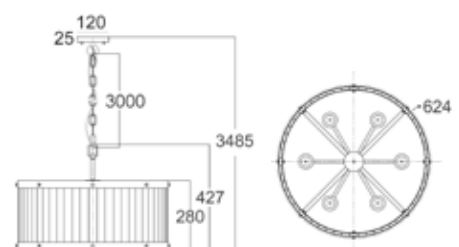



VOTIF Interior Pendant Lights



VOTIF1

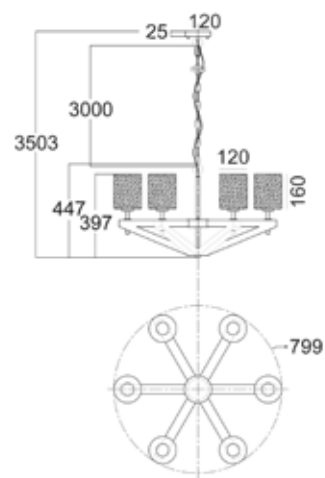

- Interior candelabra wood pendant light
- Material: wood, iron & glass
- Globe not included
- For indoor use only



Part No.	VOTIF1
Description	PENDANT ES 6 x 60W Candelabra Oak Wood Oil Rubbed Bronze Hardware & Clear blown Glass
Material	Wood, iron & glass
Lamp holder	6xE27 (Max.60W)
Dimensions	Ø799 x H447mm
Suspension	3000mm cable & chain
Canopy size	Ø120x 25mm
Carton QTY	1/1

DECOR LIGHTING

BANQUET Interior Pendant Lights



BANQUET1

- Interior rectangular wood frame pendant light
- Material: wood & iron
- Globe not included
- For indoor use only



Part No.	BANQUET1
Description	PENDANT ES 5 x 60W Rect Frame Medium Oak Wood With Oil Rubbed Bronze Hardware
Material	Wood & iron
Lamp holder	5x E27 (Max. 60W)
Dimensions	L1066 x W280 x H286mm
Suspension	3000mm cable & chain + 289mm rod
Canopy size	L400 x W130 x H20mm
Carton QTY	1/1

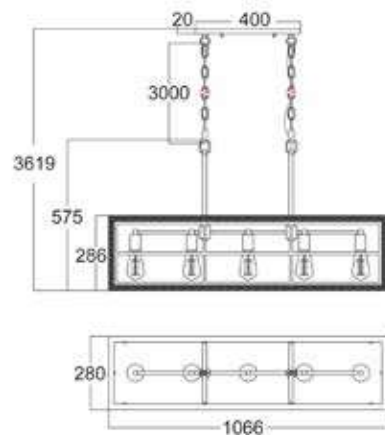

PELOTA Interior Pendant Lights





PELOTA1
(Smokey Black Glass)



PELOTA2
(Green Glass)



PELOTA3
(Amber Glass)



PELOTA4
(Copper Painted Glass)



PELOTA5
(Chrome Glass)



PELOTA6
(Clear Glass)

- Interior wine glass segmented glass pendant lights
- Material: glass
- Globe not included
- For indoor use only



Part No.	PELOTA1-6
Description	PENDANT ES Wine Glass Segmented Glass
Material	Glass
Lamp holder	1xE27 (Max.72W)
Dimensions	Ø200 x H320mm
Suspension	3000mm black cable
Canopy size	Ø100 x 25mm
Carton QTY	1/1

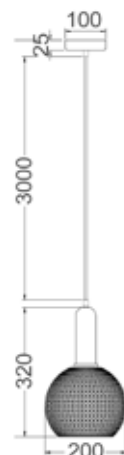

MARACA Interior Pendant Lights



MARACA1
(Smokey glass & Antique Brass Highlight)



MARACA2
(Green glass & Black Highlight)



MARACA3
(Amber glass & Black Highlight)



MARACA4
(Copper glass & Black Highlight)



MARACA5
(Matte gold glass & Antique Brass Highlight)

- Interior wine glass with quadrilateral segment pendant lights
- Material: glass
- Globe not included
- For indoor use only



Part No.	MARACA1-5
Description	PENDANT ES 72W Wine Glass with Quadrilateral Segment & Highlight
Material	Glass
Lamp Holder	1xE27 (Max.72W)
Dimensions	Ø200 x H295mm
Suspension	3000mm black cable
Canopy Size	Ø100 x 25mm
Carton QTY	1/1

MARBRE Interior Pendant Lights



MARBRE1
(Smokey Black)



MARBRE2
(Green)

- Interior wine glass wavy glass pendant lights
- Material: glass
- Globe not included
- For indoor use only



Part No.	MARBRE1-3
Description	PENDANT ES Wine Glass Wavy Glass
Material	Glass
Lamp Holder	1xE27 (Max.72W)
Dimensions	Ø170 x H180mm
Suspension	3000mm black cable
Canopy Size	Ø100 x 25mm
Carton QTY	1/1

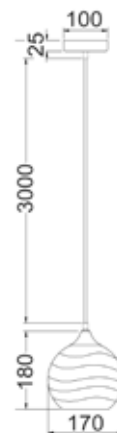

MARBRE3
(Amber)

DIABLO Interior Pendant Lights



DIABLO1
(Black)

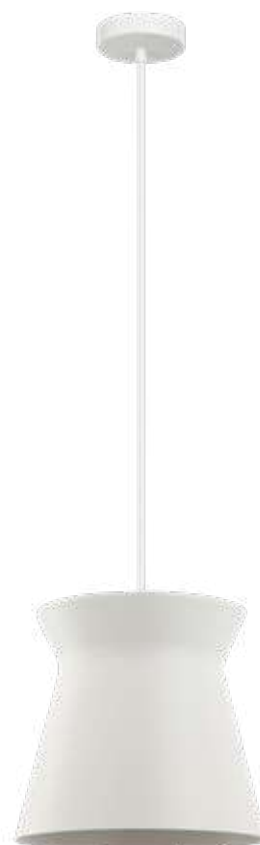

DIABLO2
(White)

- Interior cone flat top pendant lights
- Material: iron
- Globe not included
- For indoor use only



Part No.	DIABLO1-2
Description	PENDANT ES Cone Flat Top
Material	Iron
Lamp holder	1xE27 (Max.72W)
Dimensions	Ø250 x H235mm
Suspension	3000mm cable
Canopy size	Ø100 x 25mm
Carton QTY	1/1

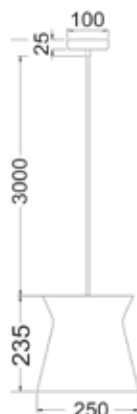

MANU Interior Pendant Lights



MANU1
(Black)



MANU2
(White)

- Interior cone (concave) cage pendant lights
- Material: iron
- Globe not included
- For indoor use only



Part No.	MANU1-2
Description	PENDANT ES Cone (Concave) Wire Cage
Material	Iron
Lamp holder	1xE27 (Max.72W)
Dimensions	Ø300 x H285mm
Suspension	3000mm cable
Canopy size	Ø100 x 25mm
Carton QTY	1/1

BROTE Interior Pendant Lights



BROTE1
(Amber glass & bronze highlight)



BROTE2
(Smokey black glass with black highlight)

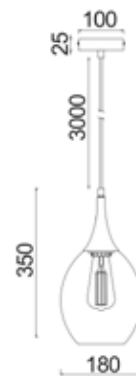

- Interior wine glass shape pendant lights
- Material: glass
- Globe not included
- For indoor use only



Part No.	BROTE1-2
Description	PENDANT ES 72W Wine Glass
Material	Glass
Lamp Holder	1xE27 (Max.72W)
Dimensions	Ø180 x H350mm
Suspension	3000mm PVC cable
Canopy Size	Ø100 x 25mm
Carton QTY	1/1

DECOR LIGHTING

MIKRO Interior Pendant Lights

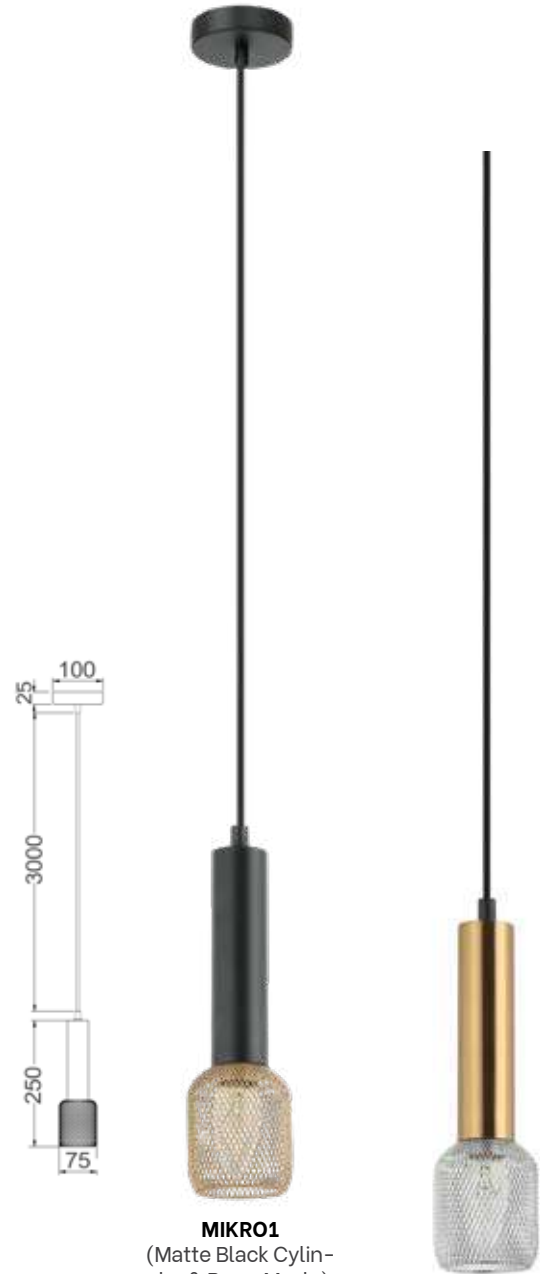

MIKRO1
(Matte Black Cylinder & Brass Mesh)

MIKRO2
(Antique Brass Cylinder & Chrome Mesh)

- Interior cylinder & mesh pendant lights
- Material: iron
- Globe not included
- For indoor use only



Part No.	MIKRO1-2
Description	PENDANT SES Cylinder & Mesh
Material	Iron
Lamp Holder	1xE14 (Max.40W)
Dimensions	Ø75 x H250mm
Suspension	3000mm PVC black cable
Canopy Size	Ø100 x 25mm
Carton QTY	1/1

GOLPE Interior Pendant Lights





- Interior oval stainless steel pendant lights
- Material: stainless steel
- Globe not included
- For indoor use only



Part No.	GOLPE1-4
Description	PENDANT ES 60W Oval BLK / Champagne Gold Sml/Lrg Stainless Steel
Material	Stainless steel
Lamp Holder	1xE27 (Max.60W)
Dimensions	GOLPE1-2: Ø400 x H250mm GOLPE3-4: Ø600 x H250mm
Suspension	3000mm PVC black cable
Canopy Size	Ø100mm
Carton QTY	1/1

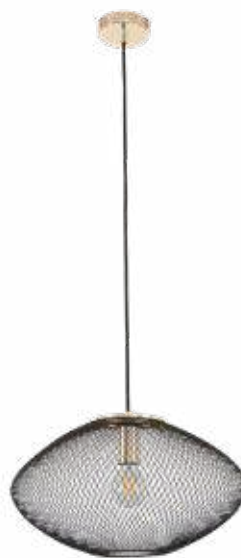

GOLPE1
(Black / Small)

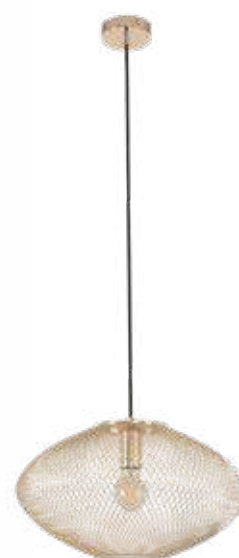

GOLPE2
(Champagne Gold / Small)

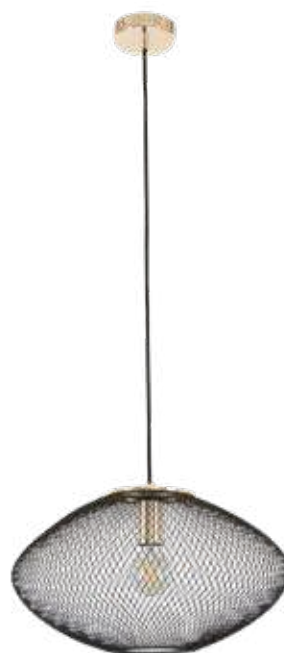

GOLPE3
(Black / Large)

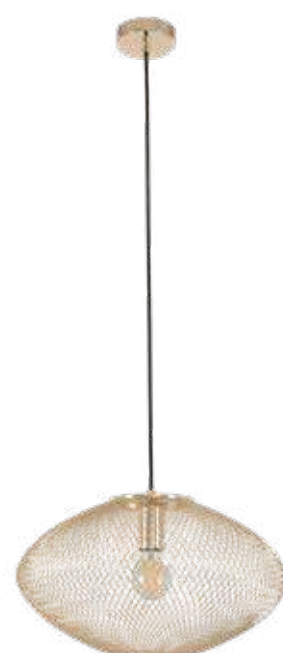

GOLPE4
(Champagne Gold / Large)

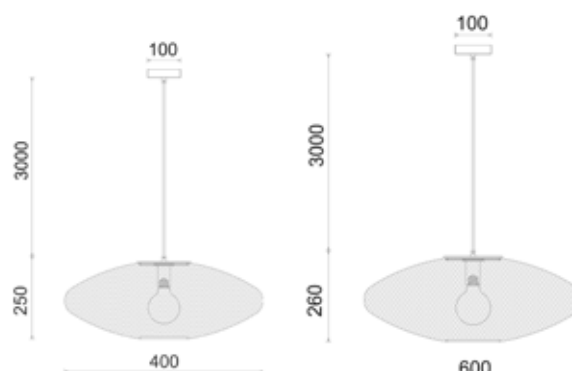

SARI Interior Pendant Lights



SARI1
(Aged Brass Steel/
Ombre internal effect)



SARI2
(Chrome Steel)

- Interior embossed ellipse pendant lights
- Material: metal
- Globe not included
- For indoor use only



Part No.	SARI2
Description	PENDANT ES 60W Embossed Ellipse
Material	Metal
Lamp holder	1xE27 (Max.60W)
Dimensions	Ø310 x H320mm
Suspension	3000mm black cable
Canopy size	Ø100x25mm
Carton QTY	1/1



DECOR LIGHTING

CANAMO Interior Pendant Lights



CANAMO1
(Ellipse shape)



CANAMO2
(Wine Glass shape)

- Interior hemp rope pendant lights
- Material: steel and hemp rope
- Globe not included
- For indoor use only



Part No.	CANAMO1-2
Description	PENDANT ES 40W Natural Hemp Rope & Black Hardware
Material	Steel & Hemp rope
Lamp holder	1xE27 (Max.40W)
Dimensions	CANAMO1: Ø300 x H320mm CANAMO2: Ø360 x H285mm
Suspension	3000mm black cable
Canopy size	Ø100mm
Carton QTY	1/1

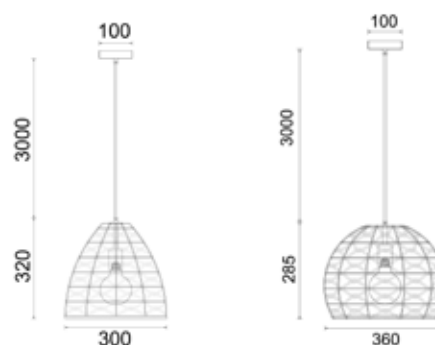

COUP Interior Pendant Lights



COUP1

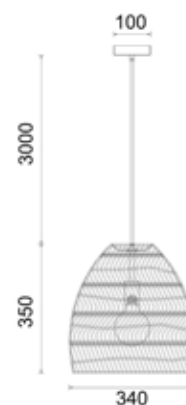

- Interior rattan ellipse pendant lights
- Material: rattan
- Globe not included
- For indoor use only



Part No.	COUP1
Description	PENDANT ES 60W Rattan Ellipse Matte Black
Material	Rattan
Lamp holder	1xE27 (Max.40W)
Dimensions	Ø340 x H350mm
Suspension	3000mm black cable
Canopy size	Ø100mm
Carton QTY	1/1

ROTA Interior Pendant Lights



ROTA1

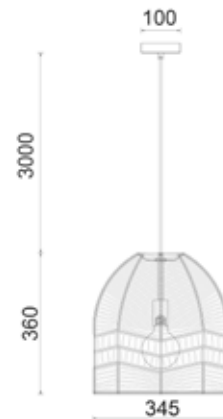

- Interior rattan ellipse pendant lights
- Material: rattan
- Globe not included
- For indoor use only



Part No.	ROTA1
Description	PENDANT ES 40W Natural Rattan Ellipse White
Material	Rattan
Lamp holder	1xE27 (Max.40W)
Dimensions	Ø345 x H360mm
Suspension	3000mm white cable
Canopy size	Ø100mm
Carton QTY	1/1

CESTA Interior Pendant Lights



CESTA1



DECOR LIGHTING

- Interior cylinder brown/natural bamboo cage pendant lights
- Material: bamboo
- Globe not included
- For indoor use only



Part No.	CESTA1
Description	PENDANT ES 40W Cylinder Natural/Brown Bamboo Cage With Blk Highlight & Cable
Material	Bamboo
Lamp holder	1xE27 (Max.40W)
Dimensions	Ø250 x H360mm
Suspension	3000mm black cable
Canopy size	Ø100mm
Carton QTY	1/1

CANASTA Interior Pendant Lights



CANASTA1
(Small)



CANASTA2
(Large)

- Interior bamboo finish pendant lights
- Material: bamboo
- Globe not included
- For indoor use only



Part No.	CANASTA1-2
Description	Pendant ES 40W Small/ Large Natural Bamboo Finish
Material	Bamboo
Lamp holder	1xE27 (Max.40W)
Dimensions	CANASTA1: Ø380 x H230mm CANASTA2: Ø450 x H260mm
Suspension	3000mm white cable
Canopy size	Ø100mm
Carton QTY	1/1

CEREMA Interior Pendant Lights



CEREMA1
(Ellipse Shape)



CEREMA2
(Angled Dome Shape)



CEREMA3
(Coolie Shape)



CEREMA4
(Small Coolie Shape)

- Interior white with antique brass and black highlight pendant lights
- Material: bamboo
- Globe not included
- For indoor use only



Part No.	CEREMA1-4
Description	PENDANT ES 40W WH With Antique Brass & BL Highlight
Material	Metal
Lamp holder	1xE27 (Max.40W)
Dimensions	CEREMA1: Ø205 x H235mm CEREMA2: Ø360 x H195mm CEREMA3: Ø360 x H215mm CEREMA4: Ø220 x H140mm
Suspension	3000mm white cable
Canopy size	Ø100mm
Carton QTY	1/1

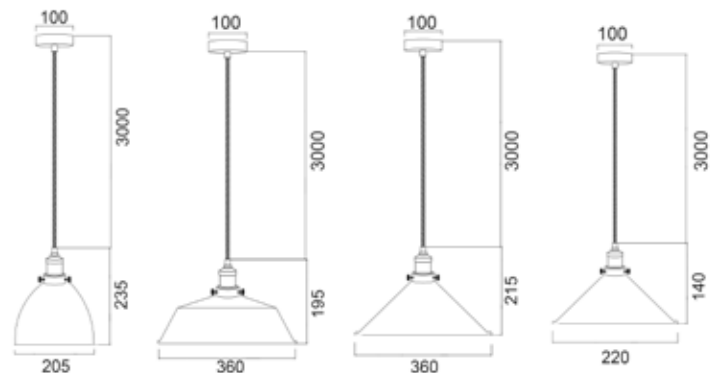

DECOR LIGHTING

PLIER Interior Pendant Lights

Adjustable shape & Custom Design



PLIER1-2



PLIER1
(Matte Copper)



PLIER2
(Chrome)



PLIER3-4



PLIER3
(Matte Copper)



PLIER4
(Chrome)

- Interior adjustable shape & custom design pendant lights
- Material: metal
- Globe not included
- For indoor use only



Part No.	PLIER1-4
Description	PENDANT ES 40W Adjustable Shape & Custom Design Steel
Material	Metal
Lamp holder	1xE27 (Max.40W)
Dimensions	PLIER1-2: Ø255-530 x H265-400mm PLIER3-4: Ø200-400 x H320-340mm
Suspension	3000mm cable
Canopy size	Ø100x25mm
Carton QTY	1/1

ORIGAMI Interior Pendant Lights





- Interior iron wine glass triangular tiled pendant lights
- Material: iron
- Globe not included
- For indoor use only

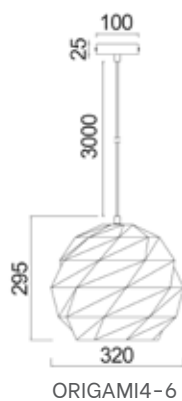
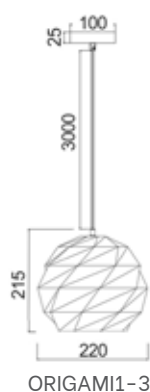

Part No.	ORIGAMI1-6
Description	PENDANT ES 72W SML/ LRG Wine Glass Triangular Tiled Iron
Material	Iron
Lamp holder	1xE27 (Max.72W)
Dimensions	ORIGAMI1-3: Ø220 x H215mm ORIGAMI4-6: Ø320 x H295mm
Suspension	3000mm PVC cable
Canopy size	Ø100 x 25mm
Carton QTY	1/1



ORIGAMI1
(White & white interior)



ORIGAMI4
(White & white interior)



ORIGAMI2
(Rose Gold & gold interior)



ORIGAMI5
(Rose Gold & gold interior)



ORIGAMI3
(Matte Grey & gold interior)



ORIGAMI6
(Matte Grey & gold interior)

TUILE Interior Pendant Lights





- Interior iron wine glass perforated(Diamond) tiles pendant lights
- Material: iron
- Globe not included
- For indoor use only



Part No.	TUILE1-6
Description	PENDANT ES 72W Wine Glass Perforated (Diamond) Tiles
Material	Iron
Lamp Holder	1xE27 (Max.72W)
Dimensions	TUILE1-3: Ø200 x H200mm TUILE4-6: Ø300 x H290mm
Suspension	3000mm PVC black cable
Canopy Size	Ø100 x 25mm
Carton QTY	1/1

*Product images have a warm white light source 'on'

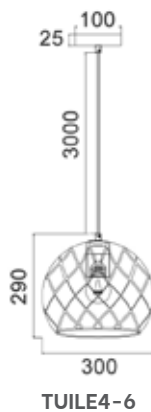
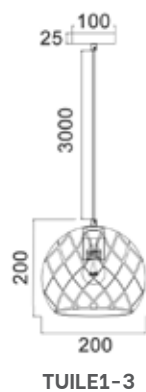

BOTANICA Interior Pendant Lights



BOTANICA01
(White & white interior)



BOTANICA02
(Black & black interior)



BOTANICA03
(Coffee & coffee interior)

- Interior iron dome perforated (Leaves) pendant lights
- Material: iron
- Globe not included
- For indoor use only



Part No.	BOTANICA01-03
Description	PENDANT ES 72W Dome Perforated (Leaves)
Material	Iron
Lamp Holder	1xE27 (Max.72W)
Dimensions	Ø300 x H240mm
Suspension	3000mm PVC cable
Canopy Size	Ø110 x 25mm
Carton QTY	1/1

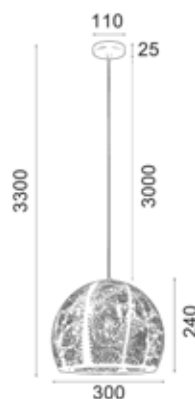

MARRAKESH Interior Pendant Lights



- Interior black iron pendant lights
- Material: iron
- Shade interior colour: gold
- Globe not included
- For indoor use only



Part No.	MARRAKESH01-05
Description	PENDANT ES 72W Perforated (Morrocan) BLK with Gold Interior
Material	Iron
Lamp Holder	1xE27 (Max.72W)
Dimensions	MARRAKESH01: Ø300 x H390mm MARRAKESH02: Ø300 x H280mm MARRAKESH03A: Ø400 x H200mm MARRAKESH04: Ø250 x H175mm MARRAKESH05: Ø160 x H510mm
Suspension	3000mm PVC black cable
Canopy Size	Ø110 x 25mm
Carton QTY	1/1

*Product images have a warm white light source 'on'



MARRAKESH01
(Margarita Glass shape)



MARRAKESH02
(Tear Drop shape)



MARRAKESH03A
(Dome shape)

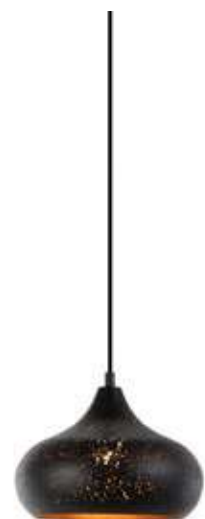

MARRAKESH04
(Margarita glass shape)

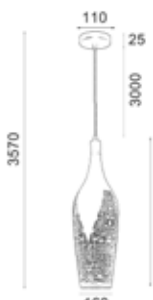
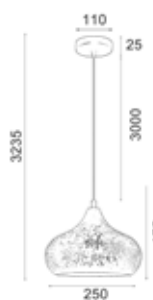
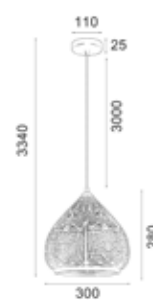
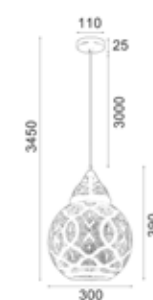

MARRAKESH05
(Bottle shape)

PATERA Interior Pendant Lights



PATERA1
(Clear glass)



PATERA2
(Smokey black glass)



PATERA3
(Amber glass)

- Interior glass with extended bronze highlight pendant lights
- Material: iron & glass
- Globe not included
- For indoor use only



DECOR LIGHTING

Part No.	PATERA1-3
Description	PENDANT ES 72W Wine Glass With Extended Bronze Highlight
Material	Iron & glass
Lamp Holder	1xE27 (Max.72W)
Dimensions	Ø300 x H380mm
Suspension	3000mm PVC cable
Canopy Size	Ø100 x 25mm
Carton QTY	1/1

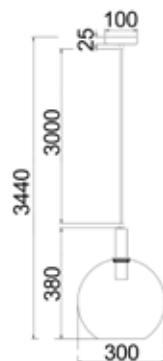

PESINI Interior Pendant Lights



- Interior glass with antique brass / chrome highlight pendant lights
- Material: iron & glass
- Globe not included
- For indoor use only



Part No.	PESINI1-6
Description	PENDANT ES 72W Wine Glass With Antique Brass / Chrome Highlight
Material	Iron & glass
Lamp Holder	1xE27 (Max.72W)
Dimensions	Ø250 x H290mm
Suspension	3000mm PVC cable
Canopy Size	Ø100 x 25mm
Carton QTY	1/1

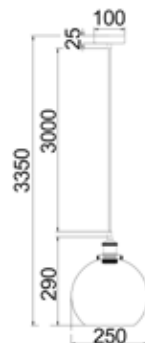

PESINI1
(Clear glass)



PESINI4
(Clear glass)



PESINI2
(Smokey black glass)



PESINI5
(Smokey black glass)



PESINI3
(Amber glass)



PESINI6
(Amber glass)

*PESINI interior wall lights are also available



VINUM Interior Pendant Lights



VINUM1
(Chrome glass)

VINUM2
(Copper coloured glass)

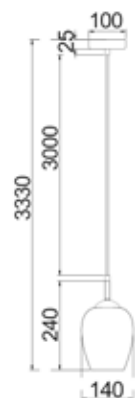

DECOR LIGHTING

- Interior wine glass shape with chrome highlight pendant lights
- Material: glass
- Globe not included
- For indoor use only



Part No.	VINUM1-2
Description	PENDANT ES 72W Wine Glass With Chrome Highlight
Material	Glass
Lamp Holder	1xE27 (Max.72W)
Dimensions	Ø140 x H240mm
Suspension	3000mm PVC cable
Canopy Size	Ø100 x 25mm
Carton QTY	1/1

*VINUM interior wall lights are also available



ROCHE Interior Pendant Lights



ROCHE1
(Crackled Matte Gold)

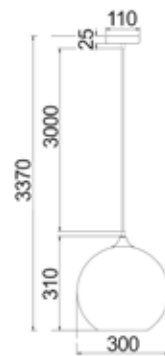

ROCHE2
(Crackled Satin Chrome)

- Interior wine glass shape pendant lights
- Material: glass
- Shade interior colour: white
- Globe not included
- For indoor use only



Part No.	ROCHE1-2
Description	PENDANT ES 72W Wine Glass With White Interior
Material	Glass
Lamp Holder	1xE27 (Max.72W)
Dimensions	Ø300 x H310mm
Suspension	3000mm black cable
Canopy Size	Ø110 x 25mm
Carton QTY	1/1

*Product images have a warm white light source 'on'





- Interior glass flat top cone pendant lights
- Material: iron & glass
- Globe not included
- For indoor use only



Part No.	JEREZ1, JEREZ1X3R, JEREZ1X3S JEREZ2, JEREZ2X3R, JEREZ2X3S
Description	PENDANT ES 72W Glass Flat Top Cone
Material	Iron & glass
Lamp Holder	JEREZ1/2: 1xE27 (Max.72W) JEREZ1/2X3R: 3xE27 (Max.72W) JEREZ1/2X3S: 3xE27 (Max.72W)
Dimensions	JEREZ1/2: Ø160 x H320mm JEREZ1/2X3R: Ø370mm JEREZ1/2X3S: L720 x H320mm
Suspension	3000mm PVC cable
Canopy Size	JEREZ1/2: Ø100 x 25mm JEREZ1/2X3R: Ø250 x 25mm JEREZ1/2X3S: L600 x 25mm
Carton QTY	1/1

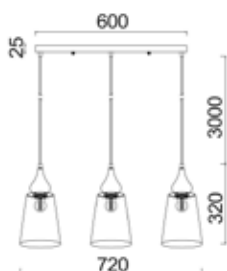

JEREZ1
(Amber glass)



JEREZ2
(Smokey black glass)

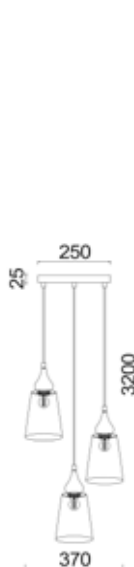

JEREZ1X3R
(Amber glass)



JEREZ2X3R
(Smokey black glass)



JEREZ1X3S
(Amber glass)



JEREZ2X3S
(Smokey black glass)

CHAMPAN Interior Pendant Lights





- Interior glass wine glass pendant lights
- Material: iron & glass
- Globe not included
- For indoor use only



Part No.	CHAMPAN1, CHAMPAN1X3R, CHAMPAN1X3S, CHAMPAN2, CHAMPAN2X3R, CHAMPAN2X3S
Description	PENDANT ES 72W Wine Glass
Material	Iron & glass
Lamp Holder	CHAMPAN1/2: 1xE27 (Max.72W) CHAMPAN1/2X3R: 3xE27 (Max.72W) CHAMPAN1/2X3S: 3xE27 (Max.72W)
Dimensions	CHAMPAN1/2: Ø145 x H215mm CHAMPAN1/2X3R: Ø355mm CHAMPAN1/2X3S: L625 x H215mm
Suspension	3000mm black cable
Canopy Size	CHAMPAN1/2: Ø100 x 25mm CHAMPAN1/2X3R: Ø250 x 25mm CHAMPAN1/2X3S: L530 x 25mm
Carton QTY	1/1

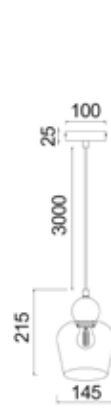
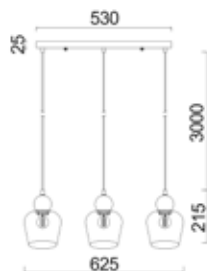

CHAMPAN1
(Amber glass)

CHAMPAN2
(Smokey black glass)



CHAMPAN1X3R
(Amber glass)

CHAMPAN2X3R
(Smokey black glass)



CHAMPAN1X3S
(Amber glass)

CHAMPAN2X3S
(Smokey black glass)

TRATTINO Interior Pendant Lights





TRATTINO1
(Amber glass)

TRATTINO2
(Smokey black glass)

- Interior sphere glass pendant lights
- Material: iron & glass
- Globe not included
- Globe size restriction: Ø42xL102mm
- Recommended globes: CLA candle/ fancy round globes
- For indoor use only



Part No.	TRATTINO1, TRATTINO1X3R, TRATTINO1X3S, TRATTINO2, TRATTINO2X3R, TRATTINO2X3S
Description	PENDANT ES 72W Glass Sphere
Material	Iron & glass
Lamp Holder	TRATTINO1/2: 1xE27 (Max.72W) TRATTINO1/2X3R: 3xE27 (Max.72W) TRATTINO1/2X3S: 3xE27 (Max.72W)
Dimensions	TRATTINO1/2: Ø150 x H360mm TRATTINO1/2X3R: Ø350mm TRATTINO1/2X3S: L640 x H360mm
Suspension	3000mm PVC cable
Canopy Size	TRATTINO1/2: Ø100 x 25mm TRATTINO1/2X3R: Ø250 x 25mm TRATTINO1/2X3S: L530 x 25mm
Carton QTY	1/1



TRATTINO1X3R
(Amber glass)

TRATTINO2X3R
(Smokey black glass)



TRATTINO1X3S
(Amber glass)

TRATTINO2X3S
(Smokey black glass)

TULIP Interior Pendant Lights





- Interior wine glass ribbed pendant lights
- Material: iron & glass
- Globe not included
- For indoor use only



Part No.	TULIP1, TULIP1X3R, TULIP1X3S TULIP2, TULIP2X3R, TULIP2X3S
Description	PENDANT ES 72W Wine Glass Ribbed With Brass / Black Highlight
Material	Iron & glass
Lamp Holder	TULIP1/2: 1xE27 (Max.72W) TULIP1/2X3R: 3xE27 (Max.72W) TULIP1/2X3S: 3xE27 (Max.72W)
Dimensions	TULIP1/2: Ø200 x H270mm TULIP1/2X3R: Ø455mm TULIP1/2X3S: L650 x H270mm
Suspension	3000mm black cable
Canopy Size	TULIP1/2: Ø100 x 25mm TULIP1/2X3R: Ø300 x 25mm TULIP1/2X3S: L650 x 25mm
Carton QTY	1/1

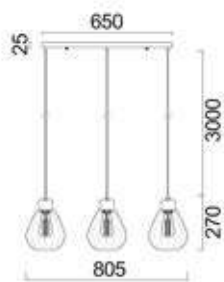

TULIP1
(Amber glass)



TULIP2
(Smokey black glass)



TULIP1X3R
(Amber glass)



TULIP2X3R
(Smokey black glass)



TULIP1X3S
(Amber glass)



TULIP2X3S
(Smokey black glass)

CIOTOLA Interior Pendant Lights



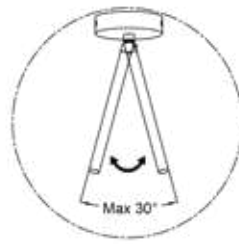

ROD TILT ANGLE MAX.30°

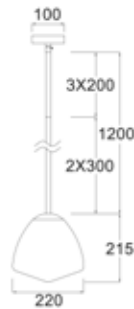

CIOTOLA1
(Matte black)



CIOTOLA2
(Antique brass)

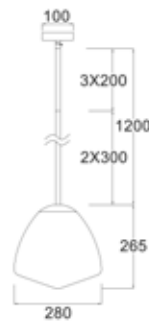

CIOTOLA3
(Matte black)



CIOTOLA4
(Antique brass)

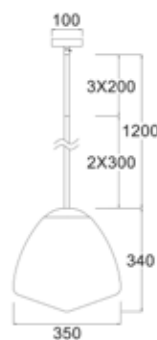

CIOTOLA5
(Matte black)



CIOTOLA6
(Antique brass)

- Interior cone (Concave) tipped opal glass pendant lights
- Material: opal glass & iron
- Globe not included
- Globe size restrictions (max. diameter):
CIOTOLA1-2: 40mm; CIOTOLA3-4: 50mm;
CIOTOLA5-6: 70mm
- Rod tilt angle: max.30°
- For indoor use only



Part No.	CIOTOLA1-6
Description	PENDANT ES 40W Cone (Concave) Tipped Opal Glass
Material	Glass & iron
Lamp Holder	1xE27 (Max.40W)
Dimensions	CIOTOLA1-2: Ø220 x H215mm CIOTOLA3-4: Ø280 x H265mm CIOTOLA5-6: Ø350 x H340mm
Suspension	3x200mm + 2x300mm rods (Note: rods can be removed to reach desired length)
Canopy Size	Ø100 x 25mm
Carton QTY	1/1

ESPEJO Interior Pendant Lights





- Interior line effect cylinder pendant lights
- Material: glass & iron
- Globe not included
- For indoor use only



Part No.	ESPEJO1, ESPEJO1X3R, ESPEJO1X3S ESPEJO2, ESPEJO2X3R, ESPEJO2X3S
Description	PENDANT ES 72W Glass With Line Effect Cylinder
Material	Iron & glass
Lamp Holder	ESPEJO1/2: 1xE27 (Max.72W) ESPEJO1/2X3R: 3xE27 (Max.72W) ESPEJO1/2X3S: 3xE27 (Max.72W)
Dimensions	ESPEJO1/2: Ø120 x H325mm ESPEJO1/2X3R: Ø330mm ESPEJO1/2X3S: L600 x H325mm
Suspension	3000mm PVC cable
Canopy Size	ESPEJO1/2: Ø100 x 25mm ESPEJO1/2X3R: Ø250 x 25mm ESPEJO1/2X3S: L530 x 25mm
Carton QTY	1/1

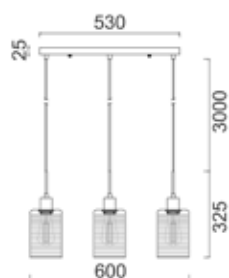





- Interior dotted effect cylinder pendant lights
- Material: glass & iron
- Globe not included
- For indoor use only



Part No.	ESPEJO3, ESPEJO3X3R, ESPEJO3X3S ESPEJO4, ESPEJO4X3R, ESPEJO4X3S
Description	PENDANT ES 72W Glass With Dotted Effect cylinder
Material	Iron & glass
Lamp Holder	ESPEJO3/4: 1xE27 (Max.72W) ESPEJO3/4X3R: 3xE27 (Max.72W) ESPEJO3/4X3S: 3xE27 (Max.72W)
Dimensions	ESPEJO3/4: Ø120 x H325mm ESPEJO3/4X3R: Ø330mm ESPEJO3/4X3S: L600 x H325mm
Suspension	3000mm PVC cable
Canopy Size	ESPEJO3/4: Ø100 x 25mm ESPEJO3/4X3R: Ø250 x 25mm ESPEJO3/4X3S: L530 x 25mm
Carton QTY	1/1

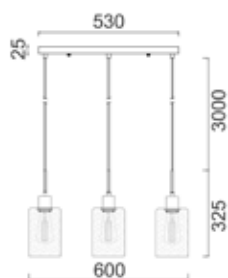

FOSSETTE Interior Pendant Lights



FOSSETTE1
(Angled bell)

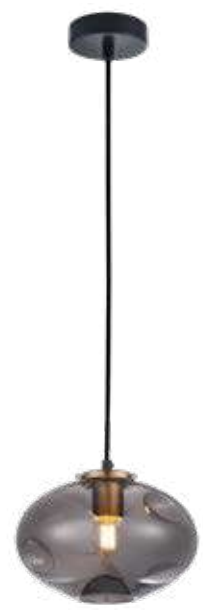

FOSSETTE2
(Oval)



FOSSETTE3
(Sami Sphere dome)



FOSSETTE4
(Ellipse)

- Interior dimpled smokey glass pendant lights
- Material: glass & iron
- Globe not included
- Globe size restriction(max. diameter): 45mm
- For indoor use only



Part No.	FOSSETTE1-4
Description	PENDANT ES 40W Smokey Glass with Antique Brass Highlights
Material	Glass & iron
Lamp Holder	1xE27 (Max.40W)
Dimensions	FOSSETTE1: Ø170 x H180mm FOSSETTE2: Ø220 x H170mm FOSSETTE3: Ø220 x H215mm FOSSETTE4: Ø175 x H295mm
Suspension	3000mm PVC cable
Canopy Size	Ø100 x 25mm
Carton QTY	1/1

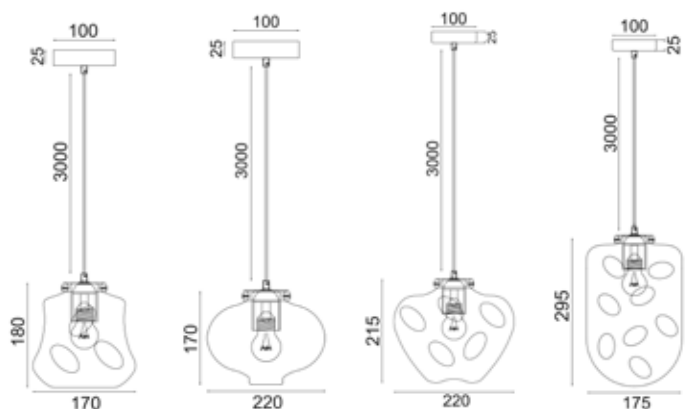

*Product images have a warm white light source 'on'

DECOR LIGHTING

MARTE Interior Pendant Lights



MARTE1
(Black iron cage with Brass highlight)



MARTE2
(Matte gold Iron Cage with Black highlight)



MARTE3
(White iron cage with Brass highlight)

- Interior bell wire iron pendant lights
- Material: iron
- Globe not included
- For indoor use only



Part No.	MARTE1-3
Description	PENDANT ES 72W Iron Bell Wire With Highlight
Material	Iron
Lamp Holder	1xE27 (Max.72W)
Dimensions	Ø395 x H350mm
Suspension	3000mm cable
Canopy Size	Ø100 x 25mm
Carton QTY	1/1

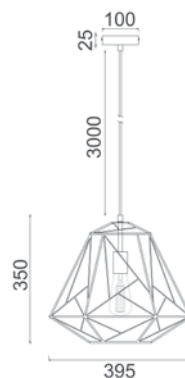

VAINA Interior Pendant Lights



VAINA1
(Matte Black)

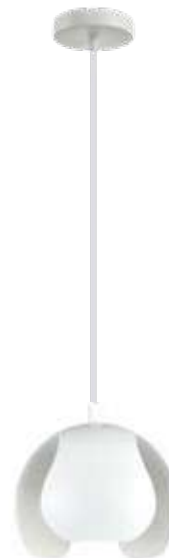

VAINA2
(Matte White)



VAINA3
(Matte Gold)



VAINA4
(Antique Copper)

- Interior wine glass with three petals pendant lights
- Material: iron
- Globe not included
- For indoor use only



Part No.	VAINA1-4
Description	PENDANT ES 72W Wine Glass with Three Petals
Material	Iron
Lamp Holder	1xE27 (Max.72W)
Dimensions	Ø150 x H155mm
Suspension	3000mm PVC cable
Canopy Size	Ø100 x 25mm
Carton QTY	1/1

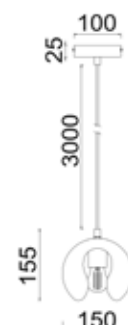

DECOR LIGHTING

BELLA Interior Pendant Lights



BELLA1
(Matte white)



BELLA2
(Matte black)



BELLA3
(Matte gold)

- Interior wine glass iron pendant lights
- Material: iron
- Shade interior colour: matte gold
- Globe not included
- For indoor use only



**Matte gold interior*

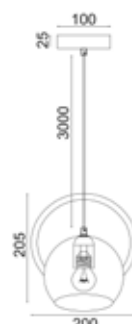

Part No.	BELLA1-3
Description	PENDANT ES 72W Wine Glass with Matte Gold Interior
Material	Iron
Lamp Holder	1xE27 (Max.72W)
Dimensions	Ø200 x H205mm
Suspension	3000mm PVC cable
Canopy Size	Ø100 x 25mm
Carton QTY	1/1

**Product images have a warm white light source 'on'*

ESCAMA Interior Pendant Lights



ESCAMA1
(Black)



ESCAMA2
(White)

- Interior iron ellipse perforated (triangles) pendant lights
- Material: iron
- Globe not included
- For indoor use only



Part No.	ESCAMA1-2
Description	PENDANT ES 72W Iron Ellipse Perforated (Triangles)
Material	Iron
Lamp Holder	1xE27 (Max.72W)
Dimensions	Ø140 x H225mm
Suspension	3000mm PVC cable
Canopy Size	Ø100 x 25mm
Carton QTY	1/1

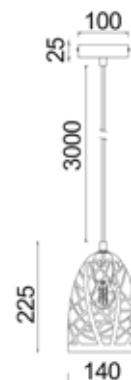

DECOR LIGHTING

CLEO Interior Pendant Lights



CLEO1
(Cut glass)

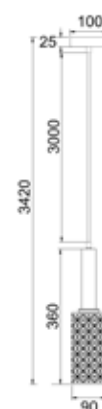

- Interior cylinder clear embossed glass pendant light
- Material: iron & glass
- Globe not included
- Globe size restriction: only candle shaped globes will fit
- For indoor use only

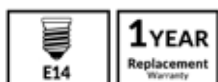

Part No.	CLEO1
Description	PENDANT SES 72W Cylinder Clear Embossed Glass with Matt Black & Brass Highlight
Material	Iron & glass
Lamp Holder	1xE14 (Max.72W)
Dimensions	Ø90 x H360mm
Suspension	3000mm PVC cable
Canopy Size	Ø100 x 25mm
Carton QTY	1/1

*Product images have a warm white light source 'on'

PASTILLE Interior Pendant Lights



PASTILLE1
(Smokey glass & Satin Chrome highlight)



PASTILLE2
(Amber glass & Antique brass highlight)

- Interior cylinder pendant lights
- Material: iron & glass
- Globe not included
- Globe size restriction (max.diameter): 60mm
- For indoor use only



Part No.	PASTILLE1-2
Description	PENDANT ES 72W Cylinder with Highlight
Material	Iron & glass
Lamp Holder	1xE27 (Max.72W)
Dimensions	Ø80 x H300mm
Suspension	3000mm PVC cable
Canopy Size	Ø100 x 25mm
Carton QTY	1/1

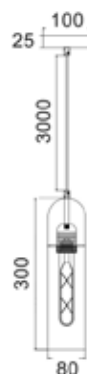

**Product images have a warm white light source 'on'*

PAPILLON Interior Pendant Lights



PAPILLON1
(Matte black & clear glass)



PAPILLON2
(Antique Brass & Amber glass)

- Interior coolie with oval glass pendant lights
- Material: iron & glass
- Globe not included
- Globe size restriction (max diameter): 95mm(G95)
- For indoor use only

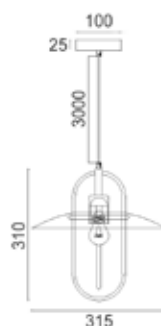

Part No.	PAPILLON1-2
Description	PENDANT ES 72W Coolie with Oval Glass
Material	Iron & glass
Lamp Holder	1xE27 (Max.72W)
Dimensions	Ø315 x H310mm
Suspension	3000mm PVC cable
Canopy Size	Ø100 x 25mm
Carton QTY	1/1

CHAPEAU Interior Pendant Lights

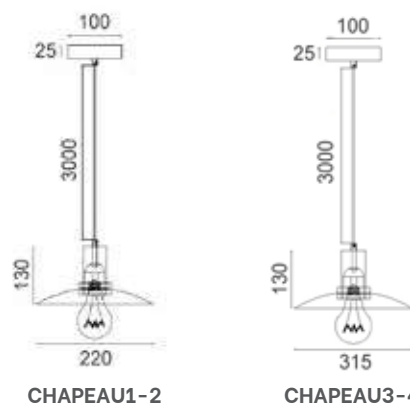

- Interior glass coolie pendant lights
- Material: iron & glass
- Globe not included
- For indoor use only



Part No.	CHAPEAU1-4
Description	PENDANT ES 72W Glass Coolie with Highlight
Material	Iron & glass
Lamp Holder	1xE27 (Max.72W)
Dimensions	CHAPEAU1-2: Ø220 x H130mm CHAPEAU3-4: Ø315 x H130mm
Suspension	3000mm PVC cable
Canopy Size	Ø100 x 25mm
Carton QTY	1/1

CONTOUR Interior Pendant Lights



- Interior black wire pendant lights
- Material: iron
- Globe not included
- Globe size restrictions (max.diameter): CONTOUR1: 125mm (G125); CONTOUR2: 57mm (ST57); CONTOUR3: 95mm (G95)
- For indoor use only



Part No.	CONTOUR1-3
Description	PENDANT ES 72W BLK WIRE with Antique Brass Highlight
Material	Iron
Lamp Holder	1xE27 (Max.72W)
Dimensions	CONTOUR1: W170 x H290mm CONTOUR2: W150 x H360mm CONTOUR3: W210 x H360mm
Suspension	3000mm PVC cable
Canopy Size	Ø100 x 25mm
Carton QTY	1/10

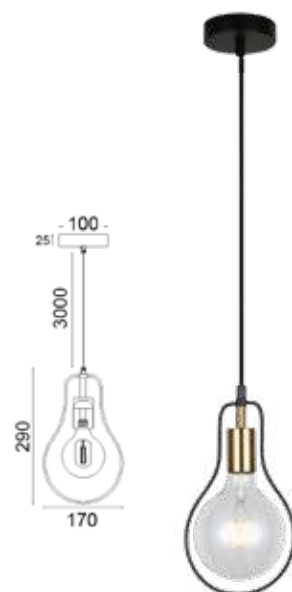

CONTOUR1
(Pear shape)

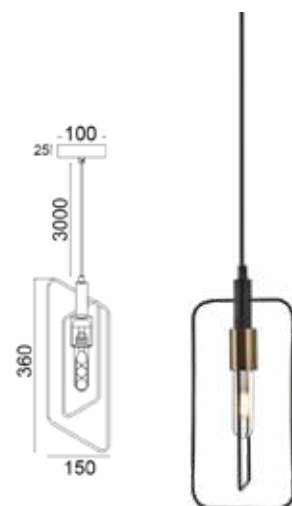

CONTOUR2
(Rectangular shape)

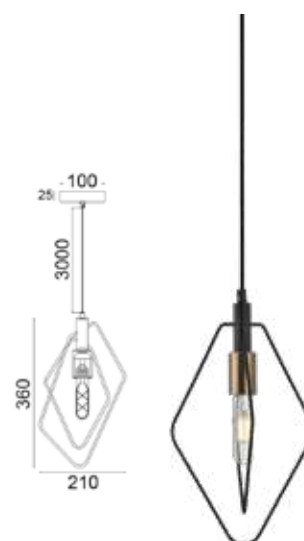

CONTOUR3
(Diamond shape)

IDA Interior Pendant Lights



IDA1
(Matte Black/ Blonde wood)



IDA2
(Matte White/ Blonde wood)

- Interior cylinder pendant lights
- Material: iron & blonde wood
- Globe not included
- For indoor use only



Part No.	IDA1-2
Description	PENDANT ES 72W Iron with Blonde Wood Cylinder
Material	Iron & wood
Lamp Holder	1xE27 (Max.72W)
Dimensions	Ø50 x H250mm
Suspension	3000mm PVC cable
Canopy Size	Ø100 x 25mm
Carton QTY	1/10

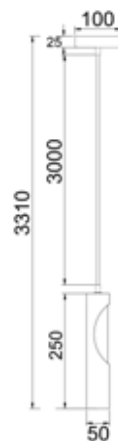

DECOR LIGHTING

GOLDA Interior Pendant Lights



- Interior cylinder pendant lights
- Material: iron
- Globe not included
- For indoor use only



Part No.	GOLDA1-2
Description	PENDANT ES 72W Matte Black Diagonal/ Vertical Antique Brass Feature Cylinder
Material	Iron
Lamp Holder	1xE27 (Max.72W)
Dimensions	Ø50 x H250mm
Suspension	3000mm PVC cable
Canopy Size	Ø100 x 25mm
Carton QTY	1/10

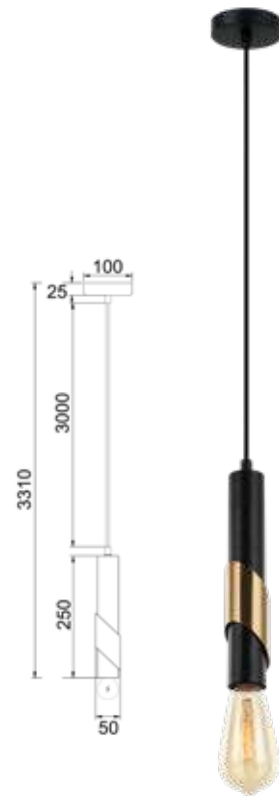

GOLDA1
(Matte Black/ Diagonal
Antique Brass Feature)

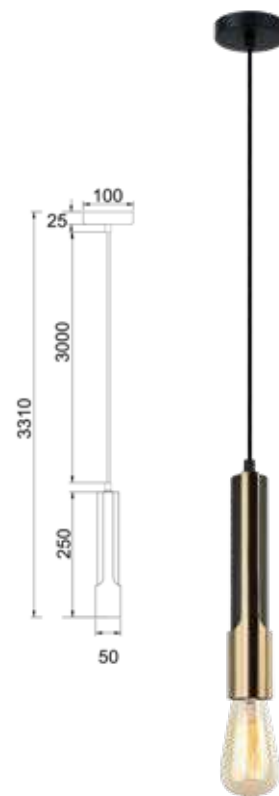

GOLDA2
(Matte Black/ Vertical
Antique Brass Feature)

CORAZON Interior Pendant Lights



CORAZON1
(Matte black/ copper diamond wire)

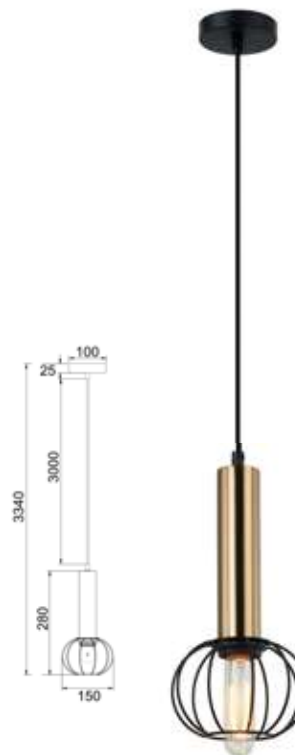

CORAZON2
(Antique brass/ matte black sphere wire)

- Interior diamond / sphere wire pendant lights
- Material: iron
- Globe not included
- Globe size restrictions (max.diameter): 60mm(GLS)
- For indoor use only



Part No.	CORAZON1-2
Description	CORAZON1: PENDANT ES 72W Matt black Copper Diamond Wire CORAZON2: PENDANT ES 72W Antique Brass Matt Black Sphere Wire
Material	Iron
Lamp Holder	1xE27 (Max.72W)
Dimensions	Ø150 x H280mm
Suspension	3000mm PVC cable
Canopy Size	Ø100 x 25mm
Carton QTY	1/10

DECOR LIGHTING

METEORA Interior Pendant Lights



METEORA1



- Interior octagon stainless steel with silver glass beaten sphere feature pendant light
- Material: iron, stainless steel & glass
- Globe not included
- For indoor use only



Part No.	METEORA1
Description	PENDANT ES 60W Octagon SS with Silver Glass Beaten Sphere Feature
Material	Iron, stainless steel & glass
Lamp Holder	1xE27 (Max.60W)
Dimensions	Ø450 x H518mm
Suspension	3000mm cable & chain
Canopy Size	Ø135 x 23mm
Carton QTY	1/1

ABBEY Interior Pendant Lights





ABBEY1
(Matte black)



ABBEY2
(Matte gold)

- Interior candelabra pendant lights
- Material: iron & opal glass
- Globe not included
- For indoor use only



Part No.	ABBEY1-2
Description	PENDANT ES x 6 72W Candelabra
Material	Iron, opal glass
Lamp Holder	6xE27 (Max.72W)
Dimensions	Ø675 x H250mm
Suspension	300mm rod
Canopy Size	Ø110 x 25mm
Carton QTY	1/1

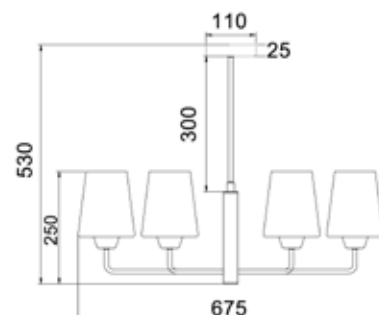

HEXADE Interior Pendant Lights



HEXADE1
(Matte black)



HEXADE2
(Matte gold)

- Interior candelabra pendant lights
- Material: iron
- Globe not included
- For indoor use only



Part No.	HEXADE1-2
Description	PENDANT ES x 16 72W Candelabra
Material	Iron
Lamp Holder	16xE27 (Max.72W)
Dimensions	Ø505 x H460mm
Suspension	500mm rod
Canopy Size	Ø120 x 25mm
Carton QTY	1/1

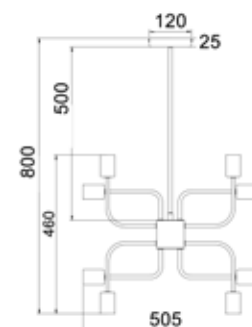

**Product images have a warm white light source 'on'*

HEXA Interior Pendant Lights



HEXA1
(Matte black)



HEXA2
(Matte gold)

- Interior candelabra pendant lights
- Material: iron
- Globe not included
- For indoor use only



Part No.	HEXA1-2
Description	PENDANT ES x 6 72W Candelabra
Material	Iron
Lamp Holder	6xE27 (Max.72W)
Dimensions	Ø420mm
Suspension	300mm rod
Canopy Size	Ø120 x 25mm
Carton QTY	1/1

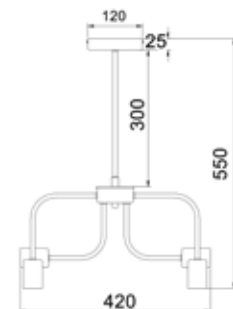

*Product images have a warm white light source 'on'

STRATO Interior Pendant Lights





STRATO1

- Interior oval & tube stainless steel and round stepped with polished nickel pendant light
- Material: iron & stainless steel
- Globe not included
- Suitable for E14 base candle globes only
- For indoor use only



Part No.	STRATO1
Description	PENDANT Oval & Tube SS + Round Stepped with Polished Nickel + RND Stepped Pol/Nickel Canopy
Material	Iron, stainless steel
Lamp Holder	10xE14 (Max.60W)
Dimensions	Ø604 x H446mm
Suspension	3000mm chrome colour cable & chain
Canopy Size	Ø135 x 23mm
Carton QTY	1/1

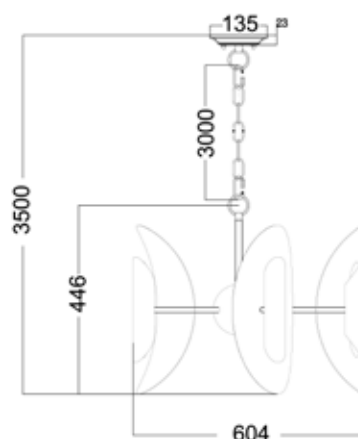

ORBITA Interior Pendant Lights



ORBITA1
(Polished Nickel Hardware with SS)

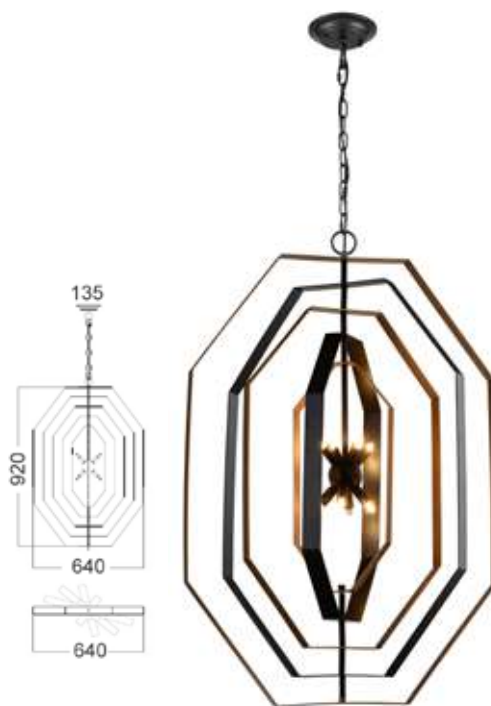

ORBITA2
(Oil Rubbed Bronze Hardware with Antique Gold)

- Interior octagon pendant lights
- Material: stainless steel with polished nickel OR rubbed bronze and antique gold
- Globe not included
- For indoor use only

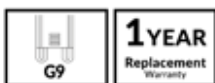

Part No.	ORBITA1
Description	PENDANT Polished Nickel Hardware with Stainless Steel + RND Stepped Pol/Nickel Canopy
Material	Iron & stainless steel
Lamp Holder	4xG9 (Max.40W)
Dimensions	W360 x H640mm
Suspension	3000mm cable & chain
Canopy Size	Ø135 x 23mm
Carton QTY	1/1

Part No.	ORBITA2
Description	PENDANT Oil Rubbed Bronze Hardware with Antique Gold + RND Stepped Oiled BRZ Canopy
Material	Iron
Lamp Holder	8xG9 (Max.40W)
Dimensions	W640 x H920mm
Suspension	3000mm cable & chain
Canopy Size	Ø135 x 23mm
Carton QTY	1/1

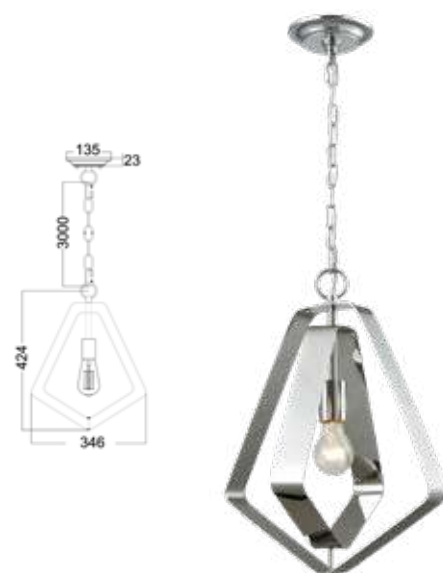

ORBITA3



ORBITA4

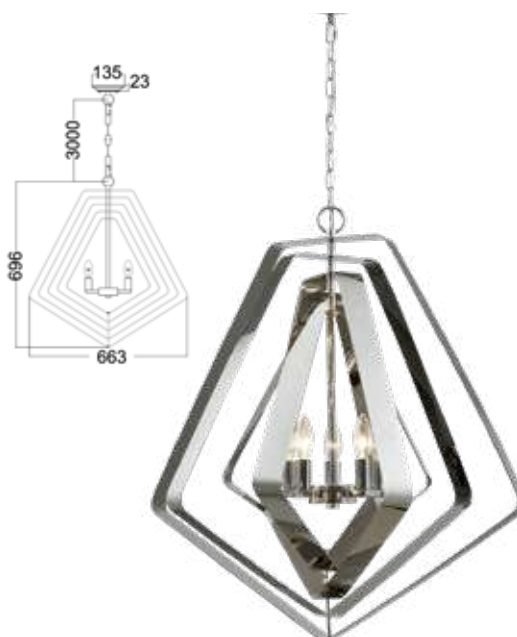

ORBITA5

- Interior stainless steel pendant lights
- Material: stainless steel
- Globe not included
- For indoor use only



Part No.	ORBITA3-5
Description	PENDANT Polished Nickel Hardware with Stainless Steel + RND Stepped Pol/Nickel Canopy
Material	Stainless steel
Lamp Holder	ORBITA3: 1xE27 (Max.60W) ORBITA4: 3xE14 (Max.60W) ORBITA5: 5xE14 (Max.60W)
Dimensions	ORBITA3: Ø346 x H424mm ORBITA4: Ø505 x H565mm ORBITA5: Ø663 x H696mm
Suspension	3000mm chrome cable & chain
Canopy Size	Ø135 x 23mm
Carton QTY	1/1

SPUTNIK Interior Pendant Lights



SPUTNIK1

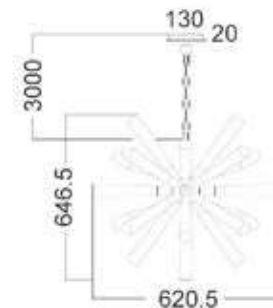

- Interior sea anemone dark grey & washed wood with nickel pendant light
- Material: polished nickel & wood
- Globe not included
- For indoor use only



*SPUTNIK2 interior wall light is also available



Part No.	SPUTNIK1
Description	PENDANT ESX6 60W Sea Anemone Dark Grey & Washed Wood w/Nickel + RND Nickel Canopy
Material	Polished nickel, wood
Lamp Holder	6xE27 (Max.60W)
Dimensions	Ø620.5 x H646.5mm
Suspension	3000mm cable & chain
Canopy Size	Ø130 x 20mm
Carton QTY	1/1

MAZZA Interior Pendant Lights



MAZZA

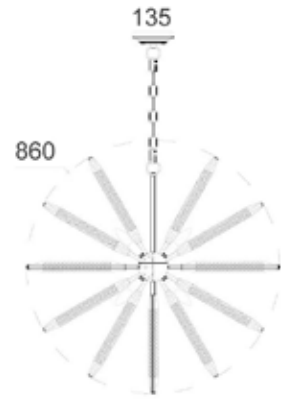

- Interior sea anemone natural rope with Weathered Zinc pendant light
- Material: natural rope with weathered zinc
- Globe not included
- Recommended globes: CLA E14 base candle globes
- For indoor use only

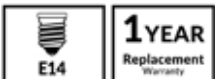

Part No.	MAZZA
Description	PENDANT SES x 8 60W Sea Anemone Natural Rope with Weathered Zinc + RND Stepped W/Zinc Canopy
Material	Iron, natural rope
Lamp Holder	8xE14 (Max.60W)
Dimensions	Ø860 x H860mm
Suspension	3000mm cable & chain
Canopy Size	Ø135 x 23mm
Carton QTY	1/1

HOPI Interior Pendant Lights



HOPI01

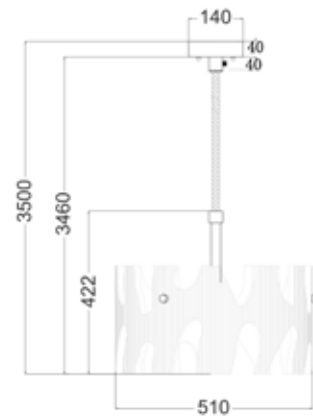

DECOR LIGHTING

- Interior drum weathered grey wood pendant light
- Shade: weathered grey wood
- Globe not included
- Not suitable for use with any globe larger than GLS
- For indoor use only



Part No.	HOPI01
Description	PENDANT ES 3 x 60W Drum Weathered Grey Wood + RND BRZ Canopy
Material	Wood, bronzed iron & rope
Lamp Holder	3xE27 (Max.60W)
Dimensions	Ø510 x H422mm
Suspension	Bronze iron rod + 3000mm rope
Canopy Size	Ø140 x 40mm
Carton QTY	1/1

METI Interior Pendant Lights



METI01



METI02

- Interior rectangular / bar pendant lights
- Material: iron, wood & glass
- Oil rubbed bronze rods+trim+mounted plates
- Globe not included
- For indoor use only



Part No.	METI01-02
Description	PENDANT ES 60W Warm Chestnut Wood Frame Rect / Bar Clear Glass Shades Oil Rubbed Bronze Hardware
Material	Iron, wood & glass
Lamp Holder	METI01: 6xE27 (Max.60W) METI02: 4xE27 (Max.60W)
Dimensions	METI01: L1035 x W380mm METI02: L1280 x W150mm
Suspension	METI01: Rod, see line drawing (Min:305mm; Max: 1067mm) METI02: Rod, see line drawing (Any combination of rods can be used)
Canopy Size	L435 x W140 x D22mm
Carton QTY	1/1

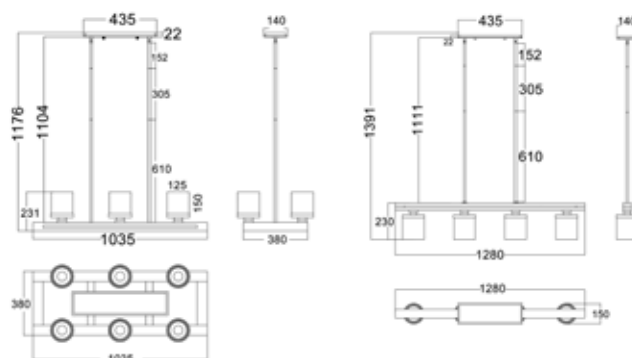

*METI interior wall light is also available



BONITO Interior Pendant Lights



- Interior tear drop wood pendant lights
- Material: nickel & taupe OR winter moss finished wood
- Globe not included
- For indoor use only



NOTE:

(1) Adjustable knuckle(45°). Suitable for raked ceiling.

(2) Can be mounted with any combination of short and long rods.

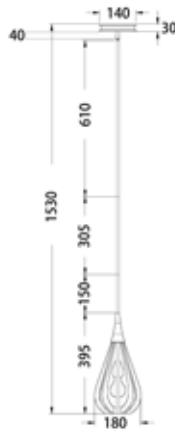

BONITO1
(Taupe wood)



BONITO6
(Winter Moss Wood)

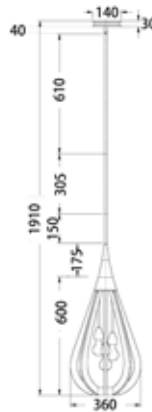

BONITO2
(Taupe wood)



BONITO7
(Winter Moss Wood)

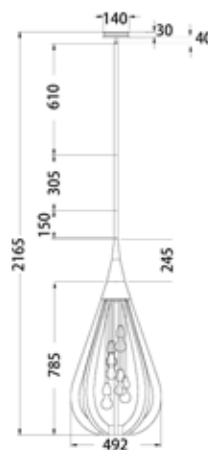

BONITO3
(Taupe wood)



BONITO8
(Winter moss wood)

Part No.	BONITO1-3 & BONITO6-8
Description	PENDANT ES Wood SML/ MED/ LGE Tear Drop w/Nickel + Rods + RND Nickel Canopy
Material	Nickel & wood
Lamp Holder	BONITO1&6: 1xE27 (Max.60W) BONITO2&7: 3xE27 (Max.60W) BONITO3&8: 6xE27 (Max.60W)
Dimensions	BONITO1&6: Ø180 x H395mm BONITO2&7: Ø360 x H775mm BONITO3&8: Ø492 x H1030mm
Suspension	150+3305+610mm rods
Canopy Size	Ø140x30mm
Carton QTY	1/1

KHALESSI Interior Pendant Lights



KHALESSI1



KHALESSI2



KHALESSI3

- Interior dark red oak wood bell pendant lights
- Material: oak dark red wood with oiled bronze hardware
- Globe not included
- For indoor use only



Part No.	KHALESSI1-3
Description	PENDANT Oak Dark Red Wood SML/ MED/ LGE Bell + RND Stepped Oiled BRZ Canopy
Material	Iron & wood
Lamp Holder	KHALESSI1: 1xE27 (Max.60W) KHALESSI2: 3xE27 (Max.60W) KHALESSI3: 5xE27 (Max.60W)
Dimensions	KHALESSI1: Ø226 x H462mm KHALESSI2: Ø391 x H711mm KHALESSI3: Ø535 x H982mm
Suspension	3000mm chain & cable
Canopy Size	Ø135x23mm
Carton QTY	1/1

SENORITA Interior Pendant Lights



- Interior wood arrow shape pendant lights
- Shade: ashtree / cherry wood
- Colour: Tuscan coffee/ Winter moss
- Globe not included
- For indoor use only



Part No.	SENORITA1-6
Description	PENDANT ES Wood SML/ MED/ LGE Arrow + RND Stepped Oiled Brz / Polished Nickel Canopy
Material	Wood
Lamp Holder	SENORITA1&4: 1xE27 (Max.60W) SENORITA2&5: 3xE27 (Max.60W) SENORITA3&6: 6xE27 (Max.60W)
Dimensions	SENORITA1&4: Ø248 x H442mm SENORITA2&5: Ø420 x H790mm SENORITA3&6: Ø588 x H1087mm
Suspension	3000mm chain & cable
Canopy Size	Ø135x23mm
Carton QTY	1/1

*Some assembly **MAY BE** required

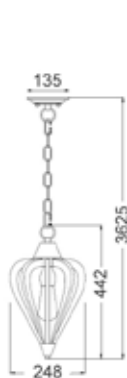

SENORITA1
(Tuscan Coffee Cherry Wood)



SENORITA4
(Winter Moss Wood)

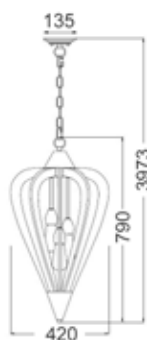

SENORITA2
(Tuscan Coffee Cherry Wood)



SENORITA5
(Winter Moss Wood)

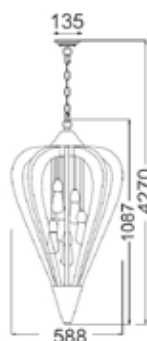

SENORITA3
(Tuscan Coffee Cherry Wood)



SENORITA6
(Winter Moss Wood)

PENDOLO Interior Pendant Lights



PENDOLO1
(Weathered charcoal
Hardware & washed wood)



PENDOLO2
(Satin Brass Hardware &
Dark wood)

- Interior ellipse caged wood and clear diffuser pendant lights
- Shade: iron, wood & glass
- Globe not included
- For indoor use only



Part No.	PENDOLO1-2
Description	PENDANT ES X 1 Ellipse Caged Wood and Clear Diffuser + RND St Charcoal / Br Canopy
Material	Wood, iron & glass
Lamp Holder	1xE27 (Max.60W)
Dimensions	Ø180 x H517mm
Suspension	3000mm chain & cable
Canopy Size	Ø135x23mm
Carton QTY	1/1

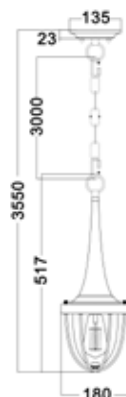

DECOR LIGHTING

AUTUMN Interior Pendant Lights

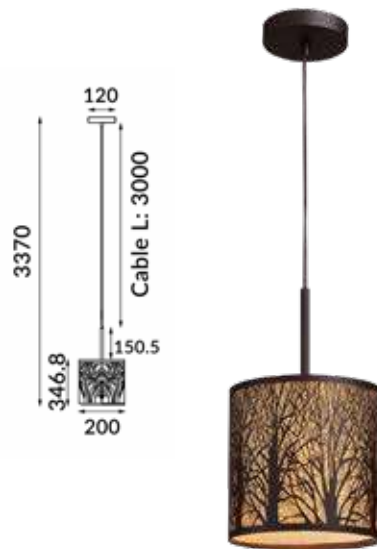

AUTUMN01



Note:
 (1) Adjustable knuckle. Suitable for raked ceiling.
 (2) Can be mounted with the shortest rod only or any combination of short and long rods

AUTUMN02

- Interior drum perforated (trees) aged bronze pendant lights
- Shade: iron with aged bronze finish & PC
- Globe not included
- For indoor use only



Part No.	AUTUMN01
Description	PENDANT SML RND Aged Bronze with Amber Lining w/Amber Int +RND Aged Brz Canopy
Material	Iron & PC
Lamp Holder	1xE27 (Max.60W)
Dimensions	Ø220 x H337mm
Suspension	3000mm cable + 150.5mm rod
Canopy Size	Ø120mm
Carton QTY	1/1

Part No.	AUTUMN02
Description	PENDANT LGE RND Aged Bronze with Amber Lining FR Glass Diffuser w/Amber Int + Rod + RND Aged Brz Canopy
Material	Iron, PC & glass
Lamp Holder	3xE27 (Max.60W)
Dimensions	Ø400 x H200mm
Suspension	500mm cable + 155+305+305+305mm rods
Canopy Size	Ø120mm
Carton QTY	1/1

*AUTUMN interior wall light and table lamp are also available



NORDIC Interior Pendant Lights





- Interior angled dome pendant lights
- Shade: iron & wood
- Shade interior colour: white
- Globe not included
- For indoor use only



Part No.	NORDIC1-6
Description	PENDANT Angled Dome with Blonde Wood + RND Canopy
Material	Powder coated steel & wood
Lamp Holder	1xE27 (Max.60W)
Dimensions	NORDIC1-2: Ø270 x H345mm NORDIC3-4: Ø400 x H395mm NORDIC5-6: Ø560 x H465mm
Suspension	NORDIC1, 3 & 5: 3000mm white and black strips textile cable NORDIC2, 4 & 6: 3000mm textile cable
Canopy Size	Ø100x25mm
Carton QTY	1/1



NORDIC1
(White)

NORDIC2
(Black)



NORDIC3
(White)

NORDIC4
(Black)



NORDIC5
(White)

NORDIC6
(Black)

TAMBURA Interior Pendant Lights



- Interior cylinder cloth shade pendant lights
- Shade: cloth
- Shade interior colour: white
- Globe not included
- For indoor use only



Part No.	TAMBURA01-06
Description	PENDANT Cylinder Cloth Shade with Blonde Wood Trim + RND Canopy
Material	Cloth
Lamp Holder	1xE27 (Max.72W)
Dimensions	TAMBURA01-02: Ø150 x H250mm TAMBURA03-04: Ø300 x H200mm TAMBURA05-06: Ø400 x H250mm
Suspension	3000mm PVC cable
Canopy Size	Ø100x25mm
Carton QTY	1/1

*Product images have a warm white light source 'ON'. TAMBURA table lamps and floor lamps are also available



SWING Interior Pendant Lights



- Interior iron with wood frame pendant lights
- Shade: powder coated iron and wood
- Globe not included
- For indoor use only



Part No.	SWING1-6
Description	PENDANT Iron Oblong/ Dome/ Ellipse + Wood Frame
Material	Iron & wood
Lamp Holder	1xE27 (Max.72W)
Dimensions	SWING1-2: W230 x H320mm SWING3-4: W370 x H215mm SWING5-6: W230 x H320mm
Suspension	3000mm PVC cable
Canopy Size	Ø110x20mm
Carton QTY	1/1

*Product images have a warm white light source 'ON'.



SWING1
(Ellipse Matte white fitting & white interior)

SWING2
(Ellipse Matte black fitting & black interior)

SWING3
(Dome Matte white fitting & white interior)

SWING4
(Dome Matte black fitting & black interior)

SWING5
(Ellipse Matte white fitting & white interior)

SWING6
(Ellipse Matte black fitting & black interior)

HORTEN Interior Pendant Lights



HORTEN1
(Matte white fitting and white interior)



HORTEN2
(Matte black fitting and black interior)

- Interior ellipse pendant lights
- Shade: powder coated iron
- Globe not included
- For indoor use only



Part No.	HORTEN1-2
Description	PENDANT Iron Ellipse with Blonde Wood + RND Canopy
Material	Powder coated iron
Lamp Holder	1xE27 (Max.72W)
Dimensions	Ø150 x H350mm
Suspension	3000mm cable
Canopy Size	Ø110mm
Carton QTY	1/10

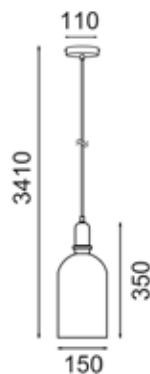



- Interior cone blonde wood opal glass pendant lights
- Shade: blonde wood & opal glass
- Globe not included
- For indoor use only



Part No.	FINN1-3
Description	PENDANT Cone (Flat top) with Blonde Wood + RND Blonde Wood Canopy
Material	Wood & opal glass
Lamp Holder	1xE27 (Max.40W)
Dimensions	FINN1: Ø130 x H320mm FINN2: Ø265 x H185mm FINN3: Ø195 x H245mm
Suspension	3000mm black fabric wire cable
Canopy Size	Ø110x25mm
Carton QTY	FINN1: 1/4 FINN2: 1/2 FINN3: 1/4

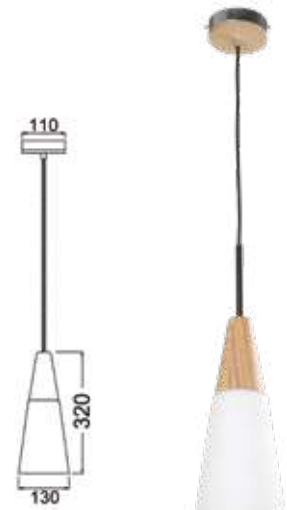

FINN1
(Long Cone)

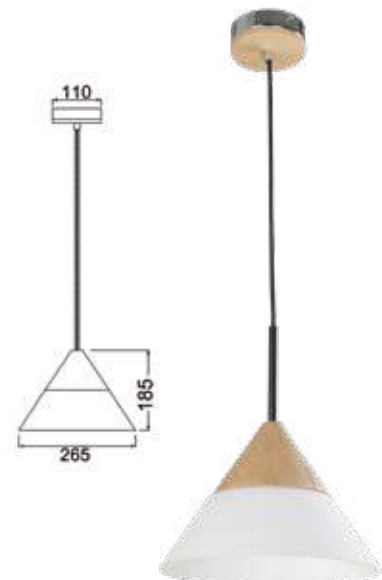

FINN2
(Small Cone)



FINN3
(Medium Cone)

LANTERNA Interior Pendant Lights



LANTERNA1
(Matte black)



LANTERNA2
(Matte white)

- Interior cone(square) iron wood pendant lights
- Shade: powder coated iron & wood
- Globe not included
- For indoor use only



Part No.	LANTERNA1-2
Description	PENDANT Cone (Square) with Blonde Wood + SQ Canopy
Material	Iron & wood
Lamp Holder	1xE27 (Max.72W)
Dimensions	W170xH285mm
Suspension	3000mm PVC cable
Canopy Size	100x100x25mm
Carton QTY	1/10

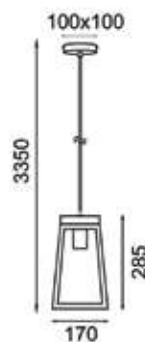

DECOR LIGHTING

FARO Interior Pendant Lights



FARO1
(Matte black)



FARO2
(Matte white)

- Interior cone(convex) iron & wood pendant lights
- Shade: powder coated iron & wood
- Globe not included
- For indoor use only



Part No.	FARO1-2
Description	PENDANT Iron Cone (Concave) with Blonde Wood + RND Canopy
Material	Iron & wood
Lamp Holder	1xE27 (Max.72W)
Dimensions	Ø180xH330mm
Suspension	3000mm PVC cable
Canopy Size	Ø100x25mm
Carton QTY	1/10

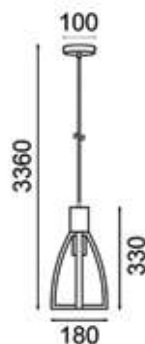

LIGNA Interior Pendant Lights





- Interior wood like pendant lights
- Shade: powder coated aluminium
- Shade interior colour: white
- Globe not included
- For indoor use only



Part No.	LIGNA01-09
Description	PENDANT ES 72W Ellipse/ Margarita Glass / Dome Painted + RND BLK Canopy
Material	Aluminium
Lamp Holder	1xE27 (Max.72W)
Dimensions	LIGNA01-03: Ø250xH280mm LIGNA04-06: Ø400xH320mm LIGNA07-09: Ø400xH190mm
Suspension	3000mm PVC cable
Canopy Size	Ø100x25mm
Carton QTY	1/1

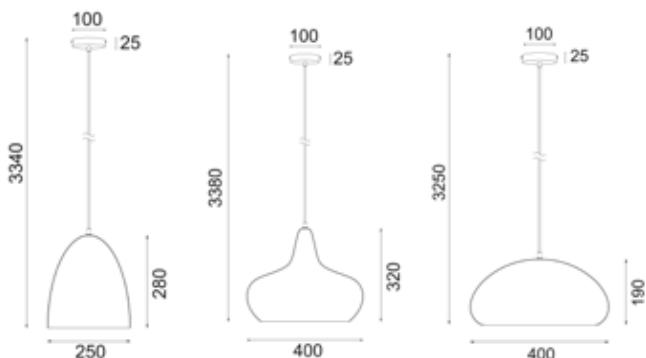

LIGNA01
(Painted Cherry
Cinnamon)



LIGNA02
(Painted Cherry
Golden Oak)



LIGNA03
(Painted Black
Walnut)



LIGNA04
(Painted Cherry
Cinnamon)



LIGNA05
(Painted Cherry
Golden Oak)



LIGNA06
(Painted Black
Walnut)



LIGNA07
(Painted Cherry
Cinnamon)



LIGNA08
(Painted Cherry
Golden Oak)

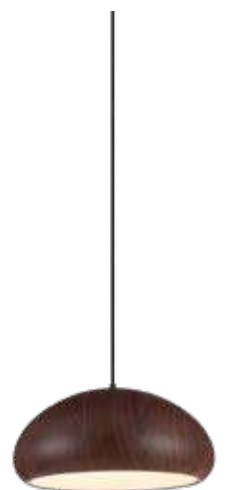

LIGNA09
(Painted Black
Walnut)

ZARA Interior Pendant Lights



ZARA1A
(Painted Oak wood)



ZARA2A
(Painted Burl wood)



ZARA3A
(Satin nickel)



ZARA4A
(Black)



ZARA5A
(White)



- Interior bell/ dome pendant lights
- Shade: powder coated steel
- Shade interior colour: white
- Globe not included
- For indoor use only



Part No.	ZARA1A-5A
Description	PENDANT Bell + S/Circular Nickel Canopy
Material	Steel
Lamp Holder	1xE27 (Max.60W)
Dimensions	Ø160xH345mm
Suspension	3000mm cable
Canopy Size	Ø125x45mm
Carton QTY	1/1

DECOR LIGHTING



ZARA6A
(Painted Oak wood)



ZARA7A
(Painted Burl wood)



ZARA8A
(Satin nickel)



ZARA9A
(Black)

Part No.	ZARA6A-10A
Description	PENDANT Dome + S/Circular Nickel Canopy
Material	Steel
Lamp Holder	1xE27 (Max.60W)
Dimensions	Ø420xH370mm
Suspension	3000mm cable
Canopy Size	Ø125x45mm
Carton QTY	1/1



ZARA10A
(White)

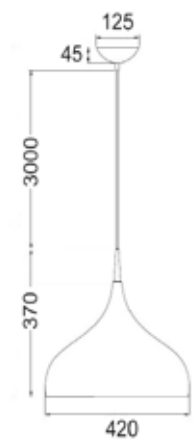

ARMIS Interior Pendant Lights





- Interior iron with tiles pendant lights
- Shade: iron
- Globe not included
- For indoor use only



Part No.	ARMIS1-9
Description	PENDANT Iron with Tiles Wine glass/ Ellipse/ Dome
Material	Iron
Lamp Holder	1xE27 (Max.72W)
Dimensions	ARMIS1-3: Ø300xH270mm ARMIS4-6: Ø250xH255mm ARMIS7-9: Ø400xH200mm
Suspension	3000mm PVC cable
Canopy Size	ARMIS1-3: Ø110x25mm ARMIS4-6: Ø100x25mm ARMIS7-9: Ø110x25mm
Carton QTY	1/1

*Product images have a warm white light source 'ON'.

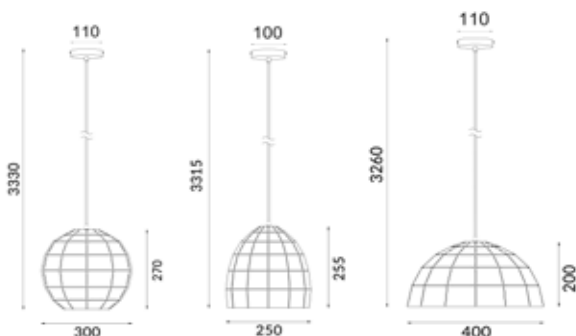

ARMIS1
(Matte white)



ARMIS2
(Champagne Gold)



ARMIS3
(Coffee)



ARMIS4
(Matte white)

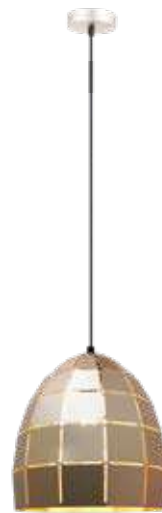

ARMIS5
(Champagne Gold)



ARMIS6
(Coffee)



ARMIS7
(Matte white)



ARMIS8
(Champagne Gold)



ARMIS9
(Coffee)

LEGNA Interior Pendant Lights



- Interior ellipse / dome pendant lights
- Shade: aluminium
- Shade interior colour: white
- Globe not included
- For indoor use only



Part No.	LEGNA1-4
Description	PENDANT Ellipse/ Dome w/Grey + RND Grey Canopy
Material	Aluminium
Lamp Holder	1xE27 (Max.72W)
Dimensions	LEGNA1&3: Ø225xH260mm LEGNA2&4: Ø305xH155mm
Suspension	3000mm PVC cable
Canopy Size	Ø100x25mm
Carton QTY	1/1

*Product images have a warm white light source 'ON'.



LEGNA1
(Painted Natural Oak)



LEGNA3
(Painted Salem Oak)

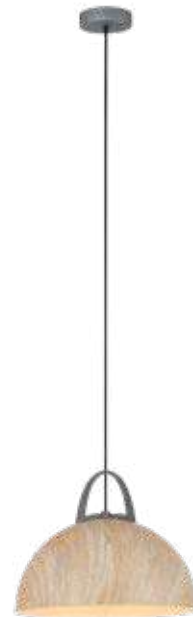

LEGNA2
(Painted Natural Oak)

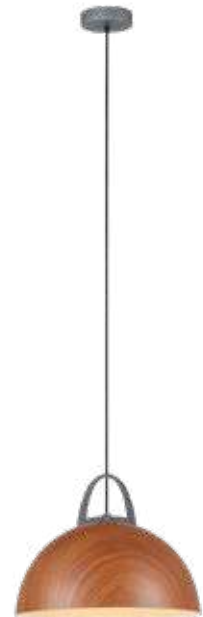

LEGNA4
(Painted Salem Oak)

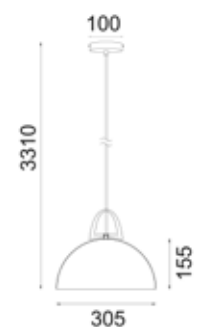

CELESTE Interior Pendant Lights



- Interior black speckled with gold interior pendant lights
- Shade: powder coated aluminium
- Shade interior colour: gold
- Globe not included
- For indoor use only



Part No.	CELESTE1-3
Description	PENDANT ES 40W Bell/ Dome/ Ellipse Black Speckled with Gold Interior + RND BLK Canopy
Material	Powder coated aluminium
Lamp Holder	1xE27 (Max.40W)
Dimensions	CELESTE1: Ø200xH310mm CELESTE2: Ø350xH280mm CELESTE3: Ø305xH305mm
Suspension	3000mm PVC cable
Canopy Size	Ø100mm
Carton QTY	1/1



CELESTE1
(Bell shape)



CELESTE2
(Dome shape)



CELESTE3
(Ellipse shape)

KOPER Interior Pendant Lights

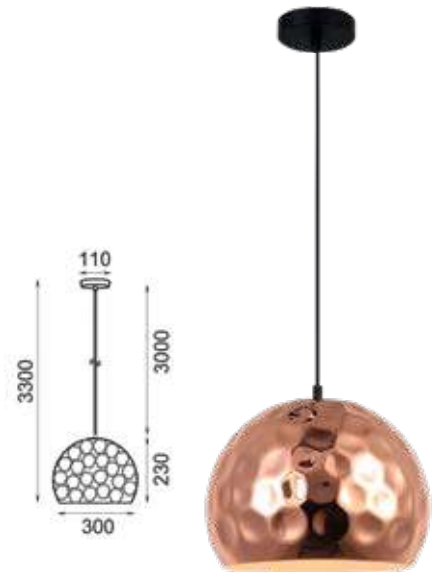

KOPER1
(Wine glass shape)

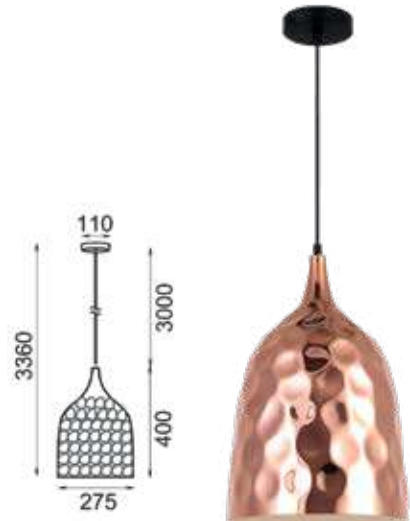

KOPER2
(Ellipse shape)



KOPER3
(Dome shape)

- Interior copper plated iron pendant lights
- Shade: copper plated iron
- Shade interior colour: white
- Globe not included
- For indoor use only



Part No.	KOPER1-3
Description	PENDANT ES 72W Copper Plated Dimpled with White Interior Wine Glass/ Ellipse/ Dome + RND BLK Canopy
Material	Iron
Lamp Holder	1xE27 (Max.72W)
Dimensions	KOPER1: Ø300xH230mm KOPER2: Ø275xH400mm KOPER3: Ø330xH250mm
Suspension	3000mm PVC cable
Canopy Size	Ø110X25mm
Carton QTY	1/1

MODELLO Interior Pendant Lights



MODELLO1
(White)



MODELLO2
(Black)

- Interior cylinder perforated (horseshoes) pendant lights
- Shade: powder coated iron
- Globe not included
- For indoor use only



Part No.	MODELLO1-2
Description	PENDANT Cylinder Perforated (Horseshoes) + RND Canopy
Material	Powder coated iron
Lamp Holder	1xE27 (Max.72W)
Dimensions	Ø130xH250mm
Suspension	3000mm cable
Canopy Size	Ø100mm
Carton QTY	1/1

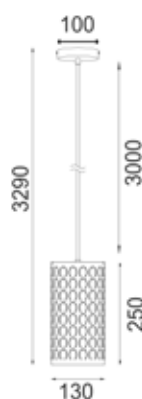

*Product images have a warm white light source 'ON'.

GLAZE Interior Pendant Lights



GLAZE1
(Red)



GLAZE2
(Green)



GLAZE3
(Blue)



GLAZE5
(Amber)

- Interior ellipse glass(Blown) feathered pendant lights
- Shade: satin nickel hardware with glass
- Globe not included
- For indoor use only

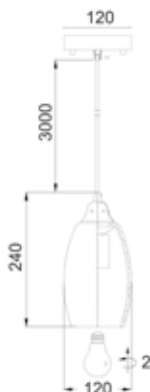

Part No.	GLAZE1-3 & GLAZE5
Description	PENDANT Ellipse Glass (Blown) Feathered + RND S/C Canopy
Material	Glass & iron
Lamp Holder	1xE27 (Max.60W)
Dimensions	Ø120xH240mm
Suspension	3000mm clear flex
Canopy Size	Ø120mm
Carton QTY	1/1

*Product images have a warm white light source 'ON'.



GLAZE10
(Dark & Light
with Dark Infill)



GLAZE11
(Dark & Light
with light Infill)

- Interior stone mosaic glass pendant lights
- Shade: glass, stone & iron
- Globe not included
- For indoor use only



Part No.	GLAZE10-11
Description	PENDANT ES 60W Stone Mosaic Ellipse (Hand Blown Glass)
Material	Glass, stone & iron
Lamp Holder	1xE27 (Max.60W)
Dimensions	Ø136xH252mm
Suspension	3000mm cable
Canopy Size	Ø120x25mm
Carton QTY	1/1

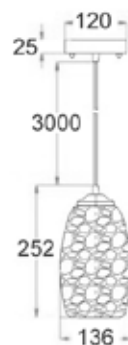

*Product images have a warm white light source 'ON'.

RICTUS Interior Pendant Lights

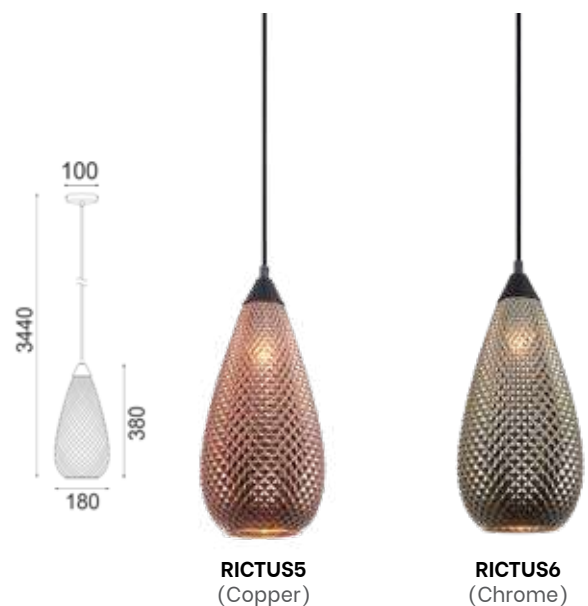
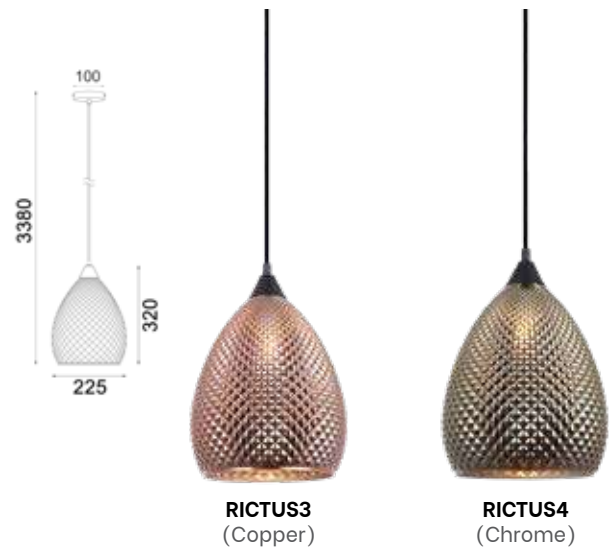
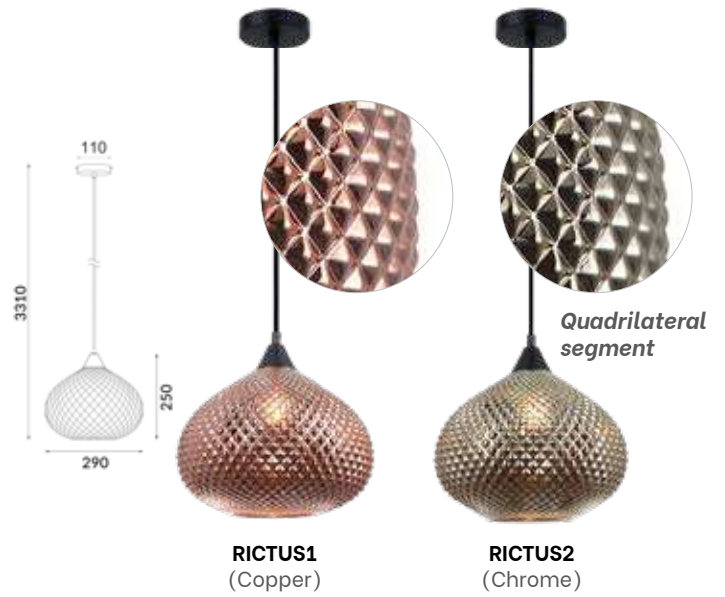

- Interior peaked copper / chrome painted pendant lights
- Shade: glass
- Globe not included
- For indoor use only



Part No.	RICTUS1-6
Description	PENDANT Wine Glass/ Ellipse/ Tear Drop Peaked Copper/Chrome Painted Glass +RND BLK Canopy
Material	Glass
Lamp Holder	1xE27 (Max.72W)
Dimensions	RICTUS1-2: Ø290xH250mm RICTUS3-4: Ø225xH320mm RICTUS5-6: Ø180xH380mm
Suspension	3000mm cable
Canopy Size	RICTUS1-2: Ø110X25mm RICTUS3-6: Ø100X25mm
Carton QTY	1/1

*Product images have a warm white light source 'ON'.

ORDITO Interior Pendant Lights



ORDITO1
(Champagne glass)



ORDITO2
(Black chrome glass)



ORDITO3
(Gold plated glass)

- Interior glass dimpled ellipse pendant lights
- Shade: chrome metal with glass
- Globe not included
- For indoor use only



Part No.	ORDITO1-3
Description	PENDANT ES 60W Glass Ellipse with Chrome Highlight + RND CH Canopy
Material	Glass, chrome metal
Lamp Holder	1xE27 (Max.60W)
Dimensions	Ø146xH232mm
Suspension	3000mm clear flex
Canopy Size	Ø120x25mm
Carton QTY	1/1

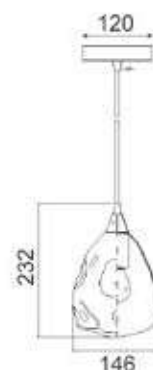

*Product images have a warm white light source 'ON'.

MASON Interior Pendant Lights



- Interior glass pendant lights
- Shade: glass & iron
- Globe not included
- For indoor use only



Part No.	MASON1-9
Description	PENDANT Glass Cylinder/ Cylinder Tipped/ Oval with Black Highlight + RND BLK Canopy
Material	Glass & iron
Lamp Holder	1xE27 (Max.60W)
Dimensions	MASON1-3: Ø180xH360mm MASON4-6: Ø180xH310mm MASON7-9: Ø280xH200mm
Suspension	3000mm cable
Canopy Size	Ø100x40mm
Carton QTY	1/4

CHUVA Interior Pendant Lights



CHUVA1
(Flat top ellipse shape)

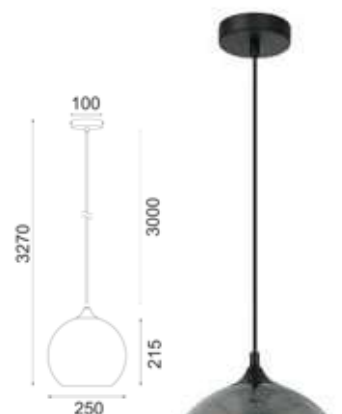

CHUVA2
(Wine glass shape)



CHUVA3
(Ellipse shape)

- Interior glass rain drop effect pendant lights
- Shade: glass & iron
- Globe not included
- For indoor use only



Part No.	CHUVA1-3
Description	PENDANT Smokey BLK Glass with Rain Drop Effect + RND BLK Canopy
Material	Glass & iron
Lamp Holder	1xE27 (Max.72W)
Dimensions	CHUVA1: Ø135xH350mm CHUVA2: Ø250xH215mm CHUVA3: Ø250xH265mm
Suspension	3000mm cable
Canopy Size	Ø100mm
Carton QTY	CHUVA1: 1/10 CHUVA2-3: 1/1



Rain drop effect

*Product images have a warm white light source 'ON'.

BARROSA, PENOLA, RIVERINA & YARRA Interior Pendant Lights





BARROSA
(Margarita Glass shape)



PENOLA
(Martini Glass shape)



RIVERINA
(Martini Glass shape)



YARRA
(Flute shape)

- Interior smokey black glass pendant lights
- Shade: glass
- Globe not included
- For indoor use only



Part No.	BARROSA, PENOLA, RIVERINA & YARRA
Description	PENDANT Smokey Black Glass + RND BLK Canopy
Material	Glass
Lamp Holder	1xGU10 (Max. 50W)
Dimensions	BARROSA: Ø200xH230mm PENOLA: Ø165xH260mm RIVERINA: Ø240xH205mm YARRA: Ø90xH200mm
Suspension	3000mm cable
Canopy Size	Ø100mm
Carton QTY	1/10

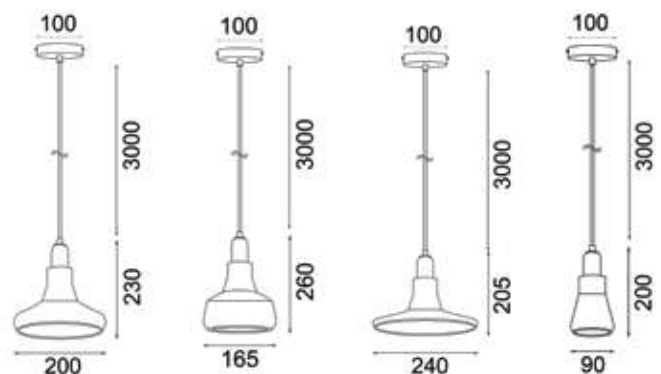

CASA Interior Pendant Lights

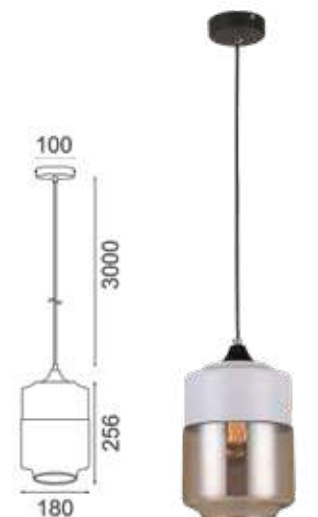

CASA1
(Cylinder shape)

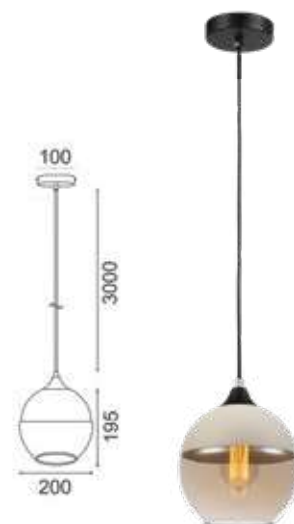

CASA2
(Wine glass shape)



CASA3
(Cylinder shape)

- Interior Amber and matte white painted glass pendant lights
- Shade: amber glass (partially paint dipped)
- Globe not included
- For indoor use only



Part No.	CASA1-3
Description	PENDANT Amber & Matte White Painted Glass + RND BLK Canopy
Material	Glass
Lamp Holder	1xE27 (Max.72W)
Dimensions	CASA1: Ø180xH256mm CASA2: Ø200xH195mm CASA3: Ø130xH285mm
Suspension	3000mm cable
Canopy Size	Ø100mm
Carton QTY	1/1

*Product images have a warm white light source 'ON'.

FUMOSO Interior Pendant Lights



- Interior smokey glass with copper painting pendant lights
- Shade: iron & glass
- Globe not included
- For indoor use only



Part No.	FUMOSO1-3
Description	PENDANT Smokey Glass with Copper Painting Cone/ Ellipse/ Dome Shape + RND BLK Canopy
Material	Iron & glass
Lamp Holder	1xE27 (Max.72W)
Dimensions	FUMOSO1: Ø180xH280mm FUMOSO2: Ø145xH300mm FUMOSO3: Ø250xH270mm
Suspension	3000mm cable
Canopy Size	Ø100mm
Carton QTY	1/1

*Product images have a warm white light source 'ON'.

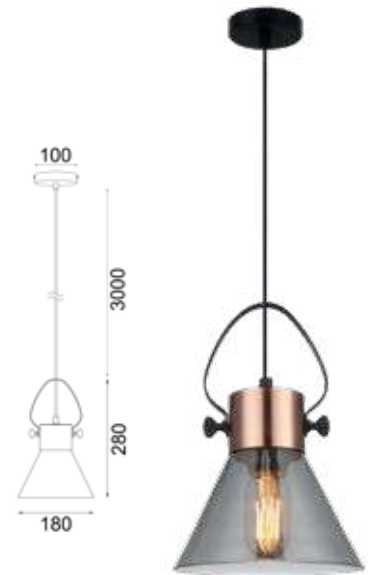

FUMOSO1
(Cone shape)

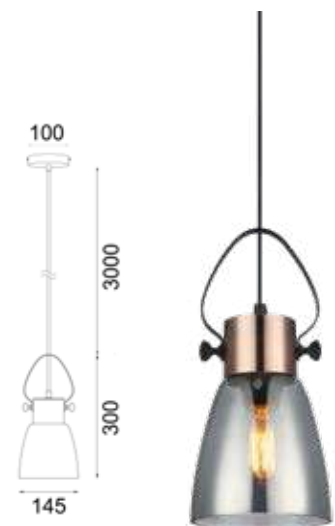

FUMOSO2
(Ellipse shape)



FUMOSO3
(Dome shape)



- Interior copper painted glass pendant lights
- Shade: glass
- Globe not included
- For indoor use only



Part No.	LAMINA1, LAMINA3, LAMINA4
Description	PENDANT ES 72W Copper Coloured Glass + RND BLK Canopy
Material	Glass
Lamp Holder	1xE27 (Max.72W)
Dimensions	LAMINA1: Ø135xH350mm LAMINA3: Ø170xH280mm LAMINA4: Ø280xH170mm
Suspension	3000mm black cable
Canopy Size	Ø100 x 25mm
Carton QTY	1/1

*Product images have a warm white light source 'ON'.



LAMINA1
(Ellipse shape)



LAMINA3
(Double Cylinder shape)

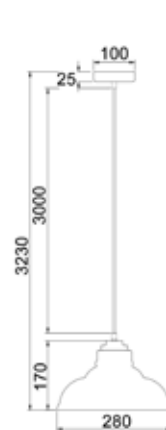

LAMINA4
(Dome / Chrome interior)

TONO Interior Pendant Lights



TONO1
(Glass with Black Mesh)



TONO2
(Clear Glass with Copper Mesh)



TONO3
(Clear Glass with Brass Mesh)

- Interior cylinder clear glass with mesh pendant lights
- Shade: glass
- Globe not included
- For indoor use only



Part No.	TONO1-3
Description	PENDANT Mesh Internal Cylinder (Dbl) Glass with Mesh + RND Canopy
Material	Powder coated iron & clear glass
Lamp Holder	1xE27 (Max.40W)
Dimensions	Ø200xH280mm
Suspension	3000mm cable
Canopy Size	Ø100mm
Carton QTY	1/4

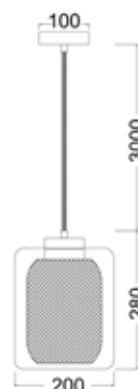

GAMBA Interior Pendant Lights



- Interior angular cage pendant lights
- Shade: antique brass & oiled bronze/ white & polished nickel
- Globe not included
- For indoor use only



Part No.	GAMBA1 & GAMBA3
Description	PENDANT ES x 5 60W Wide Antique Cage + RND Stepped Canopy
Material	Antique brass & oiled bronze / White & polished nickel
Lamp Holder	5xE27 (Max.60W)
Dimensions	Ø600xH451mm
Suspension	3000mm chain & cable
Canopy Size	Ø135mm
Carton QTY	1/1



GAMBA1
(Antique brass & oiled bronze)



GAMBA3
(White & polished nickel)

Part No.	GAMBA2 & GAMBA4
Description	PENDANT ES x 4 60W Narrow Antique Cage + RND Stepped Canopy
Material	Antique brass & oiled bronze / White & polished nickel
Lamp Holder	4xE27 (Max.60W)
Dimensions	Ø380xH750mm
Suspension	3000mm chain & cable
Canopy Size	Ø135mm
Carton QTY	1/1



GAMBA2
(Antique brass & oiled bronze)



GAMBA4
(White & polished nickel)

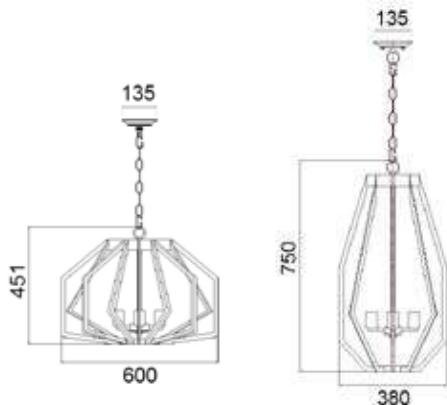

SPIAGGIA Interior Pendant Lights



SPIAGGIA1
(Dome/ Black)



SPIAGGIA2
(Dome/ White)



SPIAGGIA3
(Cone/ Black)



SPIAGGIA4
(Cone/ White)

- Interior wavy edge iron pendant lights
- Shade: powder coated iron & wood
- Globe not included
- For indoor use only



Part No.	SPIAGGIA1-4
Description	PENDANT ES 72W Iron Dome /Cone(Wavy Edge) w/Blonde Wood + RND Canopy
Material	Iron & wood
Lamp Holder	1xE27 (Max.72W)
Dimensions	SPIAGGIA1-2: Ø400xH250mm SPIAGGIA3-4: Ø330xH400mm
Suspension	3000mm cable
Canopy Size	Ø110x25mm
Carton QTY	1/1

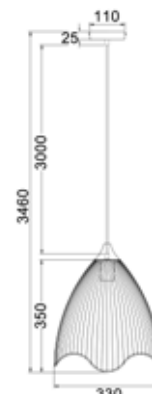
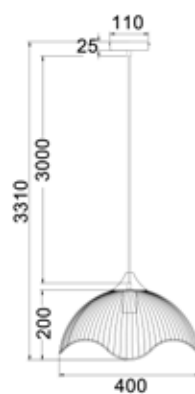

DECOR LIGHTING

STRAND Interior Pendant Lights



STRAND1
(Black)



STRAND2
(White)

- Interior dome wire with Blonde Wood pendant lights
- Shade: powder coated iron & wood
- Globe not included
- For indoor use only



Part No.	STRAND1-2
Description	PENDANT ES 72W Iron Dome Wire with Blonde Wood +RND Canopy
Material	Iron & wood
Lamp Holder	1xE27 (Max.72W)
Dimensions	Ø400xH295mm
Suspension	3000mm cable
Canopy Size	Ø110x25mm
Carton QTY	1/1



VENETO Interior Pendant Lights



- Interior cylinder black mesh iron pendant lights
- Mesh shade can be removed
- Shade: iron
- Globe not included
- For indoor use only



Part No.	VENETO1BK & VENETO1X3BK
Description	PENDANT ES 72W Cylinder BLK Mesh Iron + RND BLK Canopy
Material	Iron
Lamp Holder	VENETO1BK: 1xE27 (Max.72W) VENETO1X3BK: 3xE27 (Max.72W)
Dimensions	VENETO1BK: Ø120xH230mm VENETO1X3BK: Ø320mm
Suspension	VENETO1BK: 3000mm cable VENETO1X3BK: 2.6m/ 2.8m/ 3m cable
Canopy Size	VENETO1BK: Ø100mm VENETO1X3BK: Ø300mm
Carton QTY	VENETO1BK: 1/10 VENETO1X3BK: 1/1

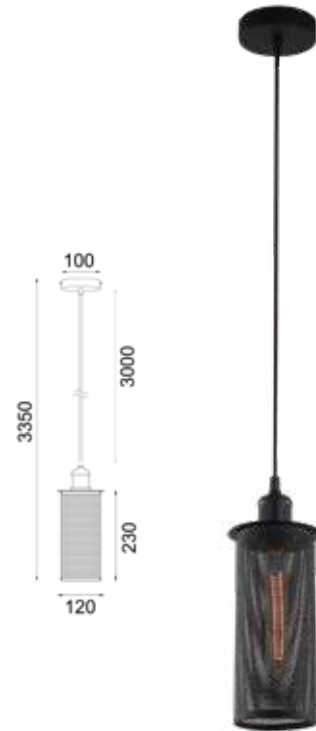

VENETO1BK

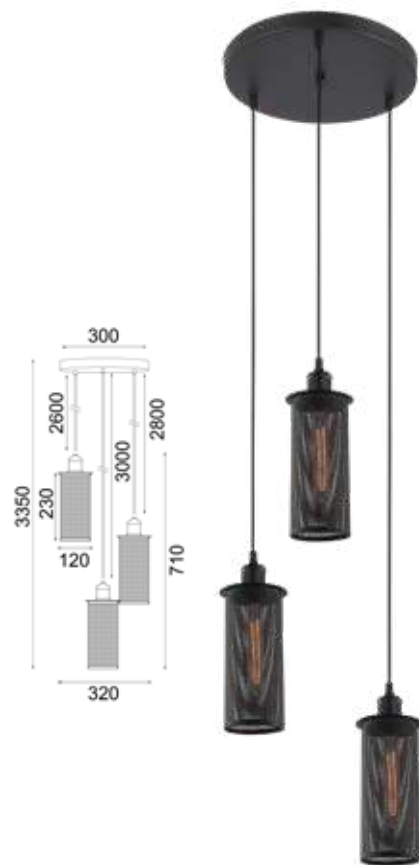

VENETO1X3BK

*VENETO table lamps and interior wall lights are also available



CHEVEUX Interior Pendant Lights



CHEVEUX1
(Ellipse)



CHEVEUX2
(Small wine glass shape)



CHEVEUX3
(Bell shape)



CHEVEUX4
(Large wine glass shape)

- Interior black mesh iron pendant lights
- Shade: powder coated iron
- Globe not included
- For indoor use only



Part No.	CHEVEUX1-4
Description	PENDANT ES 72W BLK Mesh Iron + RND BLK Canopy
Material	Iron
Lamp Holder	1xE27 (Max.72W)
Dimensions	CHEVEUX1: Ø170xH230mm CHEVEUX2: Ø190xH225mm CHEVEUX3: Ø330xH370mm CHEVEUX4: Ø280xH295mm
Suspension	3000mm cable
Canopy Size	Ø100mm
Carton QTY	CHEVEUX1: 1/10 CHEVEUX2-4: 1/1

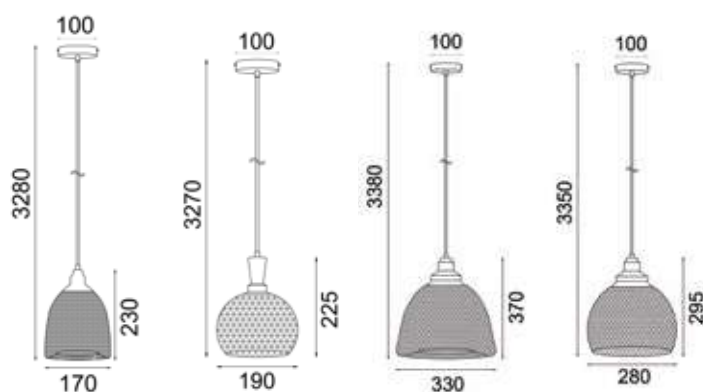

SENTINEL Interior Pendant Lights

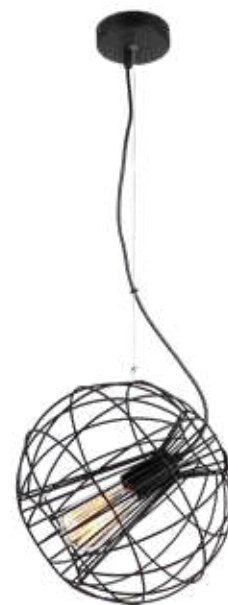

SENTINEL1
(Matte black)



SENTINEL2
(Matte white)

- Interior sphere wire iron with adjustable hanging angle pendant lights
- Shade: iron
- Globe not included
- For indoor use only



Part No.	SENTINEL1-2
Description	PENDANT ES 72W Sphere Wire with Adjustable Hanging Angle + RND M/BLK Canopy
Material	Iron
Lamp Holder	1xE27 (Max.72W)
Dimensions	Ø300xH255mm
Suspension	3000mm cable
Canopy Size	Ø110x25mm
Carton QTY	1/1

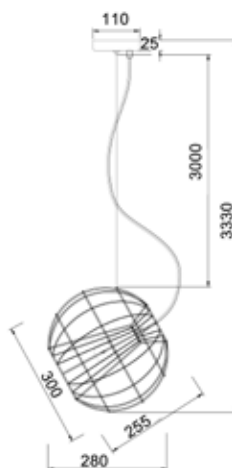

MATRIX Interior Pendant Lights

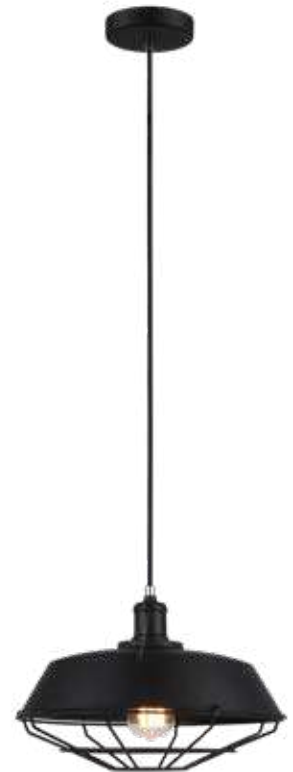

MATRIX-B
(Black)

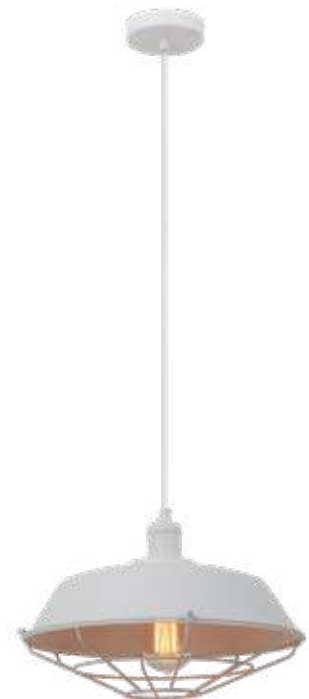

MATRIX-W
(White)

- Interior iron dome (angled) cage pendant lights
- Shade: powder coated iron
- Globe not included
- For indoor use only



Part No.	MATRIX-B, MATRIX-W
Description	PENDANT ES 72W Dome (Angled) Cage + RND Canopy
Material	Iron
Lamp Holder	1xE27 (Max.72W)
Dimensions	Ø360xH230mm
Suspension	3000mm cable
Canopy Size	Ø110mm
Carton QTY	1/1

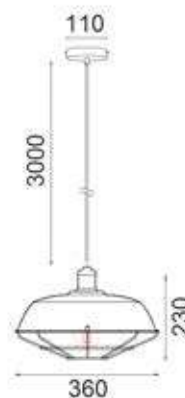

BLACKBAND Interior Pendant Lights



BLACKBAND1
(Cylinder Wire Cage)



BLACKBAND2
(Bell Wire Cage)



BLACKBAND3
(Cylinder Wire Cage)



BLACKBAND4
(Pear Wire Cage)

- Interior iron wire cage pendant lights
- Shade: powder coated iron
- Globe not included
- For indoor use only



Part No.	BLACKBAND1-4
Description	PENDANT ES 72W BLK Iron Wire Cage + RND BLK Canopy
Material	Iron
Lamp Holder	1xE27 (Max.72W)
Dimensions	BLACKBAND1: Ø117xH270mm BLACKBAND2: Ø150xH225mm BLACKBAND3: Ø80xH260mm BLACKBAND4: Ø110xH210mm
Suspension	3000mm cable
Canopy Size	Ø100mm
Carton QTY	1/1

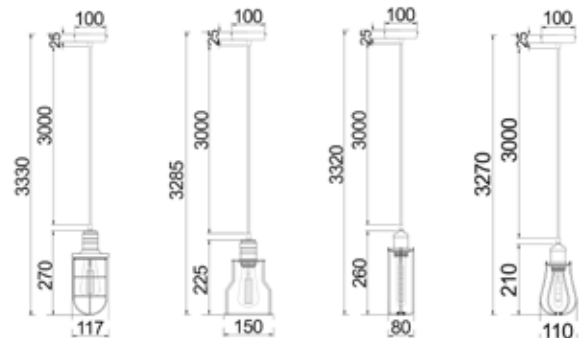

GLOBE RESTRICTIONS (Max.globe dimensions):

BLACKBAND1: L135 x W60mm; BLACKBAND2: L N/A x W60mm; BLACKBAND3: L180 x W30mm; BLACKBAND4: L130 x W30mm

BLACKBAND & WHITEBAND

Interior Pendant Lights



BLACKBAND5
(Diamond Wire Cage)



BLACKBAND6
(Diamond Wire Cage)



WHITEBAND5
(Diamond Wire Cage)



WHITEBAND6
(Diamond Wire Cage)

Part No.	BLACKBAND5 & WHITEBAND5
Description	PENDANT ES 72W Iron Diamond Wire Cage + RND Canopy
Material	Iron
Lamp Holder	1xE27 (Max.72W)
Dimensions	175xH420mm
Suspension	3000mm cable
Canopy Size	Ø100x25mm
Carton QTY	1/1

Part No.	BLACKBAND6 & WHITEBAND6
Description	PENDANT ES 72W Iron Diamond Wire Cage + RND Canopy
Material	Iron
Lamp Holder	1xE27 (Max.72W)
Dimensions	240(Widest point)xH400mm
Suspension	3000mm cable
Canopy Size	Ø100x25mm
Carton QTY	1/1

GLOBE RESTRICTIONS (Max.globe dimensions):

BLACKBAND5 & WHITEBAND5: L180 x W30mm;

BLACKBAND6 & WHITEBAND6: L180 x W30mm

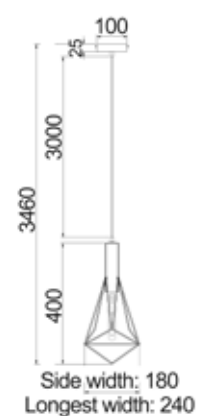
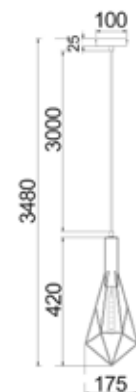



BLACKBAND1X3



BLACKBAND2X3



WHITEBAND1X3



WHITEBAND2X3

Part No.	BLACKBAND1X3 & WHITEBAND1X3
Description	PENDANT ESX3 72W Iron Diamond Wire Cage + Bar Base
Material	Iron
Lamp Holder	3xE27 (Max.72W)
Dimensions	W630xH380mm
Suspension	3000mm cable
Canopy Size	L550xW40xH20mm
Carton QTY	1/1

Part No.	BLACKBAND2X3 & WHITEBAND2X3
Description	PENDANT ESX3 72W Iron Diamond Wire Cage Varied + RND Base
Material	Iron
Lamp Holder	3xE27 (Max.72W)
Dimensions	Ø390xmm
Suspension	3000mm cable
Canopy Size	Ø300x25mm
Carton QTY	1/1

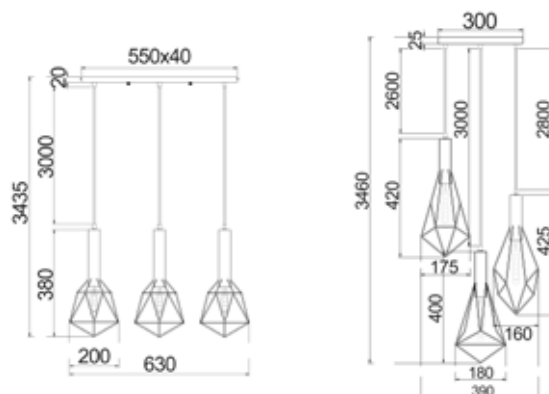

GLOBE RESTRICTIONS (Max.globe dimensions):

BLACKBAND1X3 & WHITEBAND1X3: L130 x W30mm;
 BLACKBAND2X3 & WHITEBAND2X3: L180 x W30mm

PASTEL Interior Pendant Lights





PASTELO1A
(Matte white)

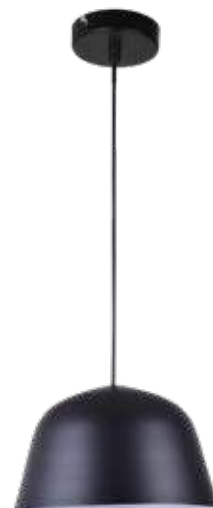

PASTELO2A
(Matte black)



PASTELO3A
(Matte pink)



PASTELO4A
(Matte grey)

- Interior angled dome pendant lights
- Shade: powder coated iron
- Shade interior colour: white
- Globe not included
- For indoor use only

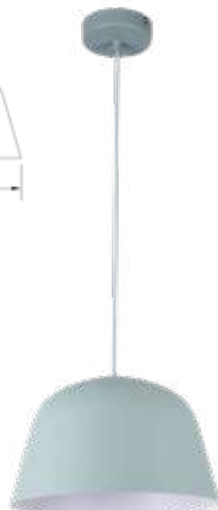
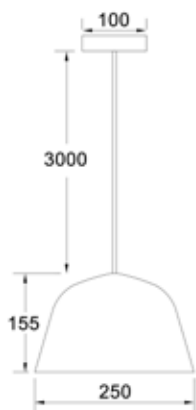

PASTELO5A
(Matte green)



PASTELO6A
(Matte blue)



PASTELO7A
(Matte yellow)

Part No.	PASTELO1A-07A
Description	PENDANT ES 40W Angled Dome + RND Canopy
Material	Iron
Lamp Holder	1xE27 (Max.40W)
Dimensions	Ø250xH155mm
Suspension	3000mm fabric cable
Canopy Size	Ø100mm
Carton QTY	1/1



PASTEL08A
(Matte white)



PASTEL09A
(Matte black)



PASTEL10A
(Matte pink)



PASTEL11A
(Matte grey)

- Interior dome pendant lights
- Shade: powder coated iron
- Shade interior colour: white
- Globe not included
- For indoor use only

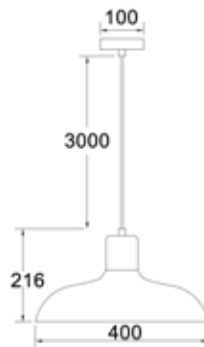

Part No.	PASTEL08A-14A
Description	PENDANT ES 40W Dome with Copper plating + RND Canopy
Material	Iron
Lamp Holder	1xE27 (Max.40W)
Dimensions	Ø400xH216mm
Suspension	3000mm fabric cable
Canopy Size	Ø100mm
Carton QTY	1/1

*PASTEL table lamps & floor lamps are also available



PASTEL12A
(Matte green)



PASTEL13A
(Matte blue)



PASTEL14A
(Matte yellow)

ALTA Interior Pendant Lights



ALTA1
(Matte white)



ALTA2
(Matte black)



ALTA3
(Matte grey)

- Interior bell with copper plating pendant lights
- Shade: powder coated iron
- Globe not included
- For indoor use only



Part No.	ALTA1-3
Description	PENDANT ES 72W Bell with Copper Plating + RND Canopy
Material	Iron
Lamp Holder	1xE27 (Max.72W)
Dimensions	Ø225xH290mm
Suspension	3000mm cable
Canopy Size	Ø110mm
Carton QTY	1/1



*Product images have a warm white light source 'ON'.
*ALTA interior wall lights are also available.

NARVIK Interior Pendant Lights



NARVIK1
(Matte white)



NARVIK2
(Matte black)



NARVIK3
(Matte grey)

- Interior dome with copper plating pendant lights
- Shade: powder coated iron
- Globe not included
- For indoor use only



Part No.	NARVIK1-3
Description	PENDANT ES 72W Dome with Copper Plating + RND Canopy
Material	Iron
Lamp Holder	1xE27 (Max.72W)
Dimensions	Ø360xH280mm
Suspension	3000mm cable
Canopy Size	Ø110mm
Carton QTY	1/5

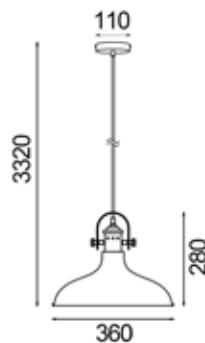

DIVO Interior Pendant Lights



- Interior angled dome pendant lights
- Shade: powder coated steel
- Shade interior colour: white
- Globe not included
- For indoor use only



DIVO1
(Antique brass)



DIVO2
(Chrome)



DIVO3
(Satin chrome)

Part No.	DIVO1-10
Description	PENDANT ES 60W An- gled Dome + RND Canopy
Material	Steel
Lamp Holder	1xE27 (Max.60W)
Dimensions	Ø355xH250mm
Suspension	3000mm cable
Canopy Size	Ø100mm
Carton QTY	1/1



DIVO4
(White)



DIVO5
(Black)



DIVO6
(Blue)



DIVO7
(Red)



DIVO8
(Green)



DIVO9
(Yellow)



DIVO10
(Orange)

DEKSEL Interior Pendant Lights



DEKSEL03

- Interior angled dome aged copper pendant light
- Shade: aged oxidised solid copper
- Globe not included
- For indoor use only



Part No.	DEKSEL03
Description	PENDANT ES 60W Aged Copper (Brass Bracket & Base) + RND Tapered COP Canopy
Material	Copper
Lamp Holder	1xE27 (Max.60W)
Dimensions	Ø400xH175mm
Suspension	1100mm chain & cable
Canopy Size	Ø135x23mm
Carton QTY	1/4

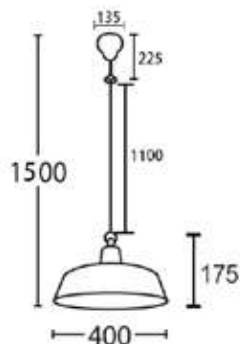

*DEKSEL exterior wall light & interior wall light are also available

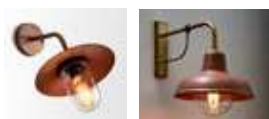

CAVIAR Interior Pendant Lights

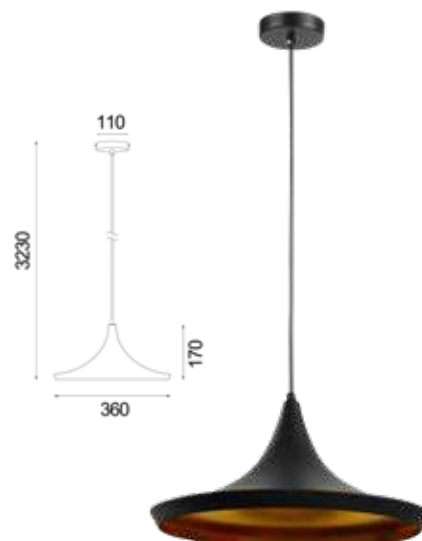

CAVIAR4
(Trumpet shape)

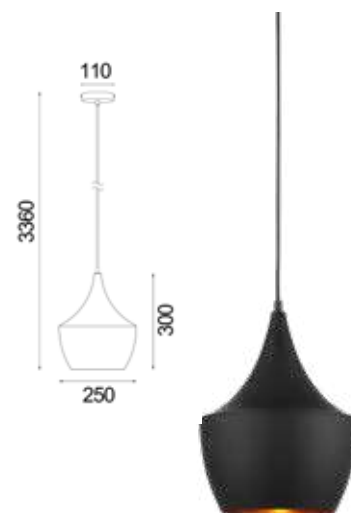

CAVIAR5
(Angled Wine Glass shape)

- Interior pendant lights
- Shade: powder coated aluminium
- Shade internal: dimpled design
- Shade interior colour: gold
- Globe not included
- For indoor use only



Gold Dimpled internal design



Part No.	CAVIAR4-5
Description	PENDANT ES 72W BLK with Gold Dimpled Internal + RND BLK Canopy
Material	Aluminium
Lamp Holder	1xE27 (Max.72W)
Dimensions	CAVIAR4: Ø360xH170mm CAVIAR5: Ø250xH300mm CAVIAR6: Ø190xH400mm
Suspension	3000mm PVC cable
Canopy Size	Ø110mm
Carton QTY	CAVIAR4-5: 1/1 CAVIAR6: 1/10

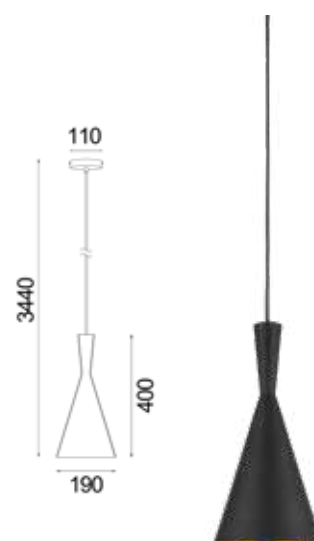

CAVIAR6
(Cone shape)

CLASSIC Interior Pendant Lights



CLASSIC1A
(Red)



CLASSIC2A
(White)

- Interior cone pendant lights
- Shade: powder coated aluminium
- Globe not included
- For indoor use only



Part No.	CLASSIC1A-2A
Description	PENDANT ES 40W Cone w/CH + RND Tapered Red Canopy
Material	Aluminium
Lamp Holder	1xE27 (Max.40W)
Dimensions	Ø160xH300mm
Suspension	3000mm PVC cable
Canopy Size	Ø120mm
Carton QTY	1/1

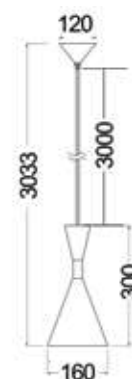

DECOR LIGHTING

PIATTO Interior Pendant Lights

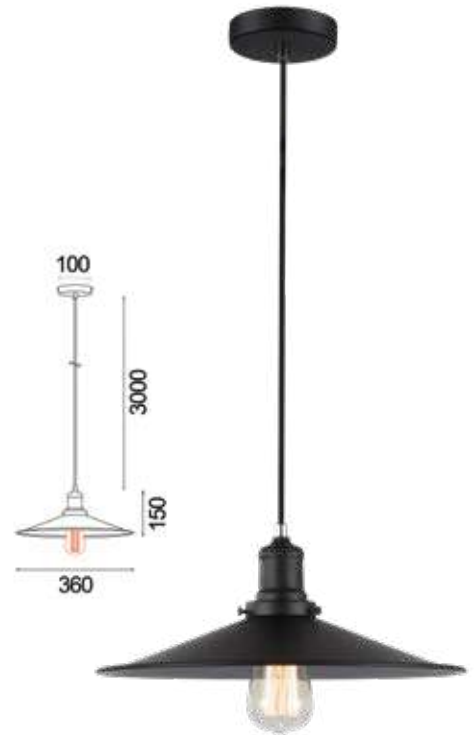

PIATTO1
(Large coolie)

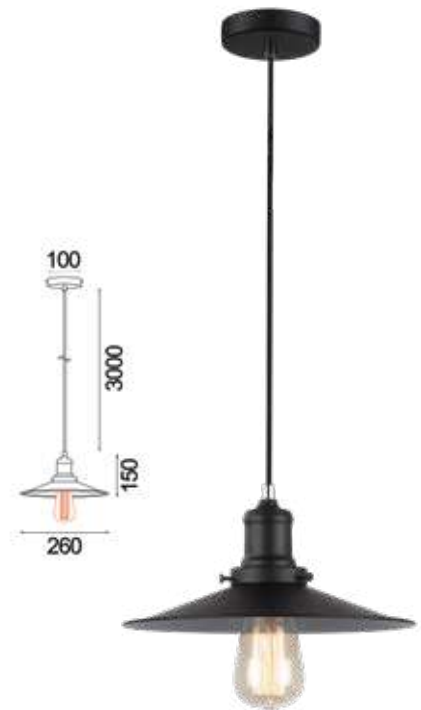

PIATTO2
(Small coolie)

- Interior coolie black pendant lights
- Shade: powder coated iron
- Globe not included
- For indoor use only



Part No.	PIATTO1-2
Description	PENDANT ES 72W BLK Coolie LGE/SML + RND BLK Canopy
Material	Iron
Lamp Holder	1xE27 (Max.72W)
Dimensions	PIATTO1: Ø360xH150mm PIATTO2: Ø260xH150mm
Suspension	3000mm cable
Canopy Size	Ø100mm
Carton QTY	PIATTO1: 1/5 PIATTO2: 1/10

PEN Interior Pendant Lights



PEN2
(White)



PEN3
(Black)

- Interior pendant light suspensions
- Shade: silicone
- Globe not included
- For indoor use only



Part No.	PEN2 & PEN3
Description	PENDANT ES 60W Suspension + RND Tapered Silicon Canopy
Material	Silicone
Lamp Holder	1xE27 (Max.60W)
Dimensions	Ø40xH95mm
Suspension	3000mm cable
Canopy Size	Ø120mm
Carton QTY	1/20

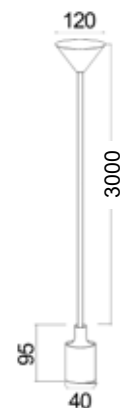

CLUSTER Interior Pendant Lights



CLUSTER1



CLUSTER2

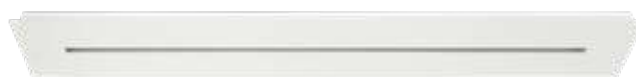

CLUSTER3



CLUSTER4

- Cluster pendant canopies
- Available in 2 designs: Round (Max.6 lights) & Rectangular (Max.11 lights)
- Colour: Matt black / matt white
- Material: iron
- Surface mounted (Mounting bracket included)

IP20
Rated

1 YEAR
Replacement
Warranty

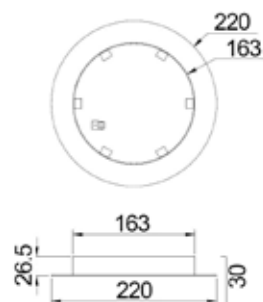
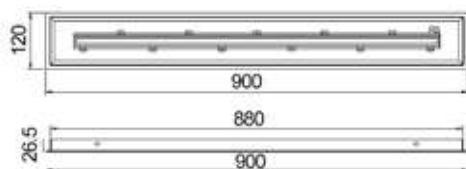

Part No.	Description	Dimensions	Carton QTY
CLUSTER1	RND S/M Cluster Canopy 6 Lights WH	Ø220x26.5mm	1/10
CLUSTER2	RND S/M Cluster Canopy 6 Lights BLK	Ø220x26.5mm	1/10
CLUSTER3	RECT S/M Cluster Canopy 11 Lights WH	900x120x26.5mm	1/10
CLUSTER4	RECT S/M Cluster Canopy 11 Lights BLK	900x120x26.5mm	1/10



**DECORATIVE
CEILING SPOT LIGHTS**

TACHE Ceiling Spot Lights



TACHE1



TACHE2



TACHE3

- Interior spot ceiling lights
- Material: aluminium
- Globe not included
- For indoor use only



Part No.	TACHE1-3
Description	SPOT GU10 Interior Ceiling Lamp Adj Ant/Brs Head w/Brs Rnd Base + Rect BLK Canopy
Material	Aluminium
Lamp holder	TACHE1: 3 x GU10 (Max.35W) TACHE2: 4 x GU10 (Max.35W) TACHE3: 6 x GU10 (Max.35W)
Dimensions	TACHE1: Ø510 x H120mm TACHE2: 520 x 520 x H120mm TACHE3: 720 x 400 x H120mm
Base	TACHE1-2: Ø160mm TACHE3: Ø180mm
Canopy	TACHE1: Ø90 x H45mm TACHE2: Ø90 x H45mm TACHE3: Ø100 x H45mm
Carton QTY	1/1

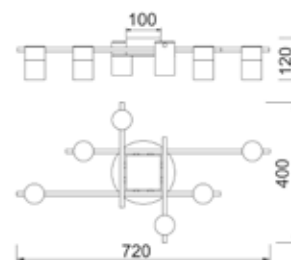
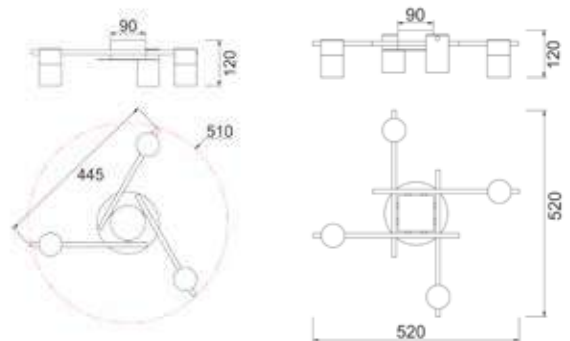

TACHE Ceiling Spot Lights



TACHE4



TACHE5



TACHE6

- Interior spot ceiling lights
- Material: aluminium
- Globe not included
- For indoor use only



Part No.	TACHE4-6
Description	SPOT GU10 Interior Ceiling Lamp Adj Blk & Ant/Brs Head w/Brs Rnd Base + Rect BLK Canopy
Material	Aluminium
Lamp holder	TACHE4: 3 x GU10 (Max.35W) TACHE5: 4 x GU10 (Max.35W) TACHE6: 6 x GU10 (Max.35W)
Dimensions	TACHE4: Ø510 x H120mm TACHE5: 520 x 520 x H120mm TACHE6: 720 x 400 x H120mm
Base	TACHE4-5: Ø160mm TACHE6: Ø180mm
Canopy	TACHE4: Ø90 x H45mm TACHE5: Ø90 x H45mm TACHE6: Ø100 x H45mm
Carton QTY	1/1

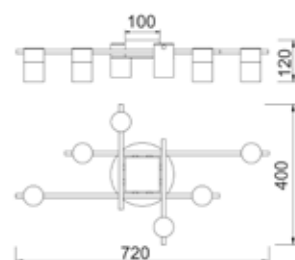
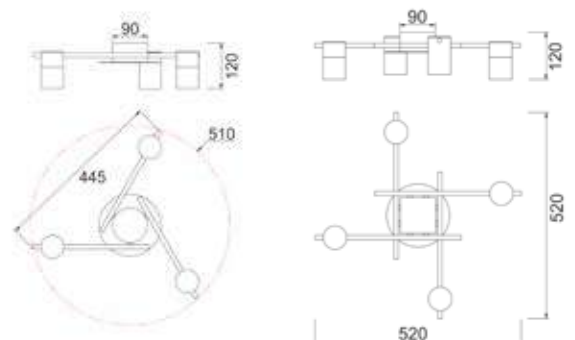



DECORATIVE
TABLE & FLOOR LAMPS

TAMBURA Table & Floor Lamps



TAMBURA07TL
(White)



TAMBURA08TL
(Black)



TAMBURA09TL
(White)



TAMBURA10TL
(Black)

- Interior table & floor lamps
- Material: cloth shade with wood veneer trim
- Base: Power coated iron
- Globe not included



Part No.	TAMBURA07-10TL
Description	TABLE LAMP ES 72W SML Cylinder / Drum Cloth w/Blonde Wood
Material	Cloth shade with wood veneer trim, powder coated iron base
Lamp holder	1xE27 (Max.72W)
Dimensions	TAMBURA07-08TL: Ø150 x H460mm TAMBURA09-10TL: Ø300 x H470mm
Flex & plug	1850mm with on/off inline switch. Not dimmable
Base	TAMBURA07-08TL: Ø120mm TAMBURA09-10TL: Ø100mm
Carton QTY	TAMBURA07-08TL: 1/10 TAMBURA09-10TL: 1/1

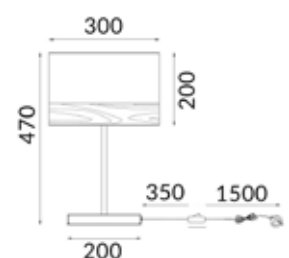
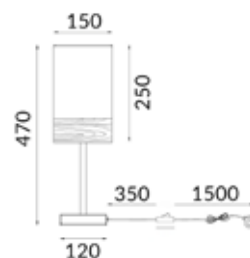

DECOR LIGHTING



TAMBURA11FL
(White)



TAMBURA12FL
(Black)

Part No.	TAMBURA11-12FL
Description	FLOOR LAMP ES 72W Large Round Cloth w/Blonde Wood
Material	Cloth shade with wood veneer trim, powder coated iron base
Lamp holder	1xE27 (Max.72W)
Dimensions	Ø400 x H1475mm
Flex & plug	1750mm with on/off inline switch. Not dimmable
Base	Ø250mm
Carton QTY	1/1



*TAMBURA pendant lights are also available



LOTUS Table & Floor Lamps



LOTUS1
(White cloth / blonde wood)



LOTUS2
(Brown cloth / dark wood)

- Interior oval cloth shade table lamps
- Material: wood & cloth
- Globe not included



Part No.	LOTUS1-2
Description	TABLE LAMP ES 40W Oval Cloth + Oval Wood Base
Material	Wood & cloth
Lamp holder	1xE27 (Max.40W)
Dimensions	W300 x H330 x D160mm
Flex & plug	1500mm with on/off inline switch. Not dimmable
Base	W300 x D100mm
Carton QTY	1/4

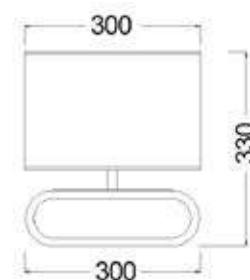

FOKUS Table & Floor Lamps



FOKUS01
(White)



FOKUS02
(Black)



FOKUS03
(Copper)



FOKUS04
(Pewter)

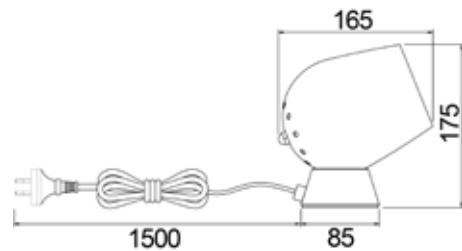

- Interior wine glass touch on/off table lamps
- Material: iron
- Globe not included
- Recommended CLA candle and fancy round LED globes



Part No.	FOKUS01-04
Description	TABLE LAMP SES 25W Wine Glass Touch Lamp + RND Base
Material	Iron
Lamp holder	1xE14 (Max.25W)
Dimensions	W165 x H175mm
Flex & plug	1500mm. Not dimmable
Base	Ø85mm
Carton QTY	1/6

PASTEL Table & Floor Lamps



PASTEL15TL
(Matte white)



PASTEL16TL
(Matte black)



PASTEL17TL
(Matte pink)



PASTEL18TL
(Matte grey)



PASTEL19TL
(Matte green)



PASTEL20TL
(Matte blue)

- Interior ellipse with adjustable head with ellipse storage base table lamps
- Material: powder coated iron
- Neck fixed, head 360° adjustable
- Globe not included



Part No.	PASTEL15-21TL
Description	TABLE LAMP SES Ellipse with Adjustable Head + Ellipse with Storage Base
Material	Powder coated iron
Lamp holder	1xE14 (Max.40W)
Dimensions	W160 x H490mm
Flex & plug	1800mm with on/off inline switch. Not dimmable
Base	Ø92mm (Can be a pen container)
Carton QTY	1/1



PASTEL21TL
(Matte yellow)



DECOR LIGHTING



- Interior ellipse with wavy edge floor lamps
- Material: powder coated iron
- Shade interior colour: white
- Globe not included



Part No.	PASTEL22-28FL
Description	FLOOR LAMP ES Ellipse with Wavy Edge with White Int Flexible + RND Base
Material	Powder coated iron
Lamp holder	1xE27 (Max.40W)
Dimensions	H1545mm
Flex & plug	2080mm with on/off inline switch. Not dimmable
Base	Ø250mm
Carton QTY	1/1

*PASTEL interior pendant lights are also available



PASTEL22FL
(Matte white)



PASTEL23FL
(Matte black)



PASTEL24FL
(Matte pink)



PASTEL25FL
(Matte grey)



PASTEL26FL
(Matte green)



PASTEL27FL
(Matte blue)



PASTEL28FL
(Matte yellow)

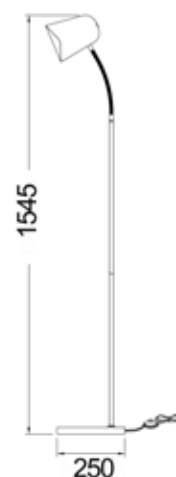

VENETO Table & Floor Lamps



VENETO-T1



VENETO-T2

- Interior cylinder with gauge black Mesh table lamps
- Material: iron
- Mesh shade can be removed
- Globe not included



Part No.	VENETO-T1 & VENETO-T2
Description	TABLE LAMP ES 72W Cylinder w/Gauge BLK Mesh + RND BLK Base
Material	Iron
Lamp holder	VENETO-T1: 1xE27 (Max.72W) VENETO-T2: 2xE27 (Max.72W)
Dimensions	H480mm
Flex & plug	1800mm with on/off inline switch. Not dimmable
Base	VENETO-T1: Ø150mm VENETO-T2: Ø100mm
Carton QTY	1/1

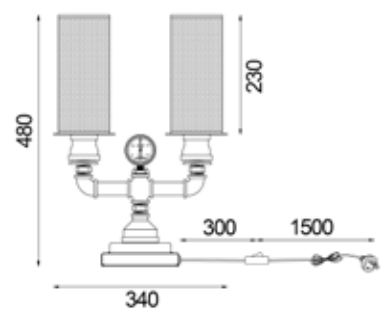
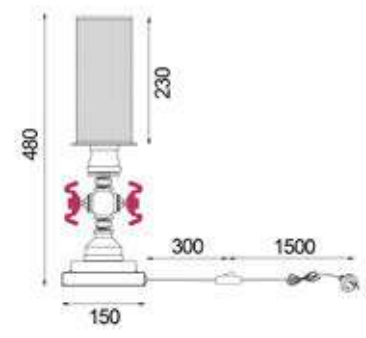

*VENETO interior pendant lights & interior wall lights are also available



DECOR LIGHTING

PUNK Table & Floor Lamps

- Interior aged iron table lamp
- Material: iron
- Globe not included



Part No.	PUNK1
Description	TABLE LAMP ES Pipe Aged Iron + RND x 2 Aged Iron Legs
Material	Iron
Lamp holder	1xE27 (Max.25W)
Dimensions	W220 x H370mm
Flex & plug	1800mm with on/off inline switch. Not dimmable
Base	Ø220mm
Carton QTY	1/1

*STEAM interior wall lights are also available

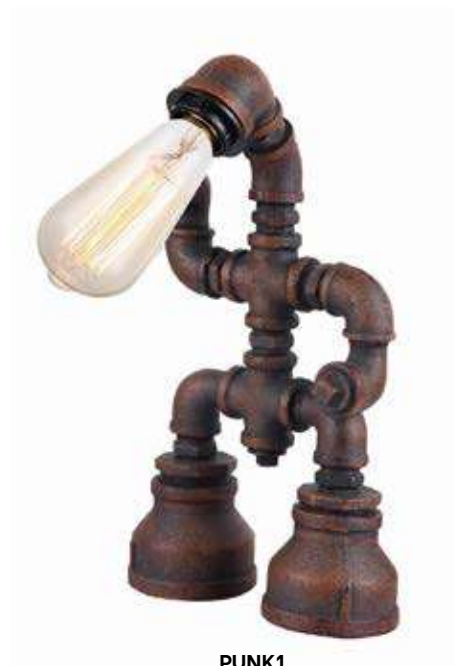

PUNK1

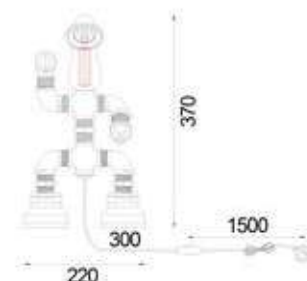

AUTUMN

- Interior table lamp
- Shade: iron with aged bronze finish
- Shade lining: PC
- Globe not included



Part No.	AUTUMN04TL
Description	TABLE LAMP ES 60W Drum Perforated (Trees) Aged Bronze + RND Aged Bronze Base
Material	Iron & PC
Lamp holder	1xE27 (Max.60W)
Dimensions	Ø220 x H520mm
Flex & plug	1500mm with on/off inline switch. Not dimmable
Base	Ø150mm
Carton QTY	1/1

*AUTUMN interior wall lights & interior wall light are also available

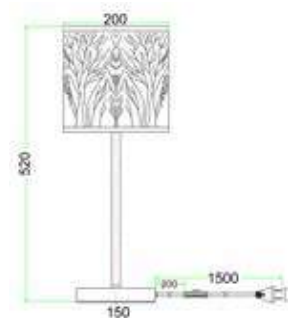

AUTUMN04TL

MOOD Table & Floor Lamps

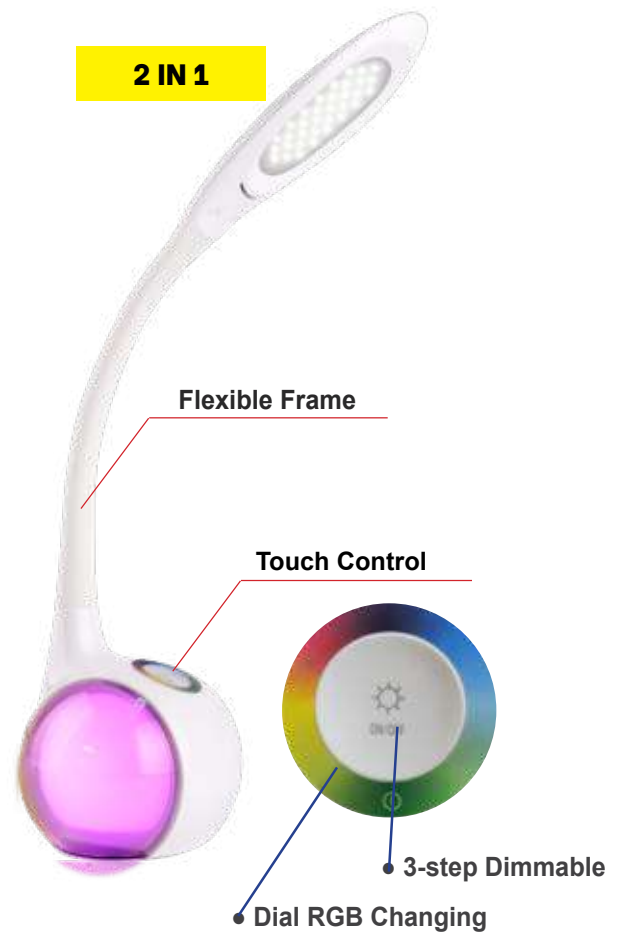

- Interior LED table lamp / Nightlight
- Input voltage: 100-240V 50/60Hz
- Can be powered by USB or plug socket
- Flexible frame/neck
- Material: Acrylonitrile-Butadiene-Styrene(ABS), Polystyrene(PS) & rubber
- Powder coated
- Wattage: 6.5W
- Power factor: 0.5
- LED chips: 34pcs SMD2835
- Flex & plug: 1.5m with USB cable
- Hold 'ON' RGB button for 3 seconds and the colours will scroll
- Ambient temperature: -20 to 40°C

Function:

- (1) touch control: 3-step dimming
- (2) Dial RGB nightlight

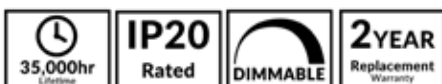

Part No.	MOOD
Description	TABLE LAMP / NIGHTLIGHT LED DIMM 6.5W WH 5200K H540mm x W115mm 3 Dimming Modes + Dial Colour Changing Base
Material	Acrylonitrile-Butadiene-Styrene (ABS), Polystyrene(PS) & Rubber
LED chips	34pcs SMD2835
Wattage	6.5W
Kelvin	6500K
Lumens	210lm
CRI	80
Dimensions	See line drawing
Flex & plug	1500mm with USB cable
Base	Ø135.4mm
Carton QTY	1/12



**DECORATIVE
INTERIOR WALL LIGHTS**

PESINI Interior Wall Lights



PESINI1W
(Clear glass)



PESINI4W
(Clear glass)



PESINI2W
(Black smoke glass)



PESINI5W
(Black smoke glass)



PESINI3W
(Amber glass)



PESINI6W
(Amber glass)

- Interior glass with antique brass / chrome highlight wall lights
- Material: glass & iron
- Adjustable swing arm
- Globe not included
- For indoor use only



Part No.	PESINI1W-6W
Description	WALL INTERNAL S/M ES 72W Wine Glass With Antique Brass /Chrome Bracket
Material	Glass & iron
Lamp holder	1xE27 (Max.72W)
Dimensions	D230 x H320mm
Back plate	Ø110 x 25mm
Carton QTY	1/1

*PESINI interior pendant lights are also available

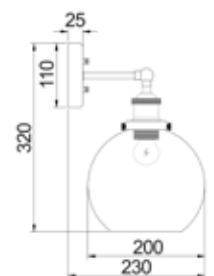

Adjustable swing arm

DECOR LIGHTING

VINUM Interior Wall Lights



VINUM1W
(Chrome glass)



VINUM2W
(Copper coloured Glass)

- Interior glass wall lights
- Material: glass
- Globe not included
- For indoor use only



Part No.	VINUM1W-2W
Description	WALL INTERNALS/M ES 72W Glass Blk Iron Bracket With Chrome High-light
Material	Glass
Lamp holder	1xE27 (Max.72W)
Dimensions	W220 x H370mm
Back plate	Ø100 x 25mm
Carton QTY	1/1

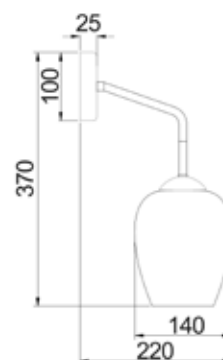

STRUNG Interior Wall Lights

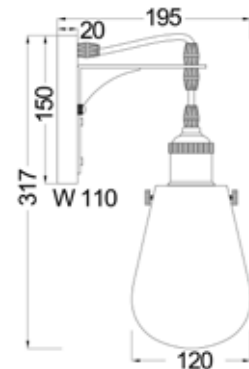

DECOR LIGHTING

- Interior surface mounted wall light
- Material: steel & glass
- Colour: black and antique bronze
- Globe not included
- For indoor use only



Part No.	STRUNG1
Description	WALL INTERNAL S/M ES 40W Black / Antique Brass and Clear Pear Shaped Glass
Material	Glass & steel
Lamp holder	1xE27 (Max.40W)
Dimensions	W120 x H317 x D195mm
Back plate	H150 x W110 x D20mm
Carton QTY	1/4

ALTA Interior Wall Lights



ALTA1W
(Matte white)



ALTA2W
(Matte black)



ALTA3W
(Matte grey)

- Interior surface mounted wall lights
- Head adjustable
- Material: iron
- Globe not included
- For indoor use only



Part No.	ALTA1W-3W
Description	WALL INTERNAL ES 72W Adj Bell (with Copper Highlights)
Material	Iron
Lamp holder	1xE27 (Max.72W)
Dimensions	Ø225 x H270mm
Back plate	Ø110mm
Carton QTY	1/10

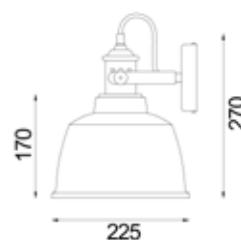

*ALTA interior pendant lights are also available



STEAM Interior Wall Lights



STEAM1



STEAM2



STEAM3

- Interior surface mounted wall lights
- Material: iron (aged finish)
- Globe not included
- For indoor use only



Part No.	STEAM1-3
Description	WALL INTERNAL S/M 72W Aged Iron Pipe
Material	Iron
Lamp holder	STEAM1: 3xE27 (Max.72W) STEAM2: 1xE27 (Max.72W) STEAM3: 4xE27 (Max.72W)
Dimensions	STEAM1: W380 x H450mm STEAM2: D190 x H380mm STEAM3: W400 x H390mm
Back plate	Ø95mm
Carton QTY	1/1

*PUNK1 table lamp is also available



VENETO Interior Wall Lights



VENETO-W1



VENETO-W2

- Interior surface mounted wall lights
- Material: iron
- Matte black finish
- Mesh shade can be removed
- Globe not included
- For indoor use only



Part No.	VENETO-W1 & VENETO-W2
Description	WALL INTERNAL S/M ES 72W BLK Iron
Material	Iron
Lamp holder	VENETO-W1: 1xE27 (Max.72W) VENETO-W2: 2xE27 (Max.72W)
Dimensions	VENETO-W1: D190 x H380mm VENETO-W2: W330 x H380mm
Back plate	Ø100mm
Carton QTY	1/1

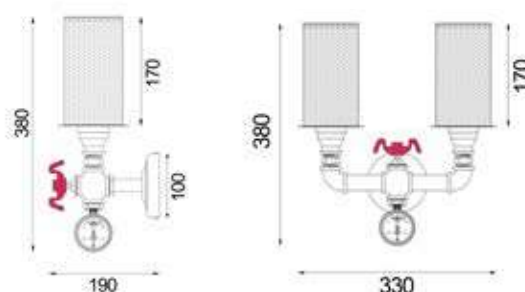

*VENETO interior pendant lights & table lamps are also available



DEKSEL Interior Wall Lights

- Interior aged copper wall lights
- Input voltage range: 110-265V AC
- Shade: aged oxidised solid copper
- Screw: stainless steel
- Globe not included
- For indoor use only



Part No.	DEKSEL02
Description	WALL INTERNAL S/M ES 60W Matte Aged Cop (Brass Bracket & Base Neck)
Material	Aged Copper
Lamp holder	1xE27 (Max.60W)
Dimensions	430 x H295mm
Back plate	200 x 25mm
Carton QTY	1/1

*DEKSEL interior pendant lights & outdoor wall lights are also available

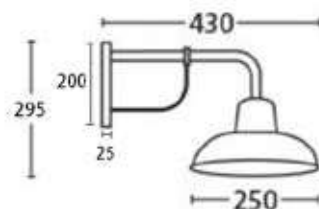

AUTUMN Interior Wall Lights

- Interior surface mounted wall light
- Shade: iron with aged bronze finish
- Shade lining: PC
- Globe not included
- For indoor use only



Part No.	AUTUMN03W
Description	WALL INTERNAL S/M SES X2 60W Curved Aged Bronze with Amber Lining
Material	Iron with aged bronze finish & PC
Lamp holder	2xE14 (Max.60W)
Dimensions	W200 x H280 x D115mm
Back plate	280 x 160mm
Carton QTY	1/1

*AUTUMN interior pendant lights & table lamp are also available

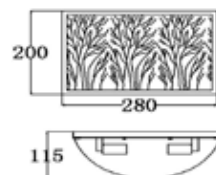

METI Interior Wall Lights

- Interior wall light
- Input voltage: 220-240V AC 50/60Hz
- Material: iron, wood & glass
- Globe not included
- For indoor use only



METI03W

Part No.	METI03W
Description	WALL INTERNAL ES Warm Chest-nut Wood Frame Clear Glass Shades and Oil Rubbed Bronze Hardware
Material	Iron, wood & glass
Lamp holder	1xE27 (Max.60W)
Dimensions	W252 x H340 x D184mm
Back plate	Please see line drawing
Carton QTY	1/1

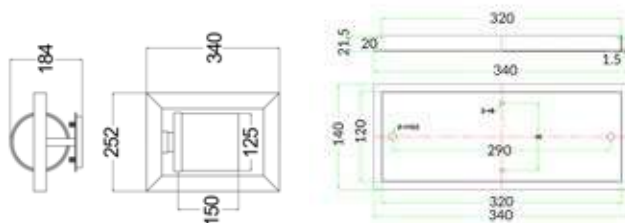

*METI interior pendant lights are also available



SPUTNIK Interior Wall Lights

- Interior surface mounted wall light
- Shade: polished nickel/ dark-light grey washed wood
- Globe not included
- For indoor use only



SPUTNIK2

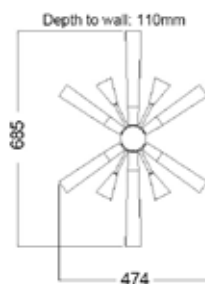

Part No.	SPUTNIK2
Description	WALL INTERNAL ES X 4 Polished Nickel/ Dark-Light Grey Washed
Material	Wood
Lamp holder	4xE27 (Max.60W)
Dimensions	W474 x H685 x D110mm
Back plate	340x140mm
Carton QTY	1/1

*SPUTNIK interior pendant light is also available





- Interior LED surface mounted wall lights
- LYON is recessed wall light
- Ideal to create ambient lighting
- Low energy long life LED chips
- 12V inbuilt constant current driver included
- Ambient temperature: -20 to 50°C
- For residential and indoor use only
- Suitable for 2 way switching
- Suitable for use with PIR or Microwave sensor

Part No.	ATHENSG2
Description	WALL INTERNAL S/M CITY LED Matte WH Oval 1 Way
Material	Aluminium, iron & acrylic
Kelvin	3000K
Lumens	460LM
Wattage	6W
LED chips	36pcs 2835
Dimensions	D 93 x W 265mm
Back plate	L 100 x W 50 x 30mm
Carton QTY	1/12

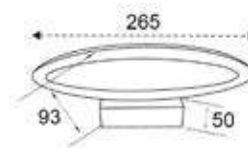

Part No.	BARCELONA
Description	WALL INTERNAL S/M CITY LED Clear Border / Frosted Inner Rect / Brushed S/C Plate
Material	Aluminium, brushed S/C, acrylic & iron
Kelvin	3000K
Lumens	614LM
Wattage	10W
LED chips	160pcs 2835
Dimensions	L 360 x W 135 x D 40mm
Back plate	L 310 x W 45mm
Carton QTY	1/12

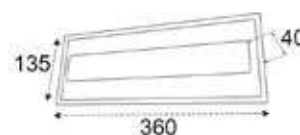

DECOR LIGHTING

Part No.	CANNES
Description	WALL INTERNAL S/M CITY LED Matte WH Curved Up/DN
Material	Aluminium
Kelvin	3000K
Lumens	468LM
Wattage	6W
LED chips	12pcs 5630
Dimensions	L 250 x W 100 x D 91mm
Back plate	L 120 x W 60 x 35mm
Carton QTY	1/12

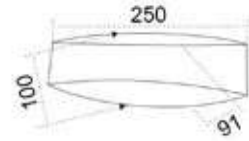

Part No.	DAVOS
Description	ALL INTERNAL S/M CITY LED MATT WH BOW
Material	Iron, Aluminium WH & Acrylic
Kelvin	3000K
Lumens	480LM
Wattage	16W
LED chips	1pc 2835 COB LED
Dimensions	L 220 x W 160 x D 115mm
Back plate	L 120 x W 40 x 45mm
Carton QTY	1/12

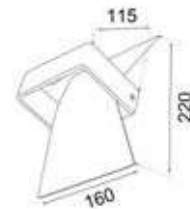

Part No.	DELHI
Description	WALL INTERNAL Angled Up/ Down S/M CITY LED Sand WH
Material	Aluminium, acrylic & iron
Kelvin	3000K
Lumens	469LM
Wattage	12W
LED chips	24pcs 2835
Dimensions	L 202 x W 181 x D 100mm
Back plate	L 130 x W 60mm
Carton QTY	1/12



Part No.	DUBAIG2
Description	WALL INTERNAL S/M CITY LED Matte WH Curved
Material	Aluminium, iron & acrylic
Kelvin	3000K
Lumens	460LM
Wattage	6W
LED chips	36pcs 2835
Dimensions	262 x 155 x 85mm
Back plate	L 180 x W 60 x 35mm (Mounting U bracket: 170x30mm, Central 7mm cable hole)
Carton QTY	1/12

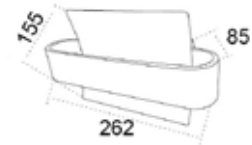

Part No.	GENEVA
Description	WALL INTERNAL S/M CITY LED Matte WH Curved
Material	Aluminium, iron & acrylic
Kelvin	3000K
Lumens	822LM
Wattage	10W
LED chips	60pcs 2835
Dimensions	262x100x102mm
Back plate	L 160 x W 70 x 22mm (Mouting U bracket: 150x22mm, central 7mm cable hole)
Carton QTY	1/12

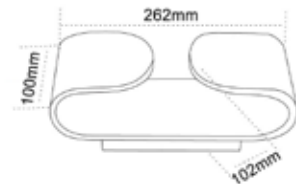

Part No.	LONDON
Description	WALL INTERNAL S/M CITY LED Matte WH Cube UP/DN
Material	Aluminium
Kelvin	3000K
Lumens	450LM
Wattage	6W
LED chips	6pcs 5050
Dimensions	100x100x85mm
Back plate	L 100 x W 85 x 27mm (Mouting U bracket: 60x25mm)
Carton QTY	1/12

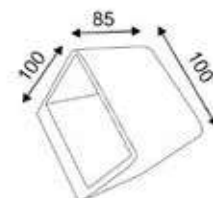

Part No.	MILAN
Description	WALL INTERNAL S/M CITY LED Matte WH Tube UP/DN
Material	Aluminium, iron & acrylic
Kelvin	3000K
Lumens	448LM
Wattage	6W
LED chips	12pcs 5630
Dimensions	300x70x90mm
Back plate	L 100 x W 70 x 30mm (Mounting U bracket: 60x20mm)
Carton QTY	1/12

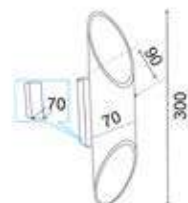

Part No.	NEW YORKG2
Description	WALL INTERNAL S/M CITY LED S/ Nickel with Clear Acrylic Border Rect UP/DN
Material	Aluminium, iron & acrylic
Kelvin	3000K
Lumens	360LM
Wattage	6W
LED chips	36pcs 2835
Dimensions	L 170 x W 100 x D 68mm
Back plate	L140 x W 40 x 30mm (Mounting U bracket: 130x20mm, central 7mm cable hole)
Carton QTY	1/12

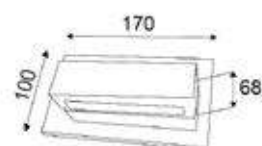

Part No.	PARIS
Description	WALL INTERNAL S/M CITY LED S/C Adj Picture
Material	Iron, copper S/nickel
Kelvin	3000K
Lumens	611LM
Wattage	6W
LED chips	66pcs 2835
Dimensions	W 453 x D 208mm
Back plate	L 100 x W 45 x 25mm (Mouting U bracket: 90x20mm, central 25mm cable hole)
Carton QTY	1/12

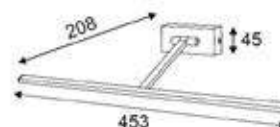

Part No.	PHOENIX
Description	WALL INTERNAL S/M CITY LED Matte WH Curved Uplight
Material	Aluminium, iron & acrylic
Kelvin	3000K
Lumens	395LM
Wattage	6W
LED chips	6pcs 5050
Dimensions	L 200 x W 60 x D 106mm
Back plate	L 90 x W 60mm (Mounting U bracket: 100x20mm, 25mm cable entry off to one side)
Carton QTY	1/12

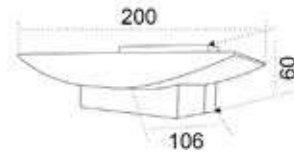

Part No.	RIOG2
Description	WALL INTERNAL S/M CITY LED Matte WH Rect Uplight 90D ADJ
Material	Aluminium, iron, copper WH & acrylic
Kelvin	3000K
Lumens	244LM
Wattage	2x3W
LED chips	2pcs 5050
Dimensions	L 140 x W 90 x D 120mm
Back plate	L100 x W 45 x 30mm (Mounting U bracket: 90x20mm, 25mm cable entry off to one side)
Carton QTY	1/12

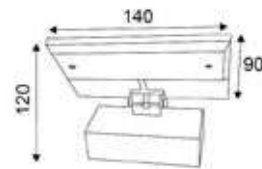

Part No.	ROME2
Description	WALL INTERNAL S/M CITY LED S/C TUBULAR Up/Dn
Material	Iron, aluminium s/chrome & acrylic diffuser
Kelvin	3000K
Lumens	230LM
Wattage	2x1W
LED chips	2pcs 3535
Dimensions	L 242 x W 80 x D 52mm
Back plate	L 100 x W 45 x 30mm (Central 25mm cable hole)
Carton QTY	1/12

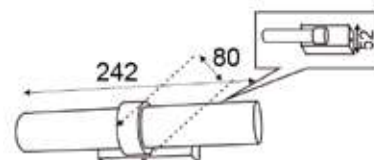

Part No.	SYDNEYG2
Description	WALL INTERNAL S/M CITY LED S/N Curved Frosted DIFF
Material	Aluminium & acrylic
Kelvin	3000K
Lumens	460LM
Wattage	6W
LED chips	36pcs 2835
Dimensions	L 250 x W 30 x D 108mm
Back plate	L 180 x W 30 x 35mm (with 2x20mm cable holes 35mm from each other)
Carton QTY	1/12

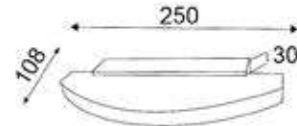

Part No.	VENICEG2
Description	WALL INTERNAL S/M CITY LED Matte WH Rect UP/DN
Material	Aluminium & iron
Kelvin	3000K
Lumens	615LM
Wattage	6W
LED chips	36pcs 2835
Dimensions	L 195 x W 36 x D 115mm
Back plate	L170 x W 36 x 30mm (Central 7mm cable entry)
Carton QTY	1/12

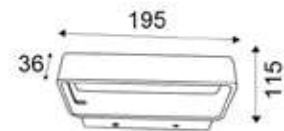

Part No.	VIENNA
Description	WALL INTERNAL S/M CITY LED Matte WH Rect with Clear / Frost Ribbed Diffuser
Material	Iron, aluminium & acrylic
Kelvin	3000K
Lumens	803LM
Wattage	12W
LED chips	12pcs 5050
Dimensions	L 320 x W 120 x D 80mm
Back plate	L 308 x W 90 x 38mm (Mounting plate: 160x30mm, central 7mm cable entry)
Carton QTY	1/12

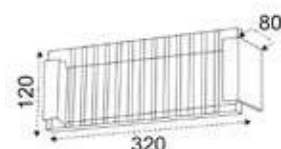

Part No.	SEATTLE1
Description	WALL INTERNAL S/M CITY LED ADJ Bar Chrome
Material	Iron aluminium, chrome & acrylic frosted diffuser
Kelvin	3000K
Lumens	283LM
Wattage	3W
LED chips	3pcs 5050
Dimensions	L 90 x Ø90mm
Back plate	L90 x W 50 x D 35mm
Carton QTY	1/12

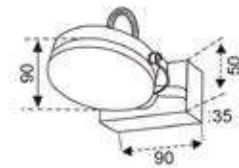

Part No.	SEATTLE2
Description	WALL INTERNAL S/M CITY LED ADJ 2LT Bar Chrome
Material	Iron aluminium, chrome & acrylic frosted diffuser
Kelvin	3000K
Lumens	563LM
Wattage	2x3W
LED chips	6pcs 5050
Dimensions	L 314 x Ø90mm
Back plate	L 314 x W 45 x D 25mm
Carton QTY	1/12

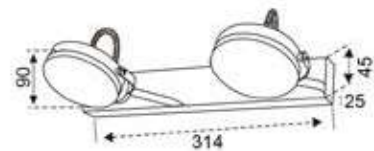

Part No.	SEATTLE3
Description	WALL INTERNAL S/M CITY LED ADJ 3LT Bar Chrome
Material	Iron aluminium, chrome & acrylic frosted diffuser
Kelvin	3000K
Lumens	840LM
Wattage	3x3W
LED chips	9pcs 5050
Dimensions	L 524 x Ø90mm
Back plate	L 524 x W 45 x D 25mm
Carton QTY	1/12

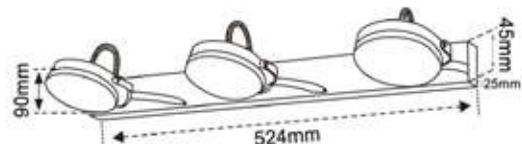

Part No.	LYON
Description	WALL LED S/M Adj Reading Light WH 3W
Material	Aluminium alloy, iron back plate
Kelvin	3000K
Lumens	342LM
Wattage	3W
LED chips	1pc 3535
Dimensions	120x60mm
Cut out	110x30mm
Back plate	120x60mm
Carton QTY	1/12
<i>NOTE: Head is rotatable. Inclusion: on/off switch on back plate</i>	

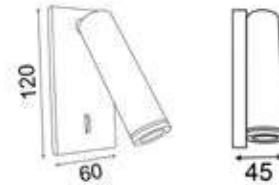

Part No.	VIGOL
Description	WALL INTERNAL S/M CILED Matte WH 2 switch FR Glass Deco & Left Oriented Reading Light (w/USB charger)
Material	Iron, aluminium & acrylic
Kelvin	3000K
Lumens	900LM
Wattage	6W (Main lamp) + 3W (reading light)
LED chips	30pcs 2835 (main lamp) + 1pc 3535 (reading light)
Dimensions	L 240 x W 237 x D 152mm
Back plate	210 x 80mm
Carton QTY	1/6

Independent switches on mounting base, 5V 2A USB charger in side of mounting base, shelf for safe support of device being charged, reading light is rotatable

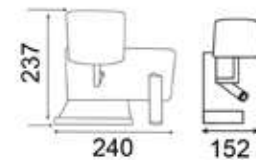

Part No.	VIGOR
Description	WALL INTERNAL S/M LED Matte WH 2 switch FR Glass Decorative & Right Oriented Reading Light (w/USB charger)
Material	Iron, aluminium & acrylic
Kelvin	3000K
Lumens	900LM
Wattage	6W (Main lamp) + 3W (reading light)
LED chips	30pcs 2835 (main lamp) + 1pc 3535 (reading light)
Dimensions	L 240 x W 237 x D 152mm
Back plate	210 x 80mm
Carton QTY	1/6

Independent switches on mounting base, 5V 2A USB charger in side of mounting base, shelf for safe support of device being charged, reading light is rotatable

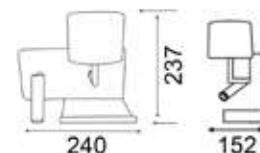

Part No.	BRIGHTON01
Description	WALL INTERNAL S/M ES (60W) Flaxen Shade + LED (3W) Adj Matte WH Reading Light
Material	Cloth shade, aluminium back plate, iron mounting bracket
Lamp holder (main lamp)	1xE27 (Max.60W HAL)
Wattage (reading light)	3W
Kelvin (reading light)	3000K
Lumens (reading light)	278LM
LED chips (reading light)	1pc 3535
Dimensions	L 282 x W 160 x D 193mm
Back plate	L 140 x W 120mm, 2xON/OFF switch on bottom of back plate
Carton QTY	1/6

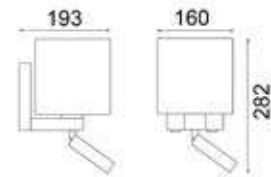

Part No.	BRIGHTON02
Description	WALL INTERNAL S/M ES (60W) Flaxen Shade + LED (3W) Adj Matte WH Reading Light
Material	Cloth shade, aluminium back plate, iron mounting bracket
Lamp holder (main lamp)	1xE27 (Max.60W HAL)
Wattage (reading light)	3W
Kelvin (reading light)	5000K
Lumens (reading light)	298LM
LED chips (reading light)	1pc 3535
Dimensions	L 282 x W 160 x D 193mm
Back plate	L 140 x W 120mm, 2xON/OFF switch on bottom of back plate
Carton QTY	1/6

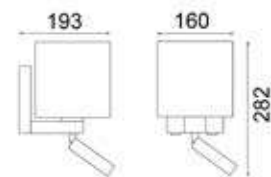

Part No.	CHESTER01
Description	WALL INTERNAL S/M ADJ LED 6W WH 1 switch Clear PS Shade
Material	Aluminium housing, PS shade, iron mounting bracket
Kelvin	3000K
Lumens	402LM
Wattage	6W
LED chips	30pcs 2835
Dimensions	L 180 x W 130 x D 173.5mm
Back plate	180 x 50mm
Carton QTY	1/6

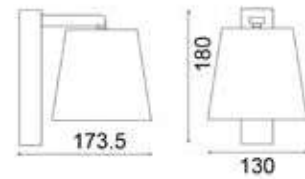

Part No.	CHESTER02
Description	WALL INTERNAL S/M ADJ LED 6W WH 1 switch Clear PS Shade
Material	Aluminium housing, PS shade, iron mounting bracket
Kelvin	5000K
Lumens	480LM
Wattage	6W
LED chips	30pcs 2835
Dimensions	L 180 x W 130 x D 173.5mm
Back plate	180 x 50mm
Carton QTY	1/6

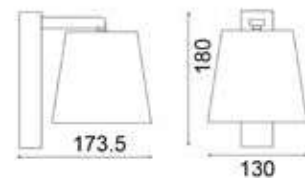

VANITY Interior Wall Lights



VANITY-1
(L490mm)



VANITY-2
(L810mm)

- Interior LED surface mounted wall lights
- Input voltage: 240V AC 50/60Hz
- 12V driver included
- Shade: Iron & stainless steel
- Diffuser: acrylic opal
- Chrome finish
- CRI: >80
- Ideal for creating ambient lighting
- Low energy longlife LED lighting
- Not suitable for dimming

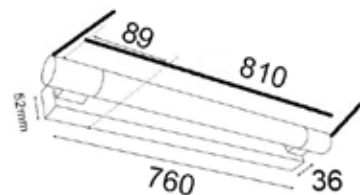
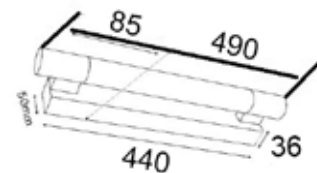

Part No.	VANITY-1
Description	WALL INTERNAL S/M VANITY LED CHROME Frosted Acrylic Diffuser SHORT
Material	Iron, stainless steel, acrylic opal
Kelvin	4000K
Lumens	525LM
Wattage	7.68W
CRI	>80
LED chips	-
Dimensions	L 490 x W 50 x D 85mm
Back plate	L 440 x W 36 x D 50mm
Carton QTY	1/12

Part No.	VANITY-2
Description	WALL INTERNAL S/M VANITY LED CHROME Frosted Acrylic Diffuser LONG
Material	Iron, stainless steel, acrylic opal
Kelvin	4000K
Lumens	986LM
Wattage	19.2W
CRI	>80
LED chips	-
Dimensions	L 810 x W 52 x D 89mm
Back plate	L 760 x W 36 x D 52mm
Carton QTY	1/6



DECORATIVE
D.I.Y. DECOR



DIYBAT01
(Black/ clear glass)



DIYBAT02
(Chrome/ clear glass)



DIYBAT03
(Black/ smokey glass)



DIYBAT04
(Chrome/ smokey glass)

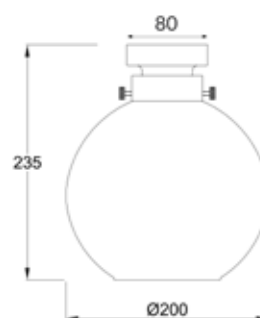

- D.I.Y. wine glass batten fitting
- Input voltage range: 220-240V AC
- Surface mounted
- Material: iron & glass
- Globe type: B22 (Max.40W)
- Globe not included
- Batten holder not included

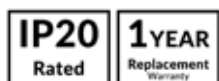

Part No.	DIYBAT01-04
Description	DIY Batten Fitting Wine Glass Clr/ Smokey
Material	Iron & glass
Lamp Holder	-
Dimensions	Ø200 x H 235mm
Back plate	Ø80mm
Carton QTY	1/8



DIYBAT05
(Black/ clear glass)



DIYBAT06
(Chrome/ clear glass)



DIYBAT07
(Black/ smokey glass)



DIYBAT08
(Chrome/ smokey glass)

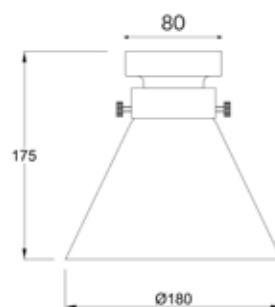

- D.I.Y. cone (flat top) batten fitting
- Input voltage range: 220-240V AC
- Surface mounted
- Material: iron & glass
- Globe type: B22 (Max.40W)
- Globe not included
- Batten holder not included

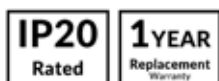

Part No.	DIYBAT05-08
Description	DIY Batten Fitting SML Cone Clr/ Smokey
Material	Iron & glass
Lamp Holder	-
Dimensions	Ø180 x H 175mm
Back plate	Ø80mm
Carton QTY	1/12



DIYBAT09
(Black/ clear glass)



DIYBAT10
(Chrome/ clear glass)



DIYBAT11
(Black/ smokey glass)



DIYBAT12
(Chrome/ smokey glass)

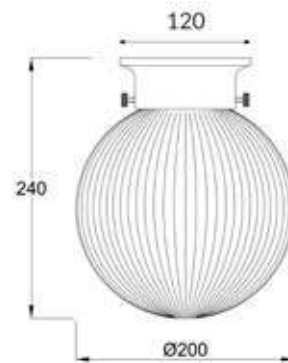

- D.I.Y. sphere ribbed batten fitting
- Input voltage range: 220-240V AC
- Surface mounted
- Material: iron & glass
- Globe type: B22 (Max.40W)
- Globe not included
- Batten holder not included



Part No.	DIYBAT09-12
Description	DIY Batten Fitting LGE Spherical Ribbed Clr/ Smokey
Material	Iron & glass
Lamp Holder	-
Dimensions	Ø200 x H 240mm
Back plate	Ø120mm
Carton QTY	1/8



DIYBAT13
(Black/ clear glass)



DIYBAT14
(Chrome/ clear glass)



DIYBAT15
(Black/ smokey glass)



DIYBAT16
(Chrome/ smokey glass)

- D.I.Y. coolie batten fitting
- Input voltage range: 220-240V AC
- Surface mounted
- Material: iron & glass
- Globe type: B22 (Max.40W)
- Globe not included
- Batten holder not included

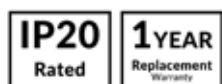

Part No.	DIYBAT13-16
Description	DIY Batten Fitting LGE Coolie Clr/ Smokey
Material	Iron & glass
Lamp Holder	-
Dimensions	Ø300 x H 145mm
Back plate	Ø80mm
Carton QTY	1/4

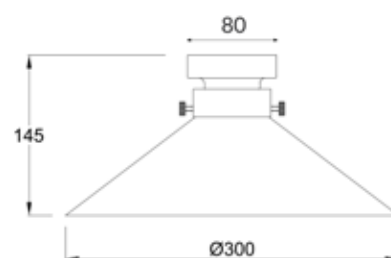



DIYBAT17
(Black/ clear glass)



DIYBAT18
(Chrome/ clear glass)



DIYBAT19
(Black/ smokey glass)



DIYBAT20
(Chrome/ smokey glass)

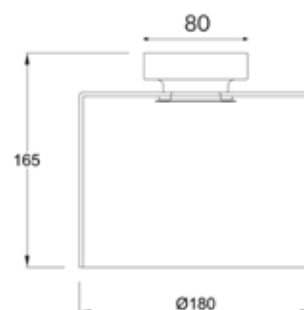

- D.I.Y. cylinder batten fitting
- Input voltage range: 220-240V AC
- Surface mounted
- Material: iron & glass
- Globe type: B22 (Max.40W)
- Globe not included
- Batten holder not included

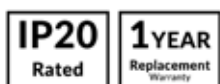

Part No.	DIYBAT17-20
Description	DIY Batten Fitting Oblong Clr/ Smokey OD180mm
Material	Iron & glass
Lamp Holder	-
Dimensions	Ø180 x H 165mm
Back plate	Ø80mm
Carton QTY	1/12



DIYBATC01
(Copper)



DIYBATC02
(Polished brass)



DIYBATC03
(Antique brass)



DIYBATC04
(Chrome)



DIYBATC05
(Black)



DIYBATC06
(White)

- D.I.Y. cone (flat top) batten fitting cover
- Input voltage range: 220-240V AC
- Surface mounted
- Material: iron
- Globe type: B22 (Max.40W)
- Globe not included
- Batten holder not included



Part No.	DIYBATC01-06
Description	DIY Batten Fitting Cover
Material	Iron
Lamp Holder	-
Dimensions	Ø90 x H 70mm
Back plate	Ø90mm
Carton QTY	1/24

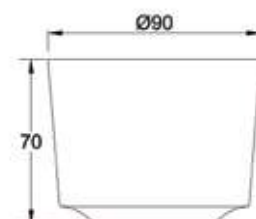

SHADE D.I.Y. Decor



SHADE01
(White)



SHADE02
(Black)



SHADE03
(Grey)



SHADE04
(Natural)

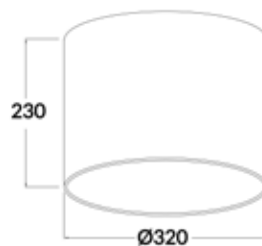

Adjustable Wireframe

- D.I.Y. drum lampshade
- Adjustable wireframe: iron (white)
- Shade: linen
- Lining: PVC (white)
- Versatile: suits table lamps, floor lamps, pendant lights or mount it on ceiling with a batten holder
- Includes adaptor rings to suit bigger lamp holders

Part No.	SHADE01-04
Description	DIY Drum Lampshade
Material	Iron, linen & PVC
Lamp Holder	-
Dimensions	Ø320 x H 230mm
Carton QTY	1/1





SHADE05
(White)



SHADE06
(Black)



SHADE07
(Grey)



SHADE08
(Natural)

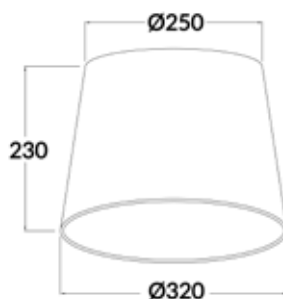

Adjustable Wireframe

- D.I.Y. slant lampshade
- Adjustable wireframe: iron (white)
- Shade: linen
- Lining: PVC (white)
- Versatile: suits table lamps, floor lamps, pendant lights or mount it on ceiling with a batten holder
- Includes adaptor rings to suit bigger lamp holders



Part No.	SHADE05-08
Description	DIY Slant Lampshade
Material	Iron, linen & PVC
Lamp Holder	-
Dimensions	Ø250 / Ø320 x H 230mm
Carton QTY	1/1



EXTERIOR LIGHTING



RUBIK1
(Matte black)



RUBIK2
(Matte white)

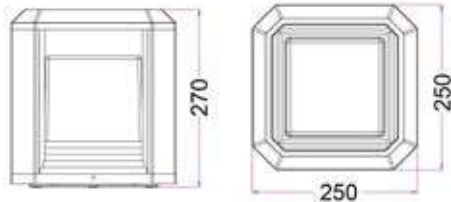

- Exterior LED cube wall / floor lamps
- Input voltage range: 100-240V AC 50/60Hz
- Constant current driver included
- Shade: double anti-corrosion powder coated high-pressure casted aluminium
- Shade internal colour: white
- Diffuser: anti aging UV protected PC
- LED chips: 20pcs 3030
- Power factor: >0.5
- Ambient temperature: -20 to 50°C
- Not suitable for dimming
- Suitable for 2 way switching
- Suitable for use with PIR or Microwave sensors

Part No.	RUBIK1-2
Description	WALL / FLOOR LED 240V S/M Cube 4 Way Post Top with WH + FLUSH Base
Material	Aluminium & PC
Kelvin	3000K
Lumens	RUBIK1: 1071LM; RUBIK2: 850LM
Wattage	20W
CRI	>80
Dimensions	W 250 x H 270mm
Back plate	Ø110x D20mm
Carton QTY	1/2



*To avoid disappointment and warranty problems, please ensure the IP Rating of the chosen product is relevant for the intended use.



SPY-C1
(Matte white)

SPY-C2
(Matte black)



SPY-W1
(Matte white)

SPY-W2
(Matte black)

- Exterior pendant & surface mounted wall lights
- Input voltage range: 220-240V AC 50/60Hz
- Shade: aluminium
- Diffuser: glass
- Lamp holder: E27 (Max.60W HAL/ 10W LED)
- Globes not included

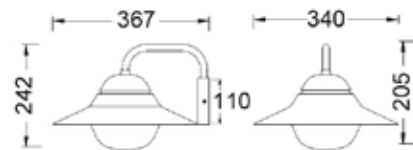

Part No.	SPY-C1, SPY-C2
Description	PENDANT EXTERIOR ES 60W Sun Hat w/FR Diff + RND Canopy
Material	Aluminium & glass
Lamp Holder	1xE27 (Max.60W HAL/ 10W LED)
Dimensions	Ø340 x H 205mm
Suspension	3m cable
Canopy	Ø110mm
Carton QTY	1/4

Part No.	SPY-W1, SPY-W2
Description	WALL ES 60W Sun Hat w/FR Diff + RND Base
Material	Aluminium & glass
Lamp Holder	1xE27 (Max.60W HAL/ 10W LED)
Dimension	367 x H 242mm
Back plate	Ø110x D20mm
Carton QTY	1/1

*Unless protected, not recommended for environments with harsh weather conditions or heavy rainfall. IP65 fittings recommended for such environments.

*To avoid disappointment and warranty problems, please ensure the IP Rating of the chosen product is relevant for the intended use.



TREEC

- Exterior tree / single pendant light
- Input voltage: 12V DC/AC
- External Control Gear Required
- Recommended CLA LED driver: OTTER1
- Lamp holder: MR11 (Replaced by removing cylinder from canopy - held by 1 screw) (Max.20W)
- Globe not included
- Recommended CLA LED MR11 Globes

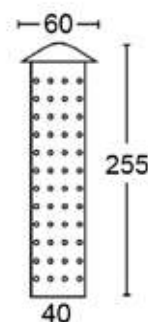

Part No.	TREEC
Description	TREE / PENDANT EXTERIOR MR11 12V Cylinder Perforated (Holes) COP + Br chain
Material	Solid copper
Lamp Holder	1xMR11 (Max.20W)
Dimensions	Ø60 x H 255mm
Suspension	50mm chain & 950mm cable
Carton QTY	1/1

**Unless protected, not recommended for environments with harsh weather conditions or heavy rainfall. IP65 fittings recommended for such environments.*

**To avoid disappointment and warranty problems, please ensure the IP Rating of the chosen product is relevant for the intended use.*



DEKSEL01

- Exterior surface mounted wall light
- Input voltage range: 110-265V AC
- Shade: aged oxidised solid copper
- Screw: stainless steel
- Lamp holder: E27 (Max.60W)
- Globe not included



Part No.	DEKSEL01
Description	WALL ES 60W Sun Hat Aged COP w/Gooseneck + RND COP Base
Material	Aged oxidised solid copper
Lamp holder	1xE27 (Max.60W)
Dimensions	400x320mm
Back plate	115x25mm
Carton QTY	1/4

**DEKSEL interior wall light and interior pendant light are also available*



**Unless protected, not recommended for environments with harsh weather conditions or heavy rainfall. IP65 fittings recommended for such environments.*

**To avoid disappointment and warranty problems, please ensure the IP Rating of the chosen product is relevant for the intended use.*



SKOPA1
(Galvanized steel)



SKOPA2
(Copper)

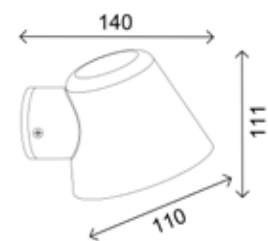

- Exterior surface mounted wall lights
- Input voltage range: 220-240V AC 50/60Hz
- Material: galvanized steel or copper
- Lamp holder: GU10 (Max.35W)
- Globes not included



Part No.	SKOPA1, SKOPA2
Description	WALL GU10 S/M Cone (Flat Top) + RND FLUSH Base
Material	Galvanized steel/ copper
Lamp holder	1xGU10 (Max.35W)
Dimensions	Ø110 x H 111 x D 140mm
Back plate	Ø50x D35mm
Carton QTY	1/12

*Unless protected, not recommended for environments with harsh weather conditions or heavy rainfall. IP65 fittings recommended for such environments.

*To avoid disappointment and warranty problems, please ensure the IP Rating of the chosen product is relevant for the intended use.



MAGNUM1
(Matte white)



MAGNUM2
(Matte black)

- Exterior surface mounted wall lights
- Input voltage range: 220-240V AC 50/60Hz
- Housing: aluminium
- Diffuser: glass
- Lamp holder: E27 (Max.40W HAL/8W LED)
- Globes not included



Part No.	MAGNUM1, MAGNUM2
Description	WALL ES 40W S/M Cylinder + Flush Base
Material	Die cast aluminium
Lamp holder	1xE27 (Max.40W HAL/ 8W LED)
Dimensions	W 106 x H 216 x D 134mm
Back plate	L 100 x W 55 x D 35mm
Carton QTY	1/6

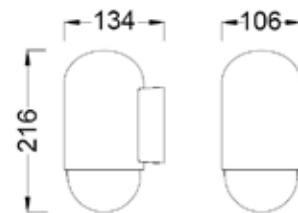

**Unless protected, not recommended for environments with harsh weather conditions or heavy rainfall. IP65 fittings recommended for such environments.*

**To avoid disappointment and warranty problems, please ensure the IP Rating of the chosen product is relevant for the intended use.*



HINK1
(Matte black)



HINK2
(Matte white)

- Exterior surface mounted wall lights
- Input voltage range: 220-240V AC 50/60Hz
- Material: aluminium
- Lamp holder: E27 (Max.60W)
- Globes not included



Part No.	HINK1, HINK2
Description	WALL ES 60W S/M Ellipse with Cage w/Gooseneck + RND Base
Material	Aluminium
Lamp holder	1xE27 (Max.60W)
Dimensions	Ø204 x H 378 x D 260mm
Back plate	Ø105x D20mm
Carton QTY	1/6

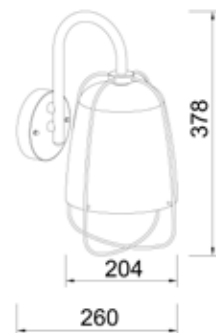

*Unless protected, not recommended for environments with harsh weather conditions or heavy rainfall. IP65 fittings recommended for such environments.

*To avoid disappointment and warranty problems, please ensure the IP Rating of the chosen product is relevant for the intended use.



TORQUE1
(Matte white)



TORQUE2
(Matte black)

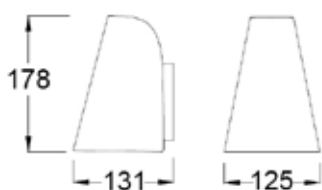

- Exterior surface mounted wall lights
- Input voltage range: 220-240V AC 50/60Hz
- Housing: aluminium
- Diffuser: glass
- Lamp holder: E27 (Max.60W HAL/8W LED)
- Globes not included



Part No.	TORQUE1, TORQUE2
Description	WALL ES 60W Cone (Flat Top) + Flush Base
Material	Aluminium & glass
Lamp holder	1xE27 (Max.60W HAL/ 8W LED)
Dimensions	W 125 x H 178 x D 131mm
Back plate	L 100 x W 50 x D 15mm
Carton QTY	1/12

**Unless protected, not recommended for environments with harsh weather conditions or heavy rainfall. IP65 fittings recommended for such environments.*

**To avoid disappointment and warranty problems, please ensure the IP Rating of the chosen product is relevant for the intended use.*



TORQUE3 & TORQUE4

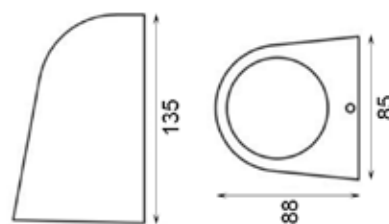

- Exterior surface mounted wall lights
- Single fixed head
- Input voltage range: 110-265V AC or 12-24V AC
- Housing: solid brass
- Diffuser: glass
- Lamp holder: GU10 or MR16
- Globes not included



Part No.	TORQUE3
Description	WALL GU10 35W Ellipse Antique Brass + Flush Base
Material	Solid brass & glass
Lamp holder	1xGU10 (Max.35W)
Dimensions	W 85 x H 135 x D 88mm
Back plate	135x85mm
Carton QTY	1/10

Part No.	TORQUE4
Description	WALL MR16 20W Ellipse Antique Brass + Flush Base
Material	Solid brass & glass
Lamp holder	1xMR16 (Max.20W)
Dimensions	W 85 x H 135 x D 88mm
Back plate	135x85mm
Carton QTY	1/10

*To avoid disappointment and warranty problems, please ensure the IP Rating of the chosen product is relevant for the intended use.



MIDO01

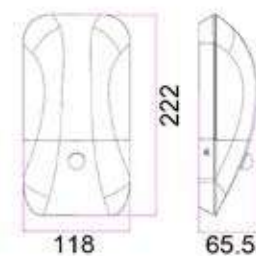

- Exterior LED sensor surface mounted wall light
- Input voltage range: 220-240V AC 50/60Hz
- Inbuilt Constant Current LED driver
- Housing & heatsink: aluminium
- Diffuser: PC
- Mounting plate: aluminium
- LED chips: 50pcs 2835
- Power factor: >0.8
- CRI: >80
- Ambient temperature: -20 to 50°C
- Not suitable for dimming
- Suitable for 2-way switching

Sensor Details

- Sensor type: infrared
- Installation height: 1.8-2.5m
- Detection angle: 120° / 360°
- Motion detection distance: 3-6m
- Motion detection speed: 0.6-1.5m/s
- Hold time: 5s, 30s, 1m, 3m, 5m, 8m (adjustable)



Part No.	MIDO01
Description	WALL LED SENSOR S/M RECT (RND) Eyelid w/Sensor IP54 Dark Grey + Flush Base
Material	Powder coated aluminium
LED chips	50pcs 2835
Kelvin	3000K
Lumens	840LM
Wattage	11W
CRI	>80
Beam angle	125°
Dimensions	H 222 x W 118 x D 65.5mm
Back plate	222 x 118mm
Carton QTY	1/12

**Unless protected, not recommended for environments with harsh weather conditions or heavy rainfall. IP65 fittings recommended for such environments.*

**To avoid disappointment and warranty problems, please ensure the IP Rating of the chosen product is relevant for the intended use.*

SOMBRA Exterior Lighting



SOMBRA01
(Dark Grey)

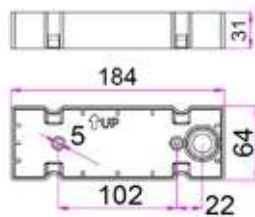
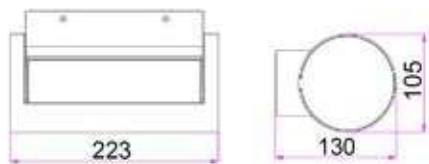

Back plate

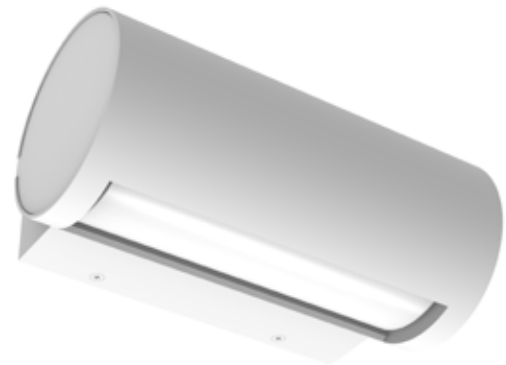

SOMBRA02
(White)

- Exterior LED adjustable eyelid surface mounted wall lights
- Input voltage range: 100-240V AC 50/60Hz
- Inbuilt Constant Current driver included
- Housing & heatsink: aluminium
- Diffuser: UV resistant PC
- Back plate: aluminium
- Power factor: >0.9
- CRI: >80
- 180° adjustable cap
- LED chips: 12pcs 3030
- Ambient temperature: -20 to 50°C
- Not suitable for dimming
- Suitable for 2-way switching
- Suitable for use with PIR sensor



Part No.	SOMBRA01, SOMBRA02
Description	WALL LED S/M Cylinder Rotating IP65 + RECT Base
Material	Aluminium & PC
LED chips	12pcs 3030
Kelvin	3000K
Lumens	380LM
Wattage	13W
Power factor	>0.9
CRI	>80
Beam angle	114°
Dimensions	Please see the line drawing
Back plate	184x64x31mm
Carton QTY	1/8

*To avoid disappointment and warranty problems, please ensure the IP Rating of the chosen product is relevant for the intended use.



BOCINA01
(Dark grey)



BOCINA02
(White)

- Exterior LED surface mounted semicircle wall lights
- Input voltage range: 100-240V AC 50/60Hz
- Inbuilt Constant Current driver included
- Housing & heatsink: aluminium
- Diffuser: UV resistant PC
- Back plate: aluminium
- LED chips: 14pcs SMD2835
- Ambient temperature: -20 to 50°C
- Not suitable for dimming
- Suitable for 2 way switching
- Suitable for use with PIR sensor

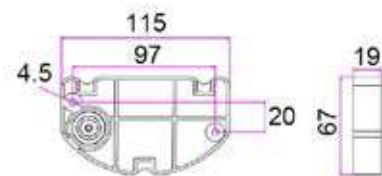
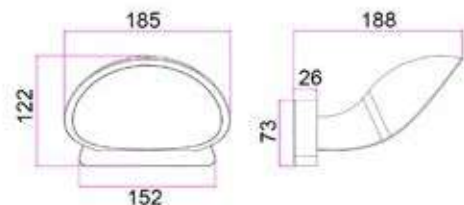

Back plate

Part No.	BOCINA01, BOCINA02
Description	WALL LED S/M Hood IP65 + Semi Circular Base
Material	Aluminium & PC
LED chips	14pcs SMD2835
Kelvin	3000K
Lumens	430LM
Wattage	10W
Power factor	>0.5
CRI	>80
Beam angle	116°
Dimensions	Please see the line drawing
Back plate	115x67x19mm
Carton QTY	1/8

*To avoid disappointment and warranty problems, please ensure the IP Rating of the chosen product is relevant for the intended use.

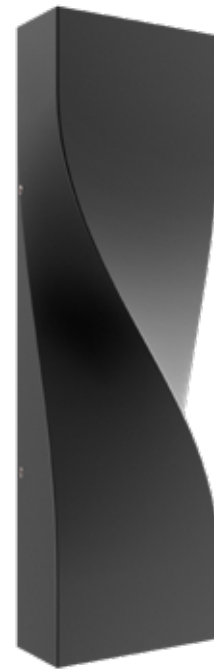

GIRO01
(Dark grey)



GIRO02
(White)

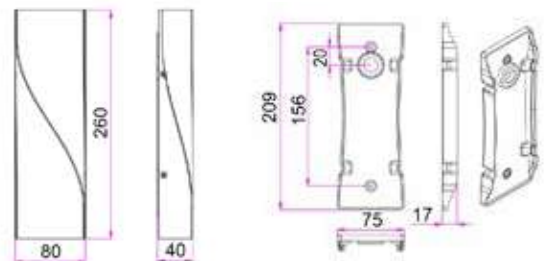

Back plate

- Exterior LED surface mounted up/down wall lights
- Input voltage: 100-240V AC 50/60Hz
- Inbuilt Constant Current driver included
- Housing & heatsink: aluminium
- Diffuser: PC
- Back plate: aluminium
- 2 stickers included which allow narrowing of beam angle at both or either end
- Beam angle: without sticker is 117° and with the sticker is 68.9°
- LED chips: 2pcs 5050
- Ambient temperature: -20 to 50°C
- Not suitable for dimming
- Suitable for 2 way switching
- Suitable for use with PIR sensor



Part No.	GIRO01, GIRO02
Description	WALL LED S/M RECT (Twisted) Up/Dn IP65 + Flush Base Adj (Stickers)
Material	Aluminium & PC
LED chips	2pcs 5050
Kelvin	3000K
Lumens	570LM
Wattage	11W
Power factor	>0.8
CRI	>80
Beam angle	117
Back plate	209x75x17mm
Carton QTY	1/12

*To avoid disappointment and warranty problems, please ensure the IP Rating of the chosen product is relevant for the intended use.

OLA & REPISA Exterior Lighting

- Exterior LED surface mounted wall lights
- Input voltage range: 100-240V AC 50/60Hz
- Inbuilt Constant Current driver included
- Housing & heatsink: aluminium
- White diffuser: UV resistant PC
- Back plate: aluminium
- Ambient temperature: -20 to 50°C
- Not suitable for dimming
- Suitable for 2 way switching
- Suitable for use with PIR sensor



Part No.	OLA01, OLA02
Description	WALL LED S/M RECT (Wavy) IP65 + RECT Base
Material	Aluminium & PC
LED chips	48pcs 2835
Kelvin	3000K
Lumens	509LM
Wattage	7W
Power factor	>0.8
CRI	>80
Back plate	130x63x31mm
Carton QTY	1/12



OLA01
(Dark grey)



OLA02
(White)

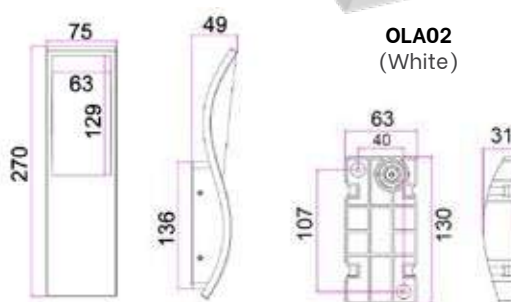

Part No.	REPISA01, REPISA02
Description	WALL LED S/M Wedge + Flush Base
Material	Aluminium & PC
LED chips	16pcs 2835
Kelvin	3000K
Lumens	910LM
Wattage	13W
Power factor	>0.9
CRI	>80
Back plate	225x77x17mm
Carton QTY	1/8



REPISA01
(Dark grey)



REPISA02
(White)

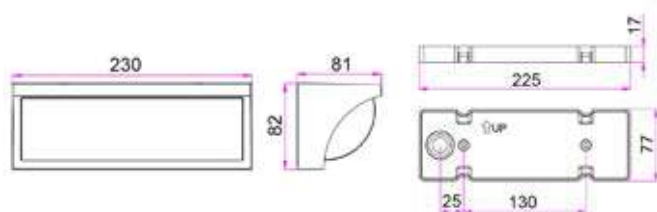

Back plate

*To avoid disappointment and warranty problems, please ensure the IP Rating of the chosen product is relevant for the intended use.

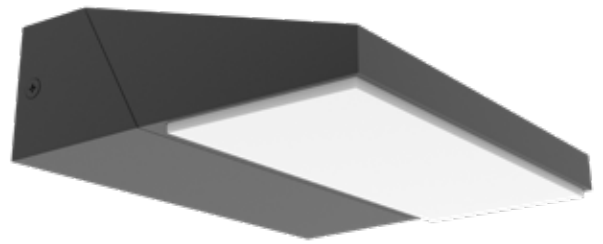

PLANA01
(Dark grey)

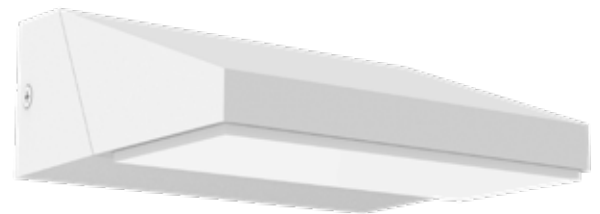

PLANA02
(White)



* Degree of Swivel: 180°

- Exterior LED adjustable surface mounted wall lights
- Input voltage: 100-240V AC 50/60Hz
- Inbuilt Constant Current driver included
- Housing & heatsink: aluminium
- Diffuser: UV resistant PC
- Back plate: aluminium
- Degree of Swivel: 180°
- LED chips: 12pcs 2835
- Ambient temperature: -20 to 50°C
- Not suitable for dimming
- Suitable for 2 way switching
- Suitable for use with PIR sensor



Part No.	PLANA01, PLANA02
Description	WALL LED S/M Wedge Swivel IP65 + RECT Base
Material	Aluminium & PC
LED chips	12pcs 2835
Kelvin	3000K
Lumens	650LM
Wattage	13W
Power factor	>0.9
CRI	>80
Beam angle	127°
Back plate	166x44x27mm
Carton QTY	1/8

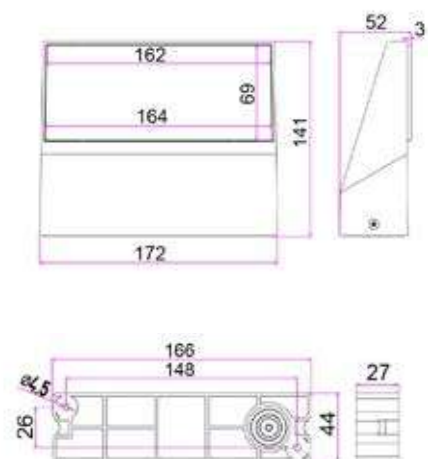

Back plate

*To avoid disappointment and warranty problems, please ensure the IP Rating of the chosen product is relevant for the intended use.

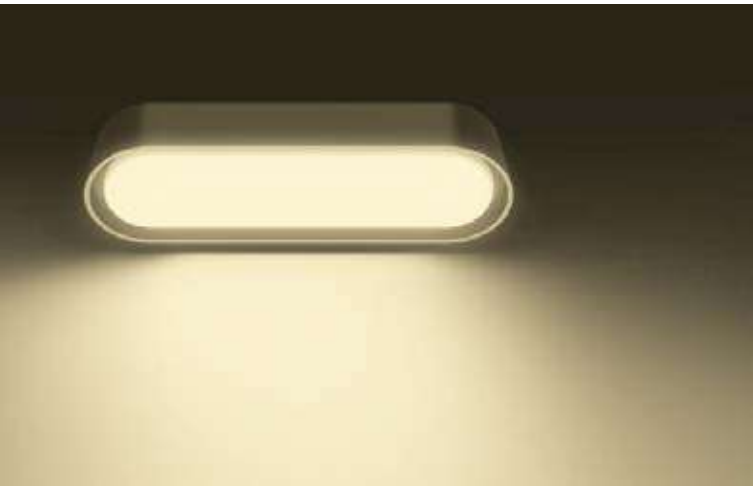

GLANS01 & GLANS03
(Dark grey)



GLANS02 & GLANS04
(White)

- Exterior LED surface mounted wall lights
- Input voltage range: 100-240V AC 50/60Hz
- Output voltage: 13.5-22V
- Housing & heat sink: aluminium
- Mounting bracket & diffuser: PC
- LED chips: 6pcs or 12pcs 3030 LED
- Power factor: >0.5
- Ambient temperature: -20 to 50°C
- Not suitable for dimming
- Suitable for 2-way switching
- Suitable for use with PIR or Microwave sensors

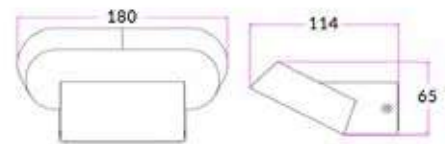

GLANS01-02

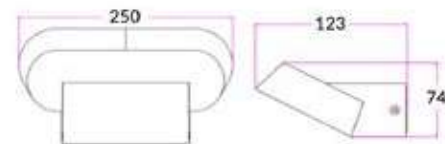

GLANS03-04



Part No.	Description	Kelvin	Lumens	Watt	CRI	LED Chips	Beam Angle	Dimensions	Carton QTY
GLANS01	WALL LED Dark Grey 7W	3000K	180LM	7	80	6pcs 3030	111.6°	180x65x114mm	1/8
GLANS02	WALL LED White 7W	3000K	180LM	7	80	6pcs 3030	111.6°	180x65x114mm	1/8
GLANS03	WALL LED Dark Grey 13W	3000K	330LM	13	80	12pcs 3030	112.3°	250x74x123mm	1/8
GLANS04	WALL LED White 13W	3000K	330LM	13	80	12pcs 3030	112.3°	250x74x123mm	1/8

*To avoid disappointment and warranty problems, please ensure the IP Rating of the chosen product is relevant for the intended use.

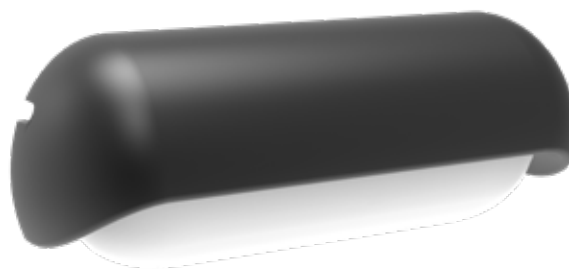

AKEN1
(Dark grey)



AKEN2
(White)

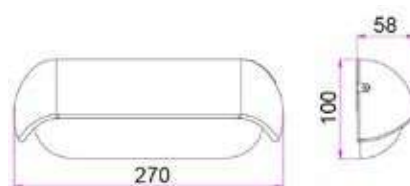

Back plate

- Exterior LED surface mounted eyelid wall lights
- Input voltage range: 100–240V AC 50/60Hz
- Inbuilt Constant Current driver included
- Housing & heat sink: aluminium
- Diffuser & back plate: PC
- LED chips: 12pcs 3030 LED
- Power factor: >0.5
- Ambient temperature: -20 to 50°C
- Not suitable for dimming
- Suitable for 2-way switching
- Suitable for use with PIR or Microwave sensors



Part No.	AKEN1, AKEN2
Description	WALL LED S/M RECT (RND) Eyelid IP65 + Flush Base
Material	Aluminium & PC
LED chips	12pcs 3030
Kelvin	3000K
Lumens	960LM
Wattage	13W
Power factor	>0.5
CRI	>80
Beam angle	120°
Dimensions	L 270 x H 100 x D 58mm
Back plate	270x100mm
Carton QTY	1/8

*To avoid disappointment and warranty problems, please ensure the IP Rating of the chosen product is relevant for the intended use.

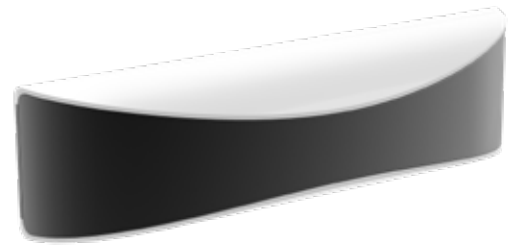

APIS1
(Dark grey)

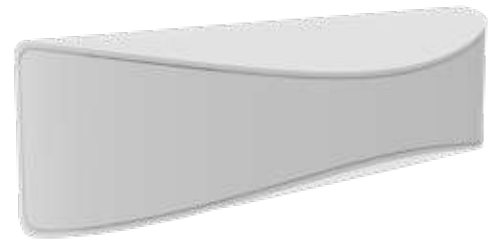

APIS2
(White)

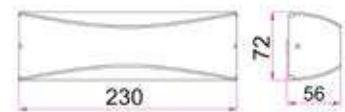

- Exterior LED surface mounted up/down wall lights
- Input voltage range: 220-240V AC 50/60Hz
- Inbuilt Constant Current driver included
- Shade, diffuser & bracket: PC
- LED chips: 50pcs 2835
- Power factor: 0.5
- Ambient temperature: -20 to 50°C
- Not suitable for dimming
- Suitable for 2-way switching
- Suitable for use with PIR or Microwave sensors



Part No.	APIS1, APIS2
Description	WALL LED S/M Crescent (Reverse) Up/Dn IP65 + Flush Base 10W 120D 3K
Material	PC
LED chips	50pcs 2835
Kelvin	3000K
Lumens	275.75LM
Wattage	10W
Power factor	0.5
CRI	>80
Beam angle	120°
Dimensions	L 230 x W 72 x D 56mm
Back plate	230x72mm
Carton QTY	1/8

*To avoid disappointment and warranty problems, please ensure the IP Rating of the chosen product is relevant for the intended use.



ATEN1
(Matte black)

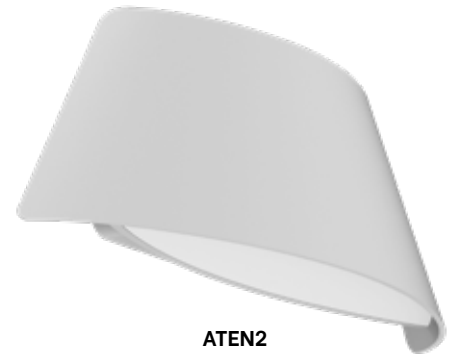

ATEN2
(Matte white)

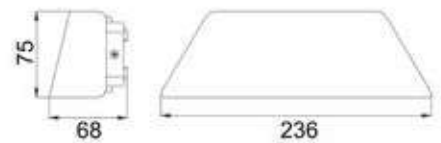

- Exterior LED surface mounted up/down lights
- Input voltage range: 100-240V AC 50/60Hz
- Housing: aluminium
- Diffuser: PC
- Ambient temperature: -20 to 50°C
- Not suitable for use with dimmers
- Suitable for 2-way switching
- Suitable for use with PIR or Microwave sensors



Part No.	ATEN1, ATEN2
Description	WALL LED S/M Curved Up/Dn IP65 M/BLK + FLUSH Base 9W
Material	Aluminium & PC
LED chips	8pcs 3030
Kelvin	3000K
Lumens	531LM
Wattage	9W
Power factor	>0.5
CRI	>80
Beam angle	120°
Dimensions	L 236 x W 75 x D 68mm
Back plate	135x50x8mm
Carton QTY	1/9

**To avoid disappointment and warranty problems, please ensure the IP Rating of the chosen product is relevant for the intended use.*



MARINA1
(Dark grey)

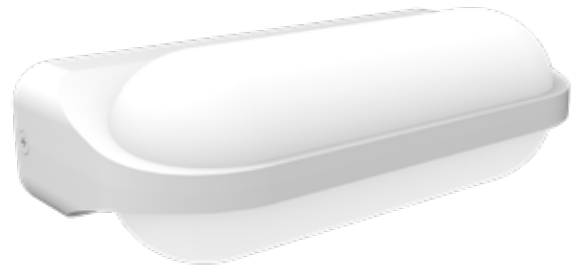

MARINA2
(White)

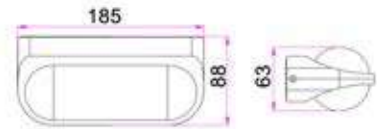

- Exterior LED surface mounted up/down wall lights
- Input voltage range: 100-240V AC 50/60Hz
- Output voltage range: 13.5-22V DC
- Housing: aluminium
- Diffuser & bracket: PC
- Ambient temperature: -20 to 50°C
- Not suitable for dimming
- Suitable for 2-way switching
- Suitable for use with PIR & Microwave sensors



Part No.	MARINA1, MARINA2
Description	WALL LED S/M Oval Up/Dn IP65 + Flush Base
Material	Aluminium & PC
LED chips	6pcs 3030
Kelvin	3000K
Lumens	380LM
Wattage	7W
Power factor	>0.5
CRI	80
Beam angle	173°
Dimensions	L 185 x W 63 x D 88mm
Back plate	92.5x50.5mm
Carton QTY	1/8

**To avoid disappointment and warranty problems, please ensure the IP Rating of the chosen product is relevant for the intended use.*

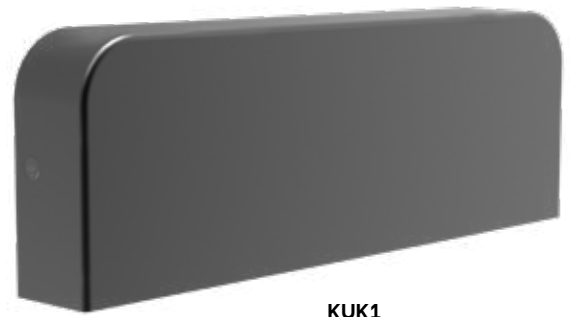

KUK1
(Dark grey)

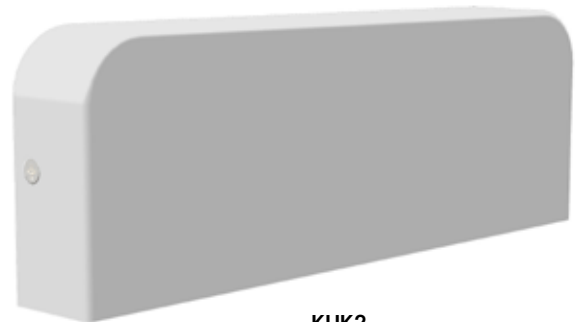

KUK2
(White)

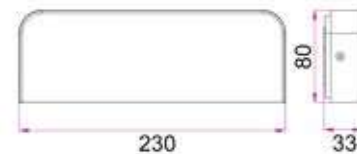

- Exterior LED surface mounted wall lights
- Input voltage range: 100-240V 50/60Hz
- Shade & heatsink: aluminium
- Diffuser & bracket: PC
- Shade internal colour: white
- LED chips: 50pcs 2835
- Ambient temperature: -20 to 50°C
- Not suitable for dimming
- Suitable for 2 way switching
- Suitable for use with PIR or Microwave sensors



Part No.	KUK1, KUK2
Description	WALL LED S/M RECT (RND) IP54 + Flush Base
Material	Aluminium & PC
LED chips	50pcs 2835
Kelvin	3000K
Lumens	670LM
Wattage	10W
Power factor	>0.5
CRI	>80
Beam angle	120°
Dimensions	L 230 x W 80 x D 33mm
Back plate	220x70mm
Carton QTY	1/12

**Unless protected, not recommended for environments with harsh weather conditions or heavy rainfall. IP65 fittings recommended for such environments.*

**To avoid disappointment and warranty problems, please ensure the IP Rating of the chosen product is relevant for the intended use.*

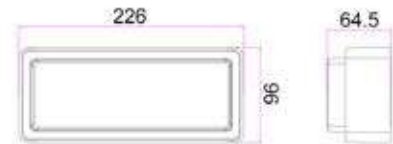
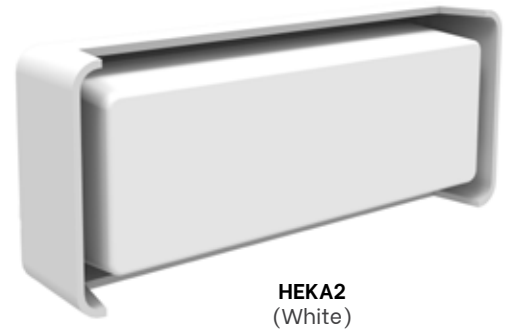

- Exterior LED surface mounted wall lights
- Input voltage range: 100-240V AC 50/60Hz
- Inbuilt constant current driver included
- Housing & heatsink: aluminium
- Diffuser: PC
- Back plate: PC
- Ambient temperature: -20 to 50°C
- Not suitable for dimming
- Suitable for 2-way switching
- Suitable for use with PIR or Microwave sensors



Part No.	HEKA1, HEKA2
Description	WALL LED S/M RECT 3 Way IP65 + Flush Base
Material	Powder coated aluminium & PC
LED chips	12pcs 3030
Kelvin	3000K
Lumens	732.94LM
Wattage	13W
Power factor	>0.5
CRI	>80
Beam angle	120°
Dimensions	L 226 x W 96 x D 64.5mm
Back plate	197x65mm
Carton QTY	1/8

**To avoid disappointment and warranty problems, please ensure the IP Rating of the chosen product is relevant for the intended use.*

TOPA Exterior Lighting

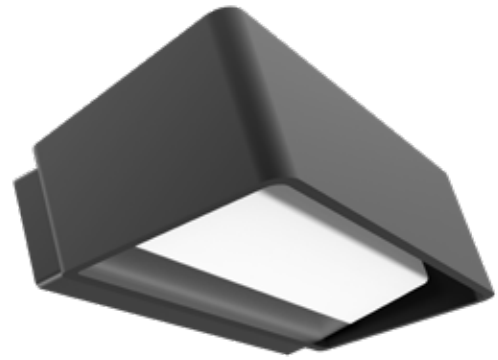

TOPA0001
(Dark grey)

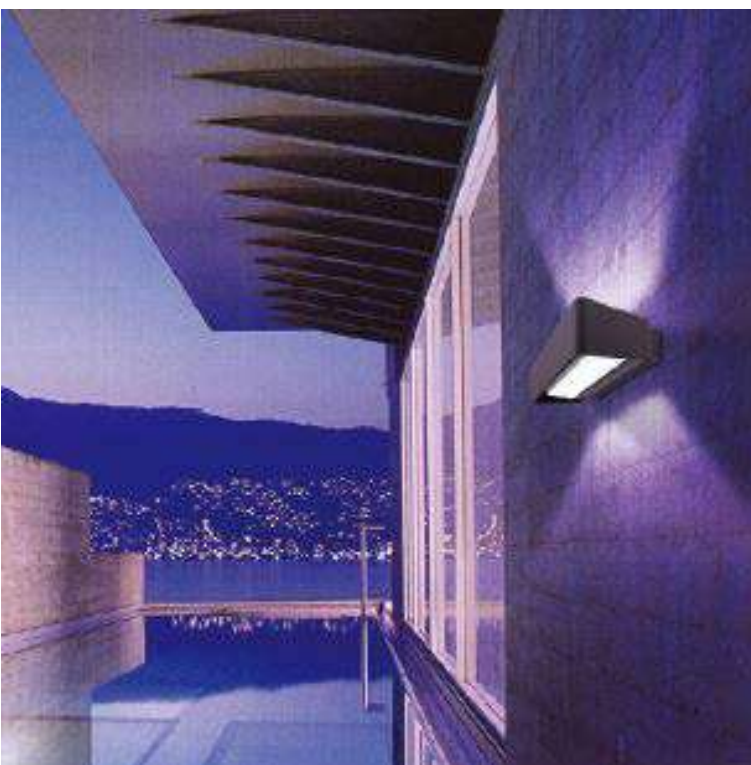

TOPA0002
(White)



- Exterior LED surface mounted up/down wall lights
- Input voltage range: 100-240V AC 50/60Hz
- Inbuilt constant current driver included
- Housing & heatsink: aluminium
- Diffuser & bracket: PC
- Ambient temperature: -20 to 50°C
- Not suitable for dimming
- Suitable for 2-way switching
- Suitable for use with PIR or Microwave sensors



Part No.	TOPA0001, TOPA0002
Description	WALL LED S/M RECT (RND) Up/Dn IP65 + RECT Base
Material	Aluminium & PC
LED chips	12pcs 3030
Kelvin	3000K
Lumens	600LM
Wattage	13W
Power factor	>0.5
CRI	>80
Beam angle	304°
Dimensions	L 248 x W 70 x D 117mm
Carton QTY	1/12

*To avoid disappointment and warranty problems, please ensure the IP Rating of the chosen product is relevant for the intended use.

TAMA Exterior Lighting

- Exterior LED surface mounted up/down wall lights
- Input voltage range: 220-240V AC 50/60Hz
- Output voltage range: 13-24V DC
- Shade & bracket: aluminium
- Diffuser: PC
- Ambient temperature: -20 to 50°C
- Not suitable for dimming
- Suitable for 2-way switching
- Suitable for use with PIR & Microwave sensors



Part No.	TAMA1, TAMA2
Description	WALL LED S/M RECT (RND) Up/Dn IP54 + Flush Base
Material	Aluminium & PC
LED chips	18pcs 2835
Kelvin	3000K
Lumens	605LM
Wattage	6.8W
Power factor	>0.5
CRI	80
Back plate	92.5x50.5mm
Carton QTY	1/24

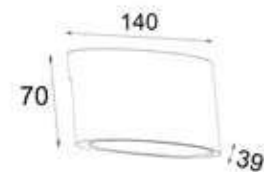

REMO Exterior Lighting

- Exterior LED surface mounted up/down wall lights
- Input voltage range: 220-240V AC 50/60Hz
- Output voltage range: 13-24V DC
- Shade & bracket: aluminium
- Diffuser: PC
- Ambient temperature: -20 to 50°C
- Not suitable for dimming
- Suitable for 2-way switching
- Suitable for use with PIR & Microwave sensors



Part No.	REMO1, REMO2
Description	WALL LED S/M RECT (RND) Up/Dn IP54 + Flush Base
Material	Aluminium & PC
LED chips	18pcs 2835
Kelvin	3000K
Lumens	500LM
Wattage	6.8W
Power factor	>0.5
CRI	80
Back plate	84x51mm
Carton QTY	1/24

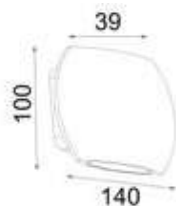

*Unless protected, not recommended for environments with harsh weather conditions or heavy rainfall. IP65 fittings recommended for such environments. To avoid disappointment and warranty problems, please ensure the IP Rating of the chosen product is relevant for the intended use.



BES1
(Dark grey)



BES2
(White)

- Exterior LED surface mounted up/down wall lights
- Input voltage range: 100-240V AC 50/60Hz
- Housing: aluminium
- Diffuser: glass
- Back plate: PC
- Ambient temperature: -20 to 50°C
- Not suitable for use with dimmers
- Suitable for 2-way switching
- Suitable for use with PIR or Microwave sensors



Height: 174mm
 Width of the TOP: 77mm
 Depth of the TOP: 35mm
 Width of the BOTTOM: 106mm
 Depth of the BOTTOM: 51mm

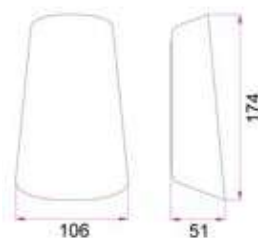

Part No.	BES1, BES2
Description	WALL LED S/M Curved Up/Dn IP65 + Flush Base
Material	Aluminium, PC & glass
LED chips	2pcs 5050
Kelvin	3000K
Lumens	368LM
Wattage	11W
Power factor	>0.5
CRI	>80
Beam angle	120°
Dimensions	L 174 x W 106 x D 51mm
Carton QTY	1/18

*To avoid disappointment and warranty problems, please ensure the IP Rating of the chosen product is relevant for the intended use.



WIG1
(Dark grey)



WIG2
(White)

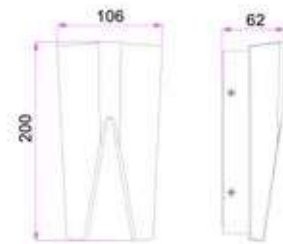

- Exterior LED surface mounted up/down wall lights
- Input voltage range: 100-240V AC 50/60Hz
- Output voltage range: 18-42V DC
- Housing: powder coated aluminium
- Bracket: PC
- 2 stickers included which allow narrowing of beam angle at both or either end
- Beam angle: without sticker is 69.9° and with the sticker is 32.7°
- Ambient temperature: -20 to 50°C
- Not suitable for dimming
- Suitable for 2-way switching
- Suitable for use with PIR or Microwave sensors



Part No.	WIG1, WIG2
Description	WALL LED S/M Wedge Up/Dn IP65 + Flush Base
Material	Aluminium
LED chips	2pcs 5050
Kelvin	3000K
Lumens	550LM
Wattage	11W
Power factor	>0.5
CRI	80
Beam angle	without sticker is 69.9° and with the sticker is 32.7°
Dimensions	200 x 106mm
Carton QTY	1/8

*To avoid disappointment and warranty problems, please ensure the IP Rating of the chosen product is relevant for the intended use.

VOX Exterior Lighting

- Exterior LED surface mounted up/down wall lights
- Input voltage range: 100-240V AC 50/60Hz
- Output voltage range: 5.5-30V
- Housing: aluminium
- Bracket: aluminium
- Ambient temperature: -20 to 45°C
- Not suitable for dimming
- Suitable for 2-way switching
- Suitable for use with PIR & Microwave sensors



Part No.	VOX1, VOX2, VOX3
Description	WALL LED S/M Squirrel Up/Dn IP54+ Flush Base
Material	Aluminium
LED chips	32pcs SMD2835
Kelvin	3000K
Lumens	VOX1-2: 808LM; VOX3: 737LM
Wattage	9W
Power factor	>0.5
CRI	80
Beam angle	120°
Dimensions	L 130 x W 130 x D 30mm
Back plate	130x130mm
Carton QTY	1/8

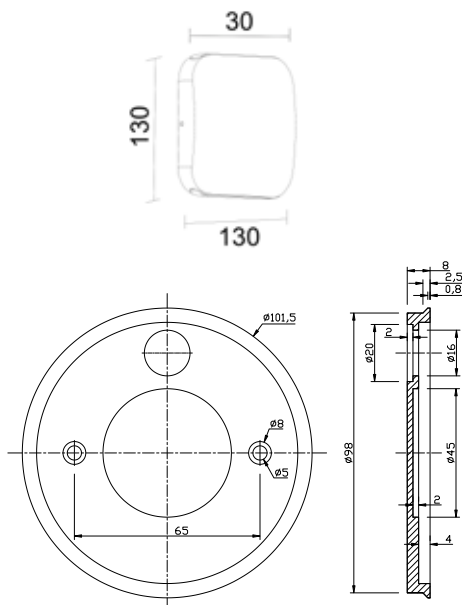

Back plate line drawing



VOX1
(Black)



VOX2
(White)



VOX3
(Polished aluminium)

*Unless protected, not recommended for environments with harsh weather conditions or heavy rainfall. IP65 fittings recommended for such environments.

*To avoid disappointment and warranty problems, please ensure the IP Rating of the chosen product is relevant for the intended use.



TOCA1
(Black)



TOCA2
(White)

- Exterior LED surface mounted up/down wall lights
- With adjustable beam angle
- Input voltage range: 220-240V AC 50/60Hz
- Output voltage range: 13-24V DC
- Material: aluminium
- LED chips: 18pcs SMD2835
- Ambient temperature: -20 to 50°C
- Not suitable for dimming
- Suitable for 2-way switching
- Suitable for use with PIR & Microwave sensors



Part No.	TOCA1, TOCA2
Description	WALL LED S/M Cube Up/Dn with Adjustable Lens Covers IP54 + Flush Base
Material	Aluminium
LED chips	18pcs SMD2835
Kelvin	3000K
Lumens	408LM
Wattage	6.8W
Power factor	≥0.5
CRI	80
Dimensions	L 100 x W 100 x D 100mm
Carton QTY	1/12

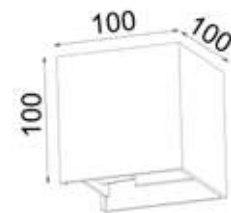

Adjustable beam angle:



*Unless protected, not recommended for environments with harsh weather conditions or heavy rainfall. IP55 fittings recommended for such environments.

*To avoid disappointment and warranty problems, please ensure the IP Rating of the chosen product is relevant for the intended use.



TOCA3
(Matte black)



TOCA4
(Matte white)



- Exterior LED surface mounted up/down lights
- With adjustable lens covers
- Input voltage range: 200-240V
- Inbuilt driver
- Housing: powder coated aluminium
- Diffuser: frosted glass
- Mounting plate: aluminium
- LED chips: 2pcs COB
- Ambient temperature: -20 to 50°C
- Not suitable for dimming
- Suitable for 2-way switching
- Suitable for use with Microwave or PIR sensors



Part No.	TOCA3, TOCA4
Description	WALL LED S/M Cube Up/Dn with Adjustable Lens Covers IP65 + Flush Base
Material	Aluminium & glass
LED chips	2pcs COB
Kelvin	3000K
Lumens	940LM
Wattage	20W
Power factor	0.9
CRI	80
Beam angle	120°
Dimensions	L 150 x W 150 x D 100mm
Back plate	W 130 x H 110mm
Carton QTY	1/6

*To avoid disappointment and warranty problems, please ensure the IP Rating of the chosen product is relevant for the intended use.

WEDGE Exterior Lighting



WEDGEBL
(SS 316 powder coated black)



WEDGEC
(Copper)



WEDGESS
(SS 316)



WEDGEWH
(SS 316 powder coated white)



- Exterior surface mounted wall wedge lights
- Input voltage range: 110-265V AC 50/60Hz
- Material: 316 stainless steel, copper
- Lamp holder: GU10 (Max. 35W)
- Globes not included



Part No.	WEDGEBL, WEDGEC, WEDGESS, WEDGEWH
Description	WALL S/M Wedge IP44 + Flush Base
Material	SS 316 / Copper
Lamp holder	1xGU10 (Max.35W)
Dimensions	L 143 x W 70 x D 75mm
Back plate	143x70mm
Carton QTY	1/20

**Unless protected, not recommended for environments with harsh weather conditions or heavy rainfall. IP65 fittings recommended for such environments.*

**To avoid disappointment and warranty problems, please ensure the IP Rating of the chosen product is relevant for the intended use.*

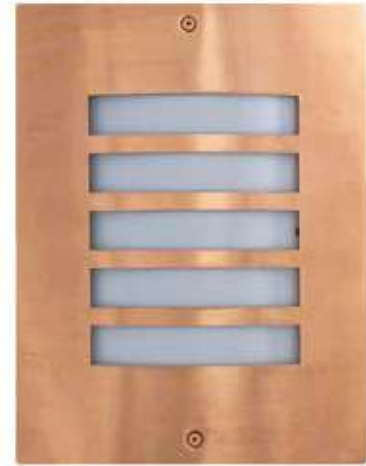

NED01
(Solid Copper)



NED02
(316 Stainless steel)

- Exterior surface mounted wall lights
- Input voltage range: 110-265V AC 50/60Hz
- Faceplate: 316 stainless steel or solid copper
- Housing & Diffuser: PC
- Lamp holder: 1xE27 (Max.60W)
- Globes not included



Part No.	NED01, NED02
Description	WALL ES 60W S/M RECT with Grill IP54 + Flush Base
Material	Faceplate: Copper/ 316 SS Housing & diffuser: PC
Lamp holder	1xE27 (Max.60W)
Dimensions	W 220 x L 280mm
Carton QTY	1/10

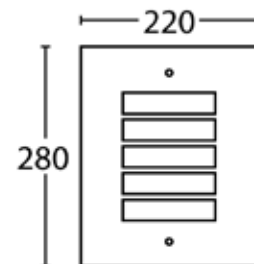

**Unless protected, not recommended for environments with harsh weather conditions or heavy rainfall. IP65 fittings recommended for such environments.*

**To avoid disappointment and warranty problems, please ensure the IP Rating of the chosen product is relevant for the intended use.*

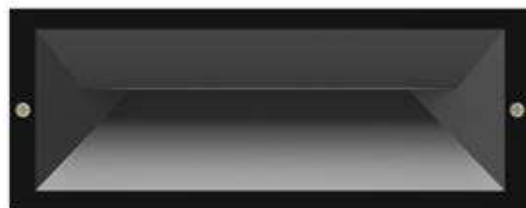

BRICK0001
(Dark grey)



BRICK0002
(White)



BRICK0003
(Dark grey)

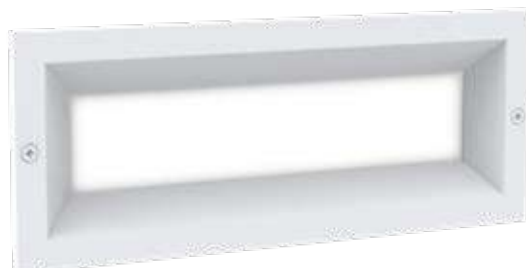

BRICK0004
(White)

- Exterior LED recessed wall lights
- Input voltage range: 100-240V AC 50/60Hz
- Internal constant current driver included
- Housing & heatsink: aluminium
- Sleeve & diffuser: PC
- LED chips: 12pcs 3030
- Beam angle: please see below
- Ambient temperature: -20 to 50°C
- Not suitable for dimming
- Suitable for 2 way switching
- Suitable for use with PIR or Microwave sensors



Part No.	BRICK0001-0004
Description	BRICK0001-0002: WALL LED RECD RECT Eyelid IP65 + Sleeve BRICK0003-0004: WALL LED RECD RECT IP65 + Sleeve
Material	Aluminium & PC
LED chips	12pcs 3030
Kelvin	3000K
Lumens	BRICK0001-0002: 279LM BRICK0003-0004: 546LM
Wattage	13W
Power factor	>0.5
CRI	>80
Beam angle	BRICK0001-0002: 60° BRICK0003-0004: 100°
Dimensions	L250 x W98 x D90mm
Cut out	L227 x W76 x D78mm
Carton QTY	1/8

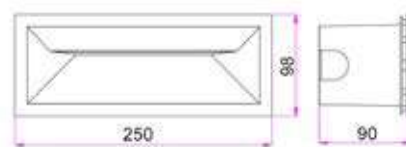

Sleeve line drawing

*To avoid disappointment and warranty problems, please ensure the IP Rating of the chosen product is relevant for the intended use.

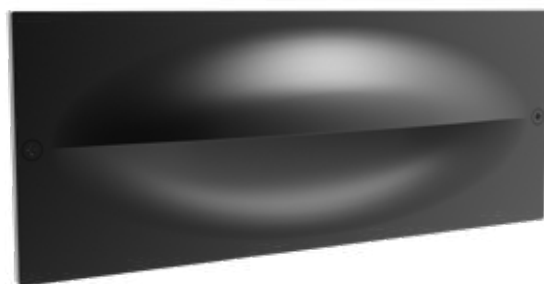
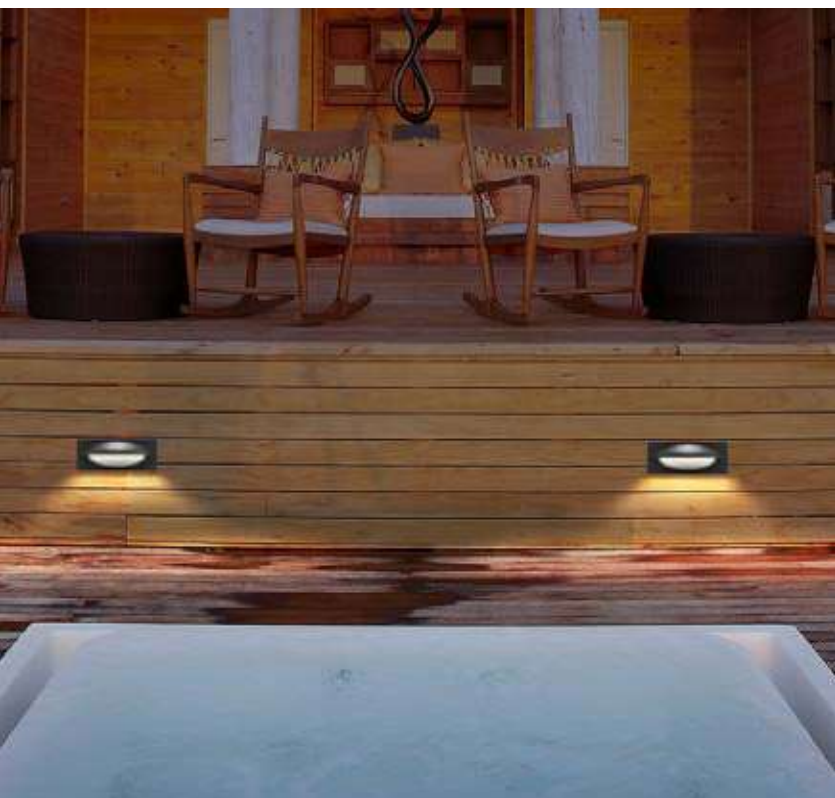

OGA01
(Dark grey)

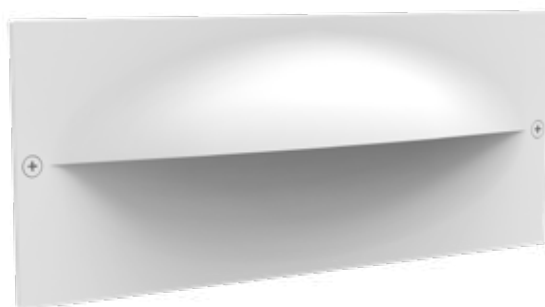

OGA02
(White)

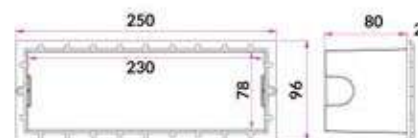
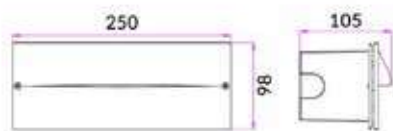

Sleeve line drawing

- Exterior LED recessed wall lights
- Input voltage range: 100-240V AC50/60Hz
- Internal constant current driver included
- Housing & heatsink: aluminium
- Bracket: PC
- LED chips: 12pcs 3030 LED
- Power factor: >0.5
- Ambient temperature: -20 to 50°C
- Not suitable for dimming
- Suitable for 2 way switching
- Suitable for use with PIR or Microwave sensors



Part No.	OGA01, OGA02
Description	WALL LED RECT Eyelid IP65 + Sleeve
Material	Aluminium
Kelvin	3000K
Lumens	380LM
Wattage	13W
LED Chips	12pcs 3030
Power factor	>0.5
CRI	>80
Dimensions	L 250 x W 98 x D 105mm
Cut out	230x78mm
Carton QTY	1/8

*To avoid disappointment and warranty problems, please ensure the IP Rating of the chosen product is relevant for the intended use.

BULK1-8 Exterior Lighting



BULK1



BULK2

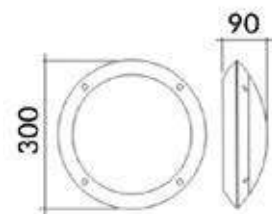

- Exterior LED bulkhead lights
- Input voltage range: 220-240V AC 50/60Hz
- Housing: polycarbonate
- Frosted diffuser & back plate: PC
- LED chips: 63pcs SMD2835
- Ambient temperature: -20 to 45°C
- Double insulated
- IK10 impact rating for Vandal resistance
- Large terminal holes for easy connection
- Not suitable for dimming
- Suitable for 2 way switching
- Suitable for use with PIR or Microwave sensors

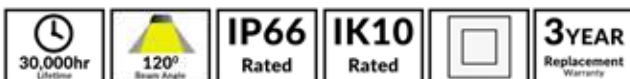

Part No.	BULK1, BULK2
Description	BULKHEAD/ WALL LED AC RND IP66 IK10 + Flush Base
Material	Polycarbonate
Kelvin	4000K
Lumens	800LM
Wattage	12W
LED Chips	63pcs SMD2835
Power factor	≥0.5
CRI	>80
Dimensions	Ø300 x D 90mm
Carton QTY	1/8

**To avoid disappointment and warranty problems, please ensure the IP Rating of the chosen product is relevant for the intended use.*

Part No.	BULK3
Description	BULKHEAD/ WALL LED AC Oval IP66 IK10 BLK + Flush Base
Material	Polycarbonate
Kelvin	4000K
Lumens	800LM
Wattage	12W
LED Chips	63pcs SMD2835
Power factor	≥0.5
CRI	>80
Dimensions	W 230 x L 330 x D 90mm
Carton QTY	1/8



BULK3



BULK7

Part No.	BULK5
Description	BULKHEAD/ WALL LED AC Squircle IP66 IK10 + Flush Base
Material	Polycarbonate
Kelvin	4000K
Lumens	800LM
Wattage	12W
LED Chips	63pcs SMD2835
Power factor	≥0.5
CRI	>80
Dimensions	W 280 x L 280 x D 90mm
Carton QTY	1/8



BULK5

Part No.	BULK7
Description	BULKHEAD/ WALL LED AC RND Eyelid IP66 IK10 + Flush Base
Material	Polycarbonate
Kelvin	4000K
Lumens	500LM
Wattage	12W
LED Chips	63pcs SMD2835
Power factor	≥0.5
CRI	>80
Dimensions	Ø300 x D 90mm
Carton QTY	1/8

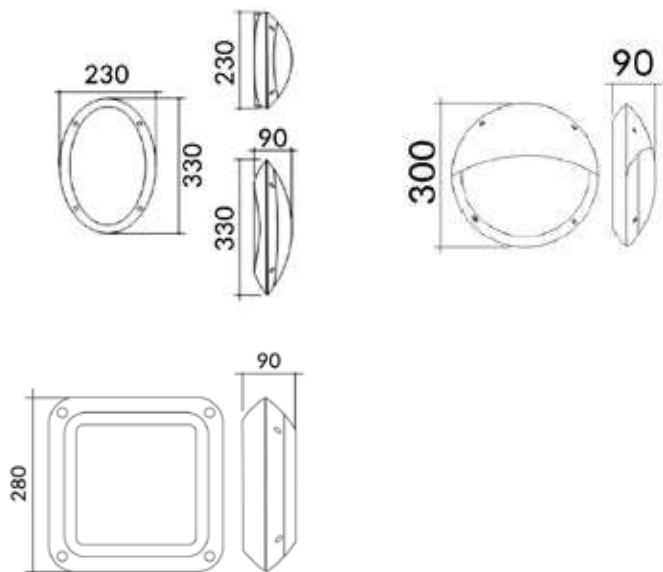

*To avoid disappointment and warranty problems, please ensure the IP Rating of the chosen product is relevant for the intended use.

BULK9-10 Exterior Lighting

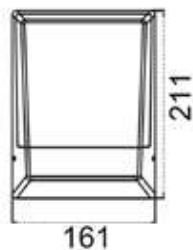

BULK9



BULK10

- Exterior LED bulkhead letter box lights
- Input voltage range: 100-240V AC 50-60Hz
- Internal LED driver
- Shade: aluminium
- Diffuser & back plate: PC
- LED chips: SMD2835
- Power factor: >0.5
- Ambient temperature: -20 to 45°C
- IK10 impact rating for Vandal resistance
- The number stickers are included in the packaging



Part No.	BULK9, BULK10
Description	BULKHEAD / WALL / Letterbox RECT Eyelid IP65 IK10 + Flush Base
Material	Die cast aluminium & PC
Kelvin	3000K
Lumens	770LM
Wattage	12W
LED Chips	SMD2835
Power factor	>0.5
CRI	>80
Dimensions	W 161 x L 211 x D 60mm
Carton QTY	1/12

**To avoid disappointment and warranty problems, please ensure the IP Rating of the chosen product is relevant for the intended use.*

BULK11-14 Exterior Lighting



BULK11 & 12



BULK13 & 14



**Optional cage/guard removed*

- Exterior LED bulkhead lights
- Input voltage range: 190-250V AC 50/60Hz
- Inbuilt LED driver included
- Housing: PC
- Frosted diffuser: PC
- Screw & mounting bracket: iron
- LED chips: 45pcs 2835
- Power factor: ≥ 0.9
- Ambient temperature: -20 to 40°C
- Not suitable for dimming
- Suitable for 2 way switching
- Suitable for use with PIR and Microwave sensor
- Optional cage/guard included

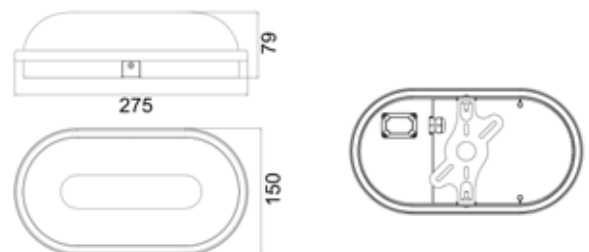

Part No.	Description	Kelvin	Lumens	Watt	CRI	Power Factor	Dimensions	Carton QTY
BULK11	BULKHEAD / WALL LED BLK OVAL (with optional cage)	3000K	1600LM	20W	80	≥ 0.9	275x150x79mm	1/8
BULK12	BULKHEAD / WALL LED BLK OVAL (with optional cage)	5000K	1700LM	20W	80	≥ 0.9	275x150x79mm	1/8
BULK13	BULKHEAD / WALL LED WH OVAL (with optional cage)	3000K	1600LM	20W	80	≥ 0.9	275x150x79mm	1/8
BULK14	BULKHEAD / WALL LED WH OVAL (with optional cage)	5000K	1700LM	20W	80	≥ 0.9	275x150x79mm	1/8

**To avoid disappointment and warranty problems, please ensure the IP Rating of the chosen product is relevant for the intended use.*

BULK15-18 Exterior Lighting



BULK15 & 17



BULK16 & 18



Rear



- Exterior LED Eyelid bulkhead lights
- Input voltage range: 180-250V AC 50/60Hz
- Inbuilt constant current driver included
- Material: PC
- Bracket: iron
- Flex: 150mm
- LED chips: 30pcs 2835
- Power factor: ≥ 0.9
- Ambient temperature: -20 to 40°C
- Not suitable for use with dimmers
- Suitable for 2-way switching
- Suitable for use with PIR or Microwave sensors

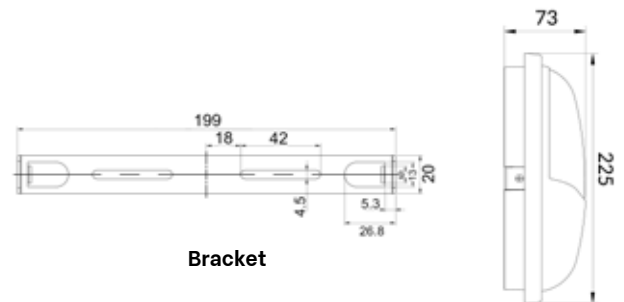

Bracket



Part No.	Description	Kelvin	Lumens	Watt	CRI	Power Factor	Dimensions	Carton QTY
BULK15	BULKHEAD / WALL LED BLK RND Eyelid	3000K	1600LM	20W	80	≥ 0.9	$\varnothing 225 \times 73 \text{mm}$	1/10
BULK16	BULKHEAD / WALL LED WH RND Eyelid	3000K	1600LM	20W	80	≥ 0.9	$\varnothing 225 \times 73 \text{mm}$	1/10
BULK17	BULKHEAD / WALL LED BLK RND Eyelid	5000K	1600LM	20W	80	≥ 0.9	$\varnothing 225 \times 73 \text{mm}$	1/10
BULK18	BULKHEAD / WALL LED WH RND Eyelid	5000K	1600LM	20W	80	≥ 0.9	$\varnothing 225 \times 73 \text{mm}$	1/10

*To avoid disappointment and warranty problems, please ensure the IP Rating of the chosen product is relevant for the intended use.

LED BULKHEAD LIGHTS

Exterior Lighting

- Exterior LED bulkhead light
- Input voltage range: 220-240V AC
- Housing: powder coated aluminium
- Diffuser: clear PC
- Mounting plate & heatsink: aluminium
- LED chip: 1pc COB
- Power factor: 0.9
- CRI: ≥ 70
- Flex: 0.6m
- Ambient temperature: -20 to 45°C
- Not suitable for dimming
- Suitable for 2 way switching
- Suitable for use with PIR or Microwave sensors



CLA4736CB

Part No.	CLA4736CB
Description	BULKHEAD / WALL LED AC RECT Eyelid IP65 IK10 BLK + Flush Base
Material	Aluminium & PC
Kelvin	5000K
Lumens	1900LM
Wattage	20W
LED Chips	1PC COB
Power factor	0.9
CRI	≥ 70
Dimensions	L 310 x W 265 x D 180mm
Mounting plate	L 300 x W 265mm
Carton QTY	1/1



*Flex: 0.6m

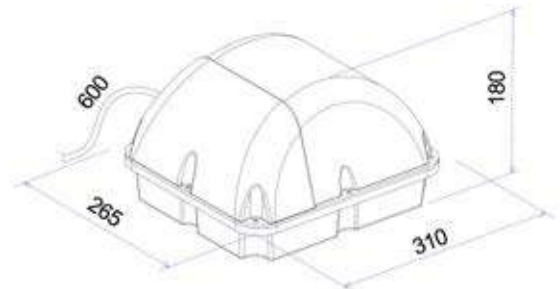

*To avoid disappointment and warranty problems, please ensure the IP Rating of the chosen product is relevant for the intended use.



ULAN1
(Dark grey)



ULAN2
(White)



*Onboard inbuilt driver

Back plate

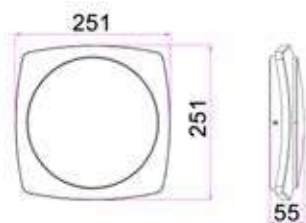

- Exterior LED wall/ceiling lights
- Input voltage range: 220-240V AC 50/60Hz
- Output voltage range: 225-245V
- Housing: powder coated aluminium
- Diffuser: PC
- Bracket: PC
- LED chip: 25pcs 2835
- Power factor: >0.9
- Ambient temperature: -20 to 50°C
- Suitable for 2-way switching
- Suitable for use with PIR or Microwave sensors



Part No.	ULAN1, ULAN2
Description	WALL / CEILING LED S/M Squirrel IP65 + Flush Base
Material	Powder coated aluminium & PC
Kelvin	3000K
Lumens	980LM
Wattage	20W
LED Chips	25pcs 2835
Power factor	>0.9
CRI	80
Dimensions	251 x 251 x 55mm
Carton QTY	1/4

*To avoid disappointment and warranty problems, please ensure the IP Rating of the chosen product is relevant for the intended use.

DOCCIA Exterior Lighting



DOCCIA1
(Dark grey)



DOCCIA2
(White)

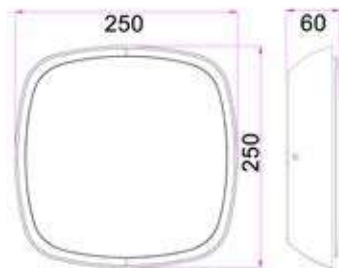

**Onboard inbuilt driver*



Back plate

- Exterior LED wall/ceiling lights
- Input voltage range: 220-240V AC 50/60Hz
- Output voltage range: 225-245V AC
- **Onboard inbuilt driver included**
- Housing: powder coated aluminium
- Diffuser: PC
- Bracket: PC
- LED chip: 28pcs 2835
- Power factor: >0.9
- Ambient temperature: -20 to 50°C
- Suitable for 2-way switching
- Suitable for use with PIR or Microwave sensors



Part No.	DOCCIA1, DOCCIA2
Description	WALL / CEILING LED S/M Squirrel IP65 + Flush Base
Material	Powder coated aluminium & PC
Kelvin	3000K
Lumens	920LM
Wattage	20W
LED Chips	28pcs 2835
Power factor	>0.9
CRI	80
Dimensions	L 250 x W 250 x D 60mm
Carton QTY	1/4

**To avoid disappointment and warranty problems, please ensure the IP Rating of the chosen product is relevant for the intended use.*



OYSDIM001-002



Tri-CCT Switch on Rear

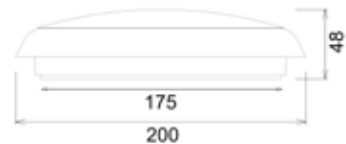

OYSDIM001

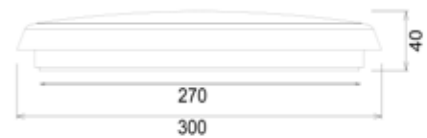

OYSDIM002

- Waterproof LED Tri-CCT dimmable oyster lights
- Input voltage range: 200-240V AC 50/60Hz
- Inbuilt driver output voltage range: 60-80V
- Material: PC
- Tri-CCT: 3000K/ 4000K/ 5000K in one fitting
- LED chips: SMD2835
- Power factor: >0.9
- CRI: 80
- Ambient temperature: -20 to 40°C
- Suitable for dimming
- Suitable for 2-way switching
- Suitable for use with PIR or microwave sensors
- Suitable for indoor & outdoor use
- Changes to appearance due to climatic conditions not covered under warranty

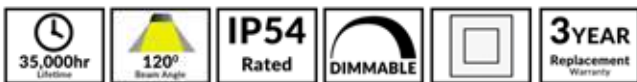

Tested & Recommended Dimmers:

Brand	Part No.
CLIPSAL	32ELEDM, 31E2PUDM, 32E450T, 31E450UDM
HPM	CAT250L

Part No.	Lumens			Watt	CRI	Diam	Depth	Back Plate	Carton QTY
	3000K	4000K	5000K						
OYSDIM001	1200LM	1300LM	1250LM	15W	80	Ø200mm	48mm	Ø175mm	1/20
OYSDIM002	2000LM	2200LM	2100LM	24W	80	Ø300mm	40mm	Ø270mm	1/12

*Unless protected, not recommended for environments with harsh weather conditions or heavy rainfall. IP65 fittings recommended for such environments.

*To avoid disappointment and warranty problems, please ensure the IP Rating of the chosen product is relevant for the intended use.

STE1-4 Exterior Lighting



STE1-2
(SS 316)



STE3-4
(Black aluminium)

- Exterior LED surface mounted eyelid step lights
- Input voltage range: 12–14V DC / 220–240V AC
- Housing: Die cast aluminium or SS 316
- Polished finish
- LED chips: 18pcs 2835
- Remote control gear required for 12V models (DC drivers only)

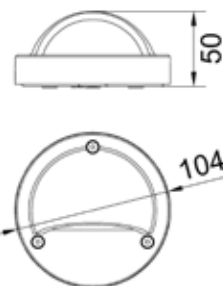

Tested & Recommended Drivers (for STE1 & 3):

CLADR12W / DRIV1 / OTTER1 / CLA111011 / CLA113011 / CLA115011 / CLA1110011 / CLA1120011 / OTTER5

Part No.	Description	Kelvin	Lumens	Watt	CRI	Power Factor	Dimensions	Back Plate	Carton QTY
STE1	STEP EYELID LED 12V DC S/M SS316 RND	3000K	144LM	1W	>70	1.0	Ø104x50mm	Ø104mm	1/30
STE2	STEP EYELID LED 240V S/M SS316 RND	3000K	144LM	1W	>70	>0.3	Ø104x50mm	Ø104mm	1/30
STE3	STEP EYELID LED 12V DC S/M BLK RND	3000K	144LM	1W	>70	1.0	Ø104x50mm	Ø104mm	1/50
STE4	STEP EYELID LED 240V S/M BLK RND	3000K	144LM	1W	>70	>0.3	Ø104x50mm	Ø104mm	1/50

**Unless protected, not recommended for environments with harsh weather conditions or heavy rainfall. IP65 fittings recommended for such environments.*

**To avoid disappointment and warranty problems, please ensure the IP Rating of the chosen product is relevant for the intended use.*

STE5-8 Exterior Lighting

- Exterior LED recessed step lights
- Input voltage range: 100-240V AC 50/60Hz
- Housing: aluminium
- Diffuser: PC
- Bracket: aluminium
- LED chips: 6pcs 3030
- Power factor: >0.5
- Ambient temperature: -20 to 50°C
- Not suitable for dimming
- Suitable for 2 way switching
- Suitable for use with PIR or Microwave sensors



*Unless protected, not recommended for environments with harsh weather conditions or heavy rainfall. IP65 fittings recommended for such environments.

*To avoid disappointment and warranty problems, please ensure the IP Rating of the chosen product is relevant for the intended use.



STE5
(Matte white)



STE6
(Matte black)

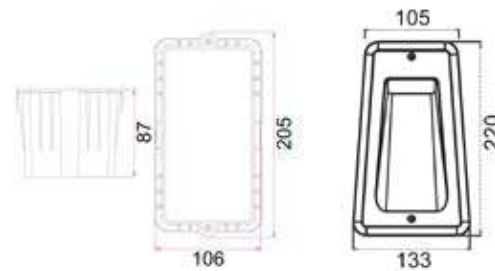

Part No.	Description	Kelvin	Lumens	Watt	CRI	Dimensions	Cut Out	Carton QTY
STE5	WALL LED RECD MATTE WH Alum Trapezium	3000K	190LM	7W	>80	133x220mm	205x106mm	1/10
STE6	WALL LED RECD MATTE BLK Alum Trapezium	3000K	190LM	7W	>80	133x220mm	205x106mm	1/10

- Exterior LED surface mounted step lights
- Input voltage range: 100-240V AC 50/60Hz
- Housing: aluminium
- Bracket: aluminium
- LED chips: 1pc XPE
- Power factor: >0.5
- Ambient temperature: -20 to 50°C
- Not suitable for dimming
- Suitable for 2 way switching
- Suitable for use with PIR or Microwave sensors



STE7
(Dark grey)



STE8
(White)

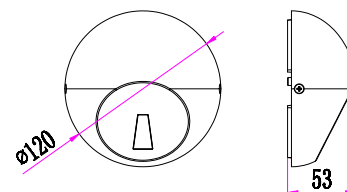

Part No.	Description	Kelvin	Lumens	Watt	CRI	Dimensions	Cut Out	Carton QTY
STE7	STEP LED 240V AC S/M Dark Grey RND	3000K	45LM	3.5W	>80	Ø120x53mm	205x106mm	1/16
STE8	STEP LED 240V AC S/M WH RND	3000K	45LM	3.5W	>80	Ø120x53mm	205x106mm	1/16

*To avoid disappointment and warranty problems, please ensure the IP Rating of the chosen product is relevant for the intended use.

STE9-10 Exterior Lighting



STE9
(Bronze)



STE10
(Brass nickel plated)

- Exterior LED surface mounted eyelid step lights
- Input voltage range: 12-14V DC 50/60Hz
- External 12V DC Constant Voltage Control Gear required
- Recommended CLA drivers: OTTER1 and CLA111011
- Material: solid bronze or solid brass
- Colours: aged bronze or nickel plated
- LED chip: 1pc XP-E-Q5
- Power factor: ≥ 0.95
- Ambient temperature: -40 to 85°C
- Not suitable for dimming

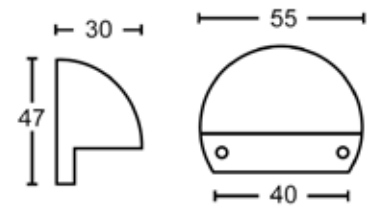

Part No.	Description	Kelvin	Lumens	Watt	CRI	Dimensions	Carton QTY
STE9	STEP EYELID LED 12V DC S/M BRONZE Aged RND	3000K	107LM	1W	80	55x30mm	1/50
STE10	STEP EYELID LED 12V DC S/M Brass Nickel Plated RND	3000K	107LM	1W	80	55x30mm	1/50

*To avoid disappointment and warranty problems, please ensure the IP Rating of the chosen product is relevant for the intended use.

STE12&23 Exterior Lighting



STE12
(Aged Bronze)



STE23
(Antique Bronze)

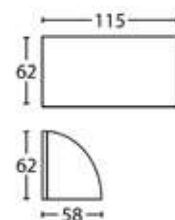
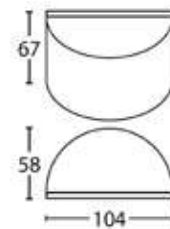

- Exterior surface mounted curved step lights
- Input voltage range: 12-14V DC
- External 12V DC Constant Voltage Control Gear required
- CLA recommended drivers: OTTER and CLA11 series
- Material: solid bronze
- Lamp holder: G4 (Max.20W)
- Globe not included
- Recommended CLA LED globes: G401, CLAL1.58 Series, CLAG4L3CW/WW & CLAG4L15CW



Part No.	Description	Lamp Holder	Max. Wattage	Dimensions	Carton QTY
STE23	WALL 12V S/M Antique Bronze Curved G4 Bi-Pin	G4	20W	58x104x67mm	1/10
STE12	WALL 12V S/M Bronze Lge Curved G4 Bi-Pin	G4	20W	115x62x58mm	1/10

**Unless protected, not recommended for environments with harsh weather conditions or heavy rainfall. IP65 fittings recommended for such environments.*

**To avoid disappointment and warranty problems, please ensure the IP Rating of the chosen product is relevant for the intended use.*

STE13-18 Exterior Lighting

- Exterior LED surface mounted eyelid step lights
- Input voltage range: 12-14V DC
- External 12V DC Constant Voltage control gear required
- Material: Anodized 316 stainless steel or polished solid copper
- LED chips: 3pcs XB-D
- Power factor: 0.95
- Ambient temperature: -40 to 85°C



Tested & Recommended Drivers:

CLADR12W / DRIV1 / OTTER1 / CLA111011 /
 CLA113011 / CLA115011 / CLA1110011 /
 CLA1115011 / CLA1120011

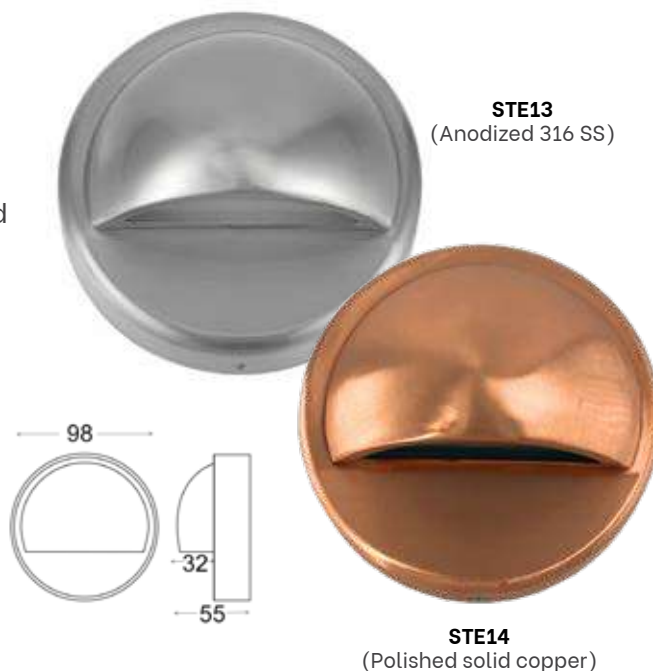

Part No.	Description	Kelvin	Lumens	Watt	CRI	Power Factor	Dimensions	Carton QTY
STE13	WALL 12V Built in LED S/M SS316 Lge Curved	3000K	240LM	3W	80	0.95	Ø98x55mm	1/25
STE14	WALL 12V Built in LED S/M Solid Copper Lge Curved	3000K	240LM	3W	80	0.95	Ø98x55mm	1/25

**Unless protected, not recommended for environments with harsh weather conditions or heavy rainfall. IP65 fittings recommended for such environments. To avoid disappointment and warranty problems, please ensure the IP Rating of the chosen product is relevant for the intended use.*

- Exterior LED surface mounted eyelid step lights
- Input voltage range: 12-14V DC or 220-240V AC
- For 12-14V models: External 12V DC Constant Voltage control gear required
- Material: matt black or titanium aluminium
- Diffuser: PC
- LED chips: 12pcs 2835 LED
- Power factor: 0.98
- Ambient temperature: -40 to 85°C

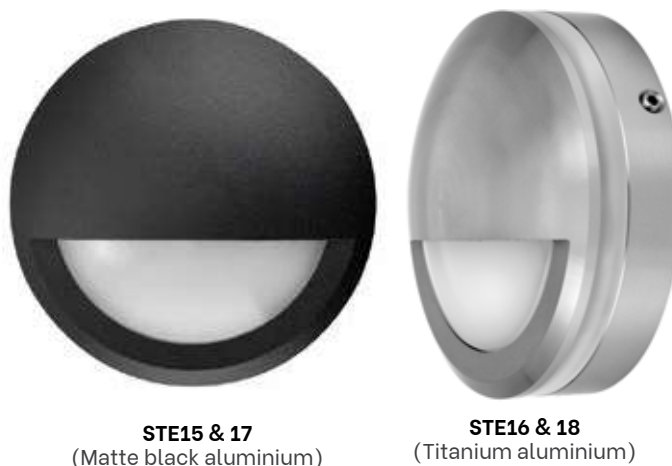

Tested & Recommended Drivers (for STE17&18):

DRIV1 / OTTER1 / CLA111011 / CLA113011 / CLA115011 /
 CLA1110011 / CLA1115011

Part No.	Description	Kelvin	Lumens	Watt	CRI	Power Factor	Dimensions	Carton QTY
STE15	STEP EYELID LED 240V S/M BLK RND	3000K	480LM	6W	75	0.98	Ø98x43mm	1/50
STE16	STEP EYELID LED 240V S/M Titanium RND	3000K	480LM	6W	75	0.98	Ø98x43mm	1/50
STE17	STEP EYELID LED 12V DC S/M BLK RND	3000K	480LM	6W	75	0.98	Ø98x43mm	1/50
STE18	STEP EYELID LED 12V DC S/M Titanium RND	3000K	480LM	6W	75	0.98	Ø98x43mm	1/50

**To avoid disappointment and warranty problems, please ensure the IP Rating of the chosen product is relevant for the intended use.*

STE19-22 Exterior Lighting



STE19-20
(Antique Brass)



STE21-22
(Antique Brass)

- Exterior LED surface mounted step lights
- Input voltage range: 12-14V DC / 220-240V AC
- External 12V DC Constant Voltage control gear required
- Material: solid brass
- Diffuser: PC
- LED chips: 12pcs 2835 LED
- Power factor: 0.98
- Ambient temperature: -40 to 85°C

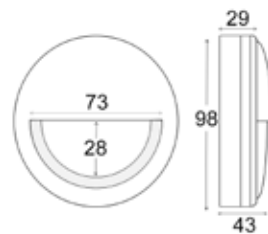

STE19-20 line drawing

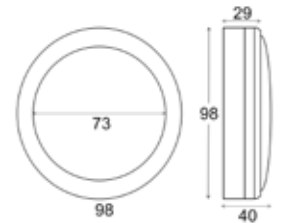

STE21-22 line drawing



Tested & Recommended Drivers (for STE20 & 22):

DRIV1 / OTTER1 / CLA111011 / CLA113011 / CLA115011 / CLA1110011 / CLA1115011

Part No.	Description	Kelvin	Lumens	Watt	CRI	Power Factor	Dimensions	Carton QTY
STE19	STEP EYELID LED 240V S/M Antique Brass	3000K	480LM	6W	75	0.98	Ø98x43mm	1/20
STE20	STEP EYELID LED 12V DC S/M Antique Brass	3000K	480LM	6W	75	0.98	Ø98x43mm	1/20
STE21	STEP LED 240V S/M Antique Brass	3000K	600LM	6W	75	0.98	Ø98x43mm	1/20
STE22	STEP LED 12V DC S/M Antique Brass	3000K	600LM	6W	75	0.98	Ø98x43mm	1/20

*To avoid disappointment and warranty problems, please ensure the IP Rating of the chosen product is relevant for the intended use.



- Exterior LED pillar wall lights
- Input voltage: 12V DC
- External 12V DC Constant Voltage control gear required
- Housing: bronze/ aluminium/ Marine Grade 316 SS
- LED chips: 2835
- CRI: 75
- Ambient temperature: -40 to 85°C
- Not suitable for dimming



Part No.	PDL1SQBL, PDL1QBRZ, PDL1SQSS
Description	WALL/ PILLAR LED S/M SQ 1 WAY
Material	PDL1SQBL: aluminium PDL1QBRZ: bronze PDL1SQSS: 316 SS
Kelvin	3000K
Lumens	300LM
Wattage	3W
LED Chips	6pcs 2835
Power factor	0.98
CRI	75
Dimensions	L 80 x W 80 x D 13mm
Carton QTY	1/20

Part No.	PDLUDRECTBLK, PDLUDRECTBRZ, PDLUDRECTSS
Description	WALL/ PILLAR LED S/M RECT Up/ Down
Material	PDLUDRECTBLK: aluminium PDLUDRECTBRZ: bronze PDLUDRECTSS: 316 SS
Kelvin	3000K
Lumens	2x300LM
Wattage	2x3W
LED Chips	2x6pcs 2835
Power factor	0.98
CRI	75
Dimensions	L 180 x W 80 x D 13mm
Carton QTY	1/20

Tested & Recommended Drivers:
All CLA 12V DC Constant Voltage drivers

Part No.	Min.Load	Max.Load
DRIV1	1.2W	9.6W
OTTER1	1.2W	9.6W
CLA111011	1W	8W
CLA113011	3W	24W



PDL1SQBL
(Black aluminium)



PDL1QBRZ
(Bronze)



PDL1SQSS
(316 Satinless steel)

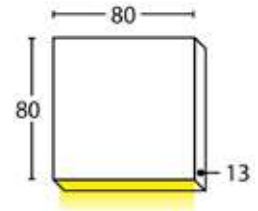

PDLUDRECTBLK
(Black aluminium)



PDLUDRECTBRZ
(Bronze)



PDLUDRECTSS
(316 Stainless steel)

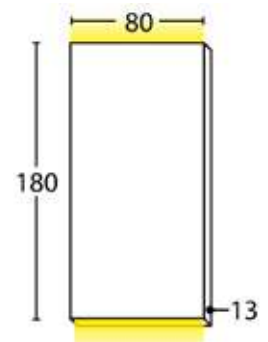

*To avoid disappointment and warranty problems, please ensure the IP Rating of the chosen product is relevant for the intended use.

Adjustable Pillar Spot Lights Exterior Lighting



SM1ACEC & SG1ACEC



SM1ACECA & SG1ACECA

- Exterior single adjustable wall pillar/ spot lights
- Input voltage: 12V or 240V
- Material: solid copper (light weight)
- Anti-glare honey comb louver
- Lamp holder: GU10 or MR16
- Max 35W globe for GU10 models
- Max 20W globe for MR16 models
- Globes not included

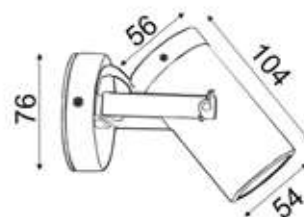

 GU10	 MR16	IP54 Rated	2YEAR Replacement Warranty
--	--	----------------------	---

Part No.	Description	Lamp Holder	Max. Watt	Back Plate	Carton QTY
SG1ACEC	WALL GU10 PILLAR SPOT S/ADJ (Brass Bracket) COP	GU10	35W	Ø76mm	1/20
SG1ACECA	WALL GU10 PILLAR SPOT S/ADJ (Brass Bracket) AGED COP	GU10	35W	Ø76mm	1/20
SM1ACEC	WALL MR16 12V SPOT S/ADJ (Brass Bracket) COP	MR16	20W	Ø76mm	1/20
SM1ACECA	WALL MR16 PILLAR SPOT S/ADJ (Brass Bracket) AGED COP	MR16	20W	Ø76mm	1/20

**Unless protected, not recommended for environments with harsh weather conditions or heavy rainfall. IP65 fittings recommended for such environments.*

**To avoid disappointment and warranty problems, please ensure the IP Rating of the chosen product is relevant for the intended use.*

GU10 Pillar Lights (Copper) Exterior Lighting



PGUDC

PG1FC



PG1AC



PG2AC

- Exterior surface mounted pillar lights
- Input voltage range: 110-265V AC 50/60Hz
- Material: copper
- Colour: copper
- Lamp holder: GU10 (Max.35W)
- Globes not included

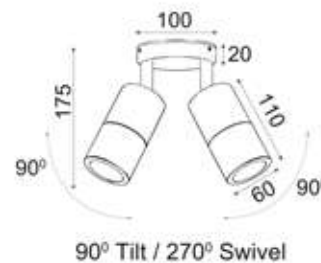
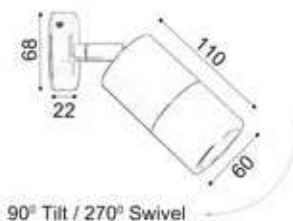
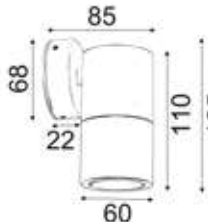
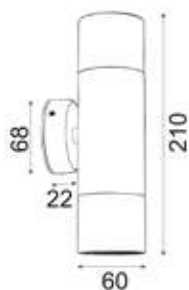

Part No.	Description	Lamp Holder	Max. Watt	Back Plate	Carton QTY
PGUDC	WALL GU10 X 2 (Max 35W) PILLAR UP/DN COPPER	2xGU10	2x35W	Ø68x22mm	1/10
PG1FC	WALL GU10 (Max 35W) PILLAR FIXED COPPER	1xGU10	35W	Ø68x22mm	1/10
PG1AC	WALL GU10 (Max 35W) PILLAR S/ADJ COPPER	1xGU10	35W	Ø68x22mm	1/10
PG2AC	WALL GU10 X 2 (Max 35W) PILLAR D/ADJ RND BASE COPPER	2xGU10	2x35W	Ø100x20mm	1/10

*To avoid disappointment and warranty problems, please ensure the IP Rating of the chosen product is relevant for the intended use.

GU10 Pillar Lights (Light Weight Copper) Exterior Lighting



PGUDCEC

PG1FCEC



PG1ACEC



PG2ACEC

- Exterior surface mounted pillar lights
- Input voltage range: 110-265V AC 50/60Hz
- Material: copper (light weight)
- Colour: copper
- Anti-glare honey comb louver
- Lamp holder: GU10 (Max.35W)
- Globes not included

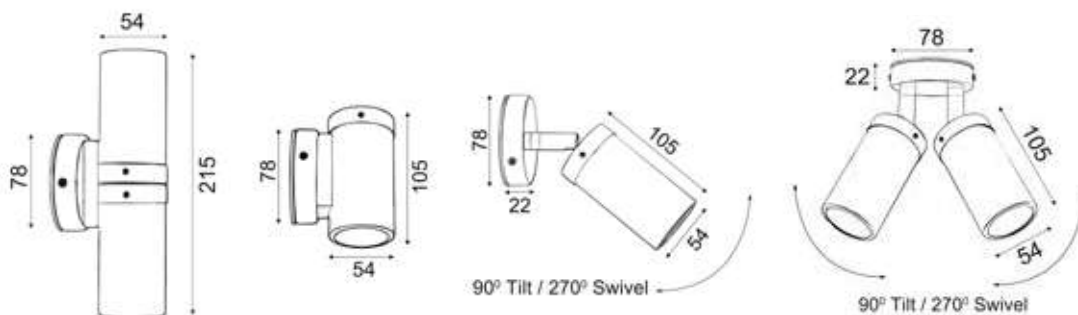

Part No.	Description	Lamp Holder	Max. Watt	Back Plate	Carton QTY
PGUDCEC	WALL GU10 X 2 (Max 35W) PILLAR UP/DN COPPER	2xGU10	2x35W	Ø78x22mm	1/20
PG1FCEC	WALL GU10 (Max 35W) PILLAR FIXED COPPER	1xGU10	35W	Ø78x22mm	1/20
PG1ACEC	WALL GU10 (Max 35W) PILLAR S/ADJ COPPER	1xGU10	35W	Ø78x22mm	1/20
PG2ACEC	WALL GU10 X 2 (Max 35W) PILLAR D/ADJ RND BASE COPPER	2xGU10	2x35W	Ø78x22mm	1/20

*Unless protected, not recommended for environments with harsh weather conditions or heavy rainfall. IP65 fittings recommended for such environments.

*To avoid disappointment and warranty problems, please ensure the IP Rating of the chosen product is relevant for the intended use.

GU10 Pillar Lights (Aged Copper) Exterior Lighting



PGUDCECA

PG1FCECA



PG1ACECA



PG2ACECA

- Exterior surface mounted pillar lights
- Input voltage range: 110–265V AC 50/60Hz
- Material: copper (light weight)
- Colour: aged copper
- Anti-glare honey comb louver
- Lamp holder: GU10 (Max.35W)
- Globes not included

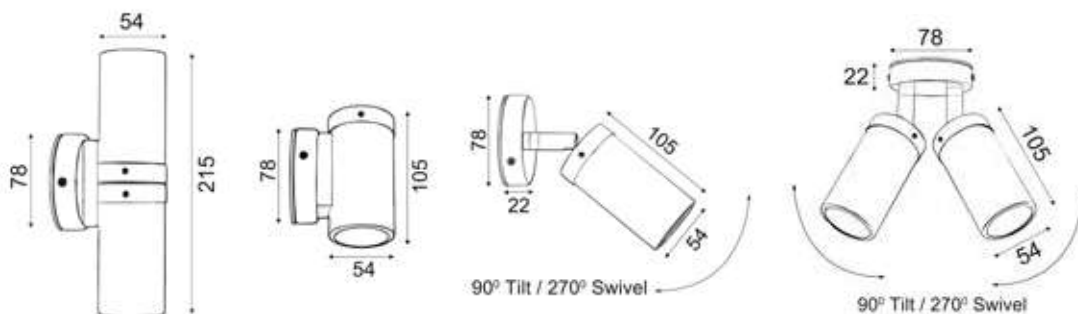

Part No.	Description	Lamp Holder	Max. Watt	Back Plate	Carton QTY
PGUDCECA	WALL GU10 X 2 (Max 35W) PILLAR UP/DN AGED COP	2xGU10	2x35W	Ø78x22mm	1/20
PG1FCECA	WALL GU10 (Max 35W) PILLAR FIXED AGED COP	1xGU10	35W	Ø78x22mm	1/20
PG1ACECA	WALL GU10 (Max 35W) PILLAR S/ADJ AGED COPP	1xGU10	35W	Ø78x22mm	1/20
PG2ACECA	WALL GU10 X 2 (Max 35W) PILLAR D/ADJ RND BASE AGED COP	2xGU10	2x35W	Ø78x22mm	1/20

*Unless protected, not recommended for environments with harsh weather conditions or heavy rainfall. IP65 fittings recommended for such environments.

*To avoid disappointment and warranty problems, please ensure the IP Rating of the chosen product is relevant for the intended use.

GU10 Pillar Lights (Antique Brass) Exterior Lighting



PGUDBR

PG1FBR



PG1ABR



PG2ABR

- Exterior surface mounted pillar lights
- Input voltage range: 110-265V AC 50/60Hz
- Material: solid brass
- Colour: antique brass
- Lamp holder: GU10 (Max.35W)
- Globes not included

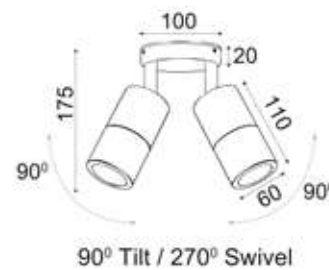
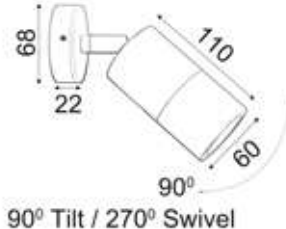
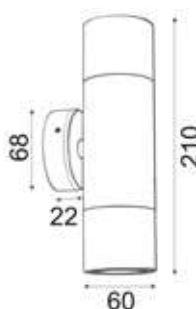

Part No.	Description	Lamp Holder	Max. Watt	Back Plate	Carton QTY
PGUDBR	WALL GU10 X 2 (Max 35W) PILLAR UP/DN Antique Brass	2xGU10	2x35W	Ø68x22mm	1/10
PG1FBR	WALL GU10 (Max 35W) PILLAR FIXED Antique Brass	1xGU10	35W	Ø68x22mm	1/10
PG1ABR	WALL GU10 (Max 35W) PILLAR S/ADJ Antique Brass	1xGU10	35W	Ø68x22mm	1/10
PG2ABR	WALL GU10 X 2 (Max 35W) PILLAR D/ADJ RND BASE Antique Brass	2xGU10	2x35W	Ø100x20mm	1/10

*To avoid disappointment and warranty problems, please ensure the IP Rating of the chosen product is relevant for the intended use.

GU10 Pillar Lights (Black Aluminium) Exterior Lighting



PGUDBL

PG1FBL



PG1ABL



PG2ABL

- Exterior surface mounted pillar lights
- Input voltage range: 110-265V AC 50/60Hz
- Material: aluminium
- Colour: powder coated black
- Lamp holder: GU10 (Max.35W)
- Globes not included

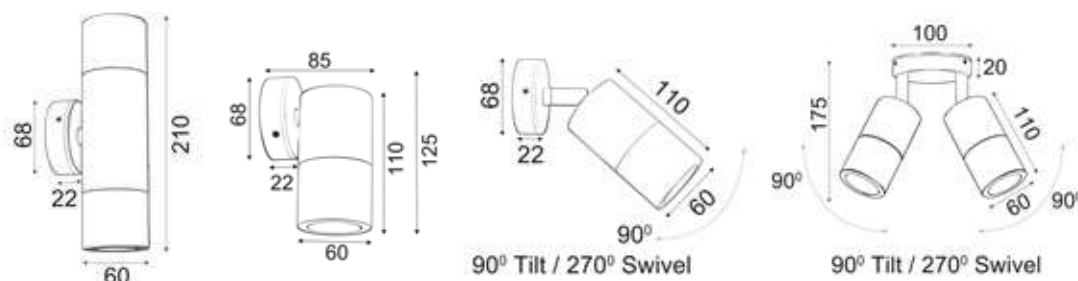

Part No.	Description	Lamp Holder	Max. Watt	Back Plate	Carton QTY
PGUDBL	WALL GU10 X 2 (Max 35W) PILLAR UP/DN BLK	2xGU10	2x35W	Ø68x22mm	1/20
PG1FBL	WALL GU10 (Max 35W) PILLAR FIXED BLK	1xGU10	35W	Ø68x22mm	1/20
PG1ABL	WALL GU10 (Max 35W) PILLAR S/ADJ BLK	1xGU10	35W	Ø68x22mm	1/25
PG2ABL	WALL GU10 X 2 (Max 35W) PILLAR D/ADJ RND BASE BLK	2xGU10	2x35W	Ø100x20mm	1/10

*To avoid disappointment and warranty problems, please ensure the IP Rating of the chosen product is relevant for the intended use.

- Exterior surface mounted pillar bar lights
- Input voltage range: 110–265V AC 50/60Hz
- Material: aluminium
- Colour: powder coated black
- Lamp holder: GU10 (Max.35W)
- Globes not included



PG2BARBL

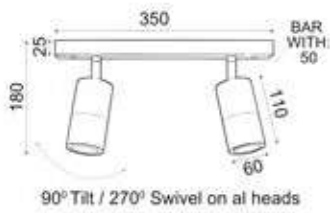

PG3BARBL

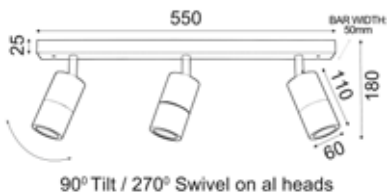

PG4BARBL

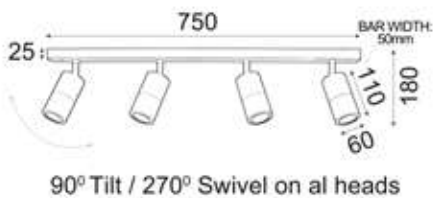

PG4SQBL

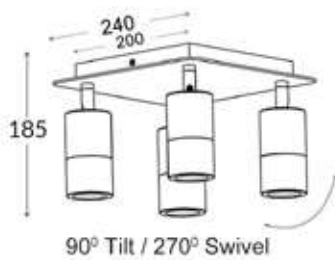

Part No.	Description	Lamp Holder	Max. Watt	Back Plate	Carton QTY
PG2BARBL	WALL GU10 X 2 (Max 35W) PILLAR D/ADJ BAR BLK	2xGU10	2x35W	350x50x25mm	1/10
PG3BARBL	WALL GU10 X 3 (Max 35W) PILLAR 3 Light BAR BLK	3xGU10	3x35W	550x50x25mm	1/10
PG4BARBL	WALL GU10 X 4 (Max 35W) PILLAR 4 Light BAR BLK	4xGU10	4x35W	750x50x25mm	1/10
PG4SQBL	WALL GU10 X 4 (Max 35W) PILLAR 4 Light BAR SQ BLK	4xGU10	4x35W	240x240mm	1/4

*Unless protected, not recommended for environments with harsh weather conditions or heavy rainfall. IP65 fittings recommended for such environments.

*To avoid disappointment and warranty problems, please ensure the IP Rating of the chosen product is relevant for the intended use.

GU10 Pillar Lights (White Aluminium) Exterior Lighting



PGUDWH



PG1FWH



PG1AWH



PG2AWH

- Exterior surface mounted pillar lights
- Input voltage range: 110-265V AC 50/60Hz
- Material: aluminium
- Colour: powder coated white
- Lamp holder: GU10 (Max.35W)
- Globes not included

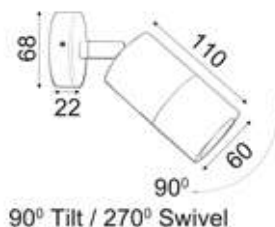
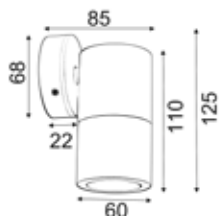

90° Tilt / 270° Swivel

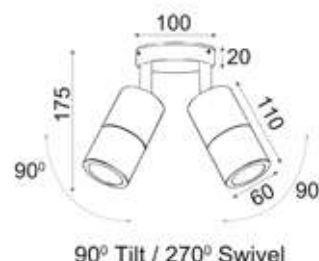

90° Tilt / 270° Swivel

Part No.	Description	Lamp Holder	Max. Watt	Back Plate	Carton QTY
PGUDWH	WALL GU10 X 2 (Max 35W) PILLAR UP/DN WHITE	2xGU10	2x35W	Ø68x22mm	1/20
PG1FWH	WALL GU10 (Max 35W) PILLAR FIXED WHITE	1xGU10	35W	Ø68x22mm	1/20
PG1AWH	WALL GU10 (Max 35W) PILLAR S/ADJ WHITE	1xGU10	35W	Ø68x22mm	1/25
PG2AWH	WALL GU10 X 2 (Max 35W) PILLAR D/ADJ RND BASE WHITE	2xGU10	2x35W	Ø100x20mm	1/10

*To avoid disappointment and warranty problems, please ensure the IP Rating of the chosen product is relevant for the intended use.

- Exterior surface mounted pillar bar lights
- Input voltage range: 110-265V AC 50/60Hz
- Material: aluminium
- Colour: powder coated white
- Lamp holder: GU10 (Max.35W)
- Globes not included

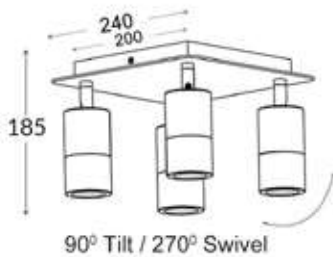
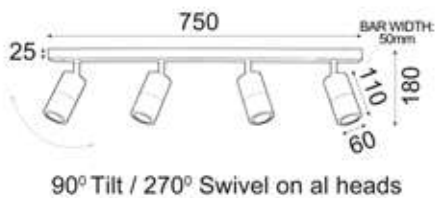
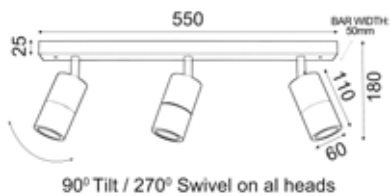
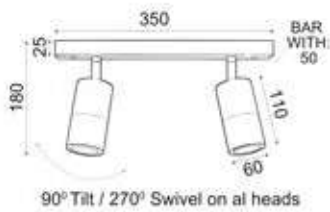

PG2BARWH



PG3BARWH



PG4BARWH



PG4SQWH

Part No.	Description	Lamp Holder	Max. Watt	Back Plate	Carton QTY
PG2BARWH	WALL GU10 X 2 (Max 35W) PILLAR D/ADJ BAR WH	2xGU10	2x35W	350x50x25mm	1/10
PG3BARWH	WALL GU10 X 3 (Max 35W) PILLAR 3 Light BAR WH	3xGU10	3x35W	550x50x25mm	1/10
PG4BARWH	WALL GU10 X 4 (Max 35W) PILLAR 4 Light BAR WH	4xGU10	4x35W	750x50x25mm	1/10
PG4SQWH	WALL GU10 X 4 (Max 35W) PILLAR 4 Light BAR SQ WH	4xGU10	4x35W	240x240mm	1/4

*Unless protected, not recommended for environments with harsh weather conditions or heavy rainfall. IP65 fittings recommended for such environments.

*To avoid disappointment and warranty problems, please ensure the IP Rating of the chosen product is relevant for the intended use.

GU10 Pillar Lights (Titanium Aluminium) Exterior Lighting



PGUDT

PG1FT



PG1AT



PG2AT

- Exterior surface mounted pillar lights
- Input voltage range: 110-265V AC 50/60Hz
- Material: anodized aluminium
- Colour: titanium
- Lamp holder: GU10 (Max.35W)
- Globes not included

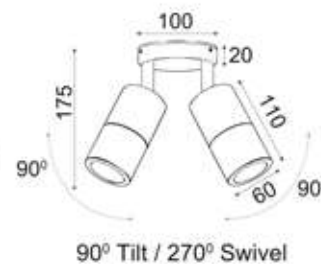
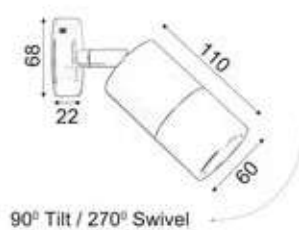
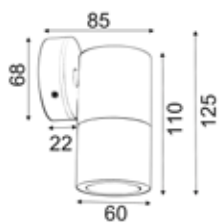
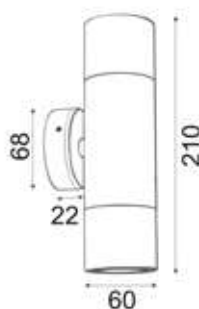

Part No.	Description	Lamp Holder	Max. Watt	Back Plate	Carton QTY
PGUDT	WALL GU10 X 2 (Max 35W) PILLAR UP/DN TITANIUM	2xGU10	2x35W	Ø68x22mm	1/20
PG1FT	WALL GU10 (Max 35W) PILLAR FIXED TITANIUM	1xGU10	35W	Ø68x22mm	1/20
PG1AT	WALL GU10 (Max 35W) PILLAR S/ADJ TITANIUM	1xGU10	35W	Ø68x22mm	1/20
PG2AT	WALL GU10 X 2 (Max 35W) PILLAR D/ADJ RND BASE TITANIUM	2xGU10	2x35W	Ø100x20mm	1/10

*To avoid disappointment and warranty problems, please ensure the IP Rating of the chosen product is relevant for the intended use.

- Exterior surface mounted pillar bar lights
- Input voltage range: 110-265V AC 50/60Hz
- Material: Anodized aluminium
- Colour: titanium
- Lamp holder: GU10 (Max.35W)
- Globes not included



PG2BART

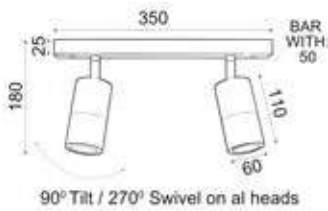

PG3BART

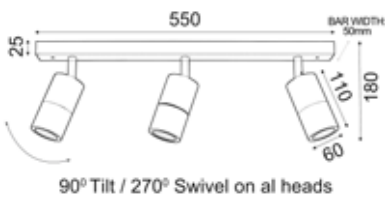

PG4BART

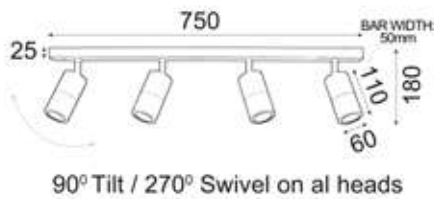

PG4SQT

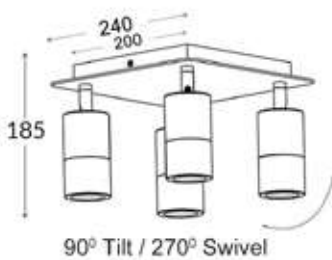

Part No.	Description	Lamp Holder	Max. Watt	Back Plate	Carton QTY
PG2BART	WALL GU10 X 2 (Max 35W) PILLAR D/ADJ BAR TITANIUM	2xGU10	2x35W	350x50x25mm	1/10
PG3BART	WALL GU10 X 3 (Max 35W) PILLAR 3 Light BAR TITANIUM	3xGU10	3x35W	550x50x25mm	1/10
PG4BART	WALL GU10 X 4 (Max 35W) PILLAR 4 Light BAR TITANIUM	4xGU10	4x35W	750x50x25mm	1/10
PG4SQT	WALL GU10 X 4 (Max 35W) PILLAR 4 Light BAR SQ TITANIUM	4XGU10	4x35W	240x240mm	1/4

*Unless protected, not recommended for environments with harsh weather conditions or heavy rainfall. IP65 fittings recommended for such environments.

*To avoid disappointment and warranty problems, please ensure the IP Rating of the chosen product is relevant for the intended use.

GU10 Pillar Lights (316 Stainless Steel) Exterior Lighting



PGUDSS

PG1FSS



PG1ASS



PG2ASS

- Exterior surface mounted pillar lights
- Input voltage range: 110–265V AC 50/60Hz
- Material: 316 stainless steel
- Colour: stainless steel
- Lamp holder: GU10 (Max.35W)
- Globes not included

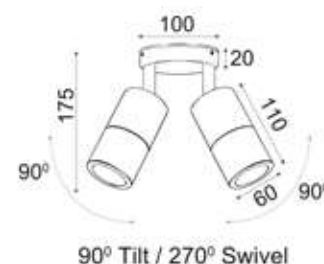
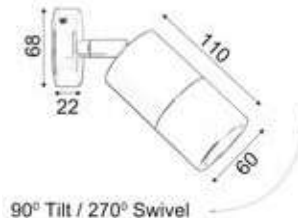
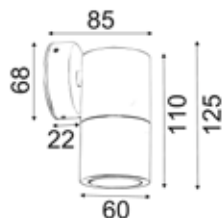
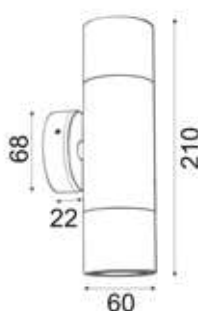

Part No.	Description	Lamp Holder	Max. Watt	Back Plate	Carton QTY
PGUDSS	WALL GU10 X 2 (Max 35W) PILLAR UP/DN 316 SS	2xGU10	2x35W	Ø68x22mm	1/10
PG1FSS	WALL GU10 (Max 35W) PILLAR FIXED 316 SS	1xGU10	35W	Ø68x22mm	1/10
PG1ASS	WALL GU10 (Max 35W) PILLAR S/ADJ 316 SS	1xGU10	35W	Ø68x22mm	1/20
PG2ASS	WALL GU10 X 2 (Max 35W) PILLAR D/ADJ RND BASE 316 SS	2xGU10	2x35W	Ø100x20mm	1/10

*To avoid disappointment and warranty problems, please ensure the IP Rating of the chosen product is relevant for the intended use.

GU10 Pillar Lights (Matte Grey Aluminium) Exterior Lighting



PGUDSIL

PG1FSIL



PG1ASIL



PG2ASIL

- Exterior surface mounted pillar lights
- Input voltage range: 110-265V AC 50/60Hz
- Material: aluminium
- Colour: powder coated matte grey
- Lamp holder: GU10 (Max.35W)
- Globes not included

 GU10	IP65 Rated	2YEAR Replacement Warranty
---	----------------------	---

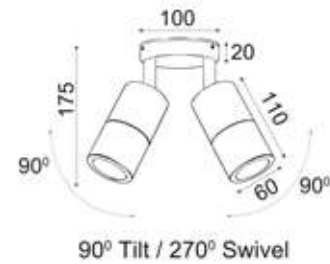
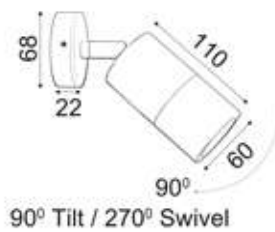
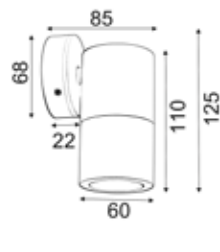
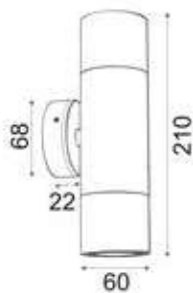

Part No.	Description	Lamp Holder	Max. Watt	Back Plate	Carton QTY
PGUDSIL	WALL GU10 X 2 (Max 35W) PILLAR UP/DN MATTE GREY	2xGU10	2x35W	Ø68x22mm	1/20
PG1FSIL	WALL GU10 (Max 35W) PILLAR FIXED MATTE GREY	1xGU10	35W	Ø68x22mm	1/20
PG1ASIL	WALL GU10 (Max 35W) PILLAR S/ADJ MATTE GREY	1xGU10	35W	Ø68x22mm	1/25
PG2ASIL	WALL GU10 X 2 (Max 35W) PILLAR D/ADJ RND BASE MATTE GREY	2xGU10	2x35W	Ø100x20mm	1/10

**To avoid disappointment and warranty problems, please ensure the IP Rating of the chosen product is relevant for the intended use.*

GU10 Pillar Lights (Anodized Aluminium) Exterior Lighting



PGUDSHSIL

PG1FSHSIL



PG1ASHSIL



PG2ASHSIL

- Exterior surface mounted pillar lights
- Input voltage range: 110-265V AC 50/60Hz
- Material: aluminium
- Colour: anodized aluminium
- Lamp holder: GU10 (Max.35W)
- Globes not included

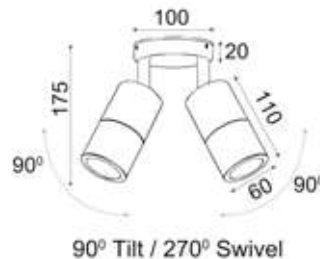
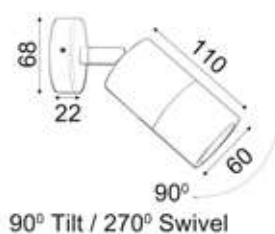
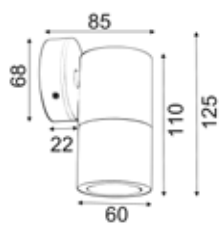
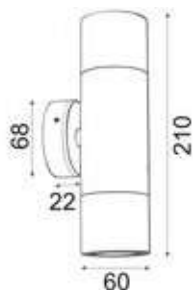

Part No.	Description	Lamp Holder	Max. Watt	Back Plate	Carton QTY
PGUDSHSIL	WALL GU10X2 (Max 35W) PILLAR UP/DN ANODIZED AL	2xGU10	2x35W	Ø68x22mm	1/20
PG1FSHSIL	WALL GU10 (Max 35W) PILLAR FIXED ANODIZED AL	1xGU10	35W	Ø68x22mm	1/20
PG1ASHSIL	WALL GU10 (Max 35W) PILLAR S/ADJ ANODIZED AL	1xGU10	35W	Ø68x22mm	1/20
PG2ASHSIL	WALL GU10X2 (Max 35W) PILLAR D/ADJ RND BASE ANODIZED AL	2xGU10	2x35W	Ø100x20mm	1/10

*To avoid disappointment and warranty problems, please ensure the IP Rating of the chosen product is relevant for the intended use.

MR16 Pillar Lights (Copper) Exterior Lighting



PMUDC

PM1FC



PM1AC



PM2AC

- Exterior surface mounted pillar lights
- Input voltage range: 12-24V AC/DC
- Material: copper
- Colour: copper
- Lamp holder: MR16 (Max.20W)
- Globes not included
- Remote control gear required

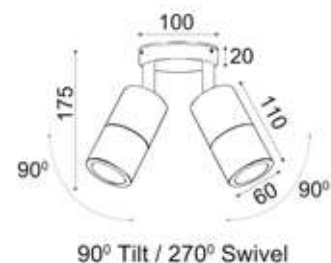
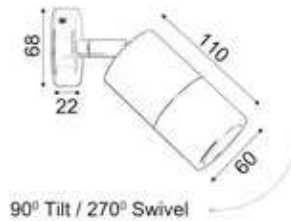
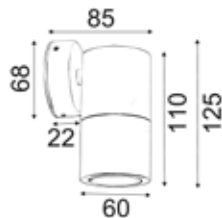
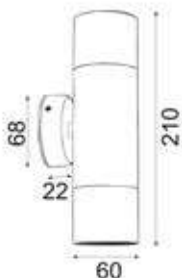

Part No.	Description	Lamp Holder	Max. Watt	Back Plate	Carton QTY
PMUDC	WALL MR16 X 2 (Max 20W) PILLAR UP/DN COP	2xMR16	2x20W	Ø68x22mm	1/10
PM1FC	WALL MR16 (Max 20W) PILLAR FIXED COP	1xMR16	20W	Ø68x22mm	1/25
PM1AC	WALL MR16 (Max 20W) PILLAR S/ADJ COP	1xMR16	20W	Ø68x22mm	1/25
PM2AC	WALL MR16 X 2 (Max 20W) PILLAR D/ADJ RND BASE COP	2xMR16	2x20W	Ø100x20mm	1/10

*To avoid disappointment and warranty problems, please ensure the IP Rating of the chosen product is relevant for the intended use.

MR16 Pillar Lights (Light Weight Copper) Exterior Lighting



PMUDCEC

PM1FCEC



PM1ACEC



PM2ACEC

- Exterior surface mounted pillar lights
- Input voltage range: 12-24V AC/DC
- Material: copper (light weight)
- Colour: copper
- Anti-glare honey comb louver
- Lamp holder: MR16 (Max.20W)
- Globes not included
- Remote control gear required

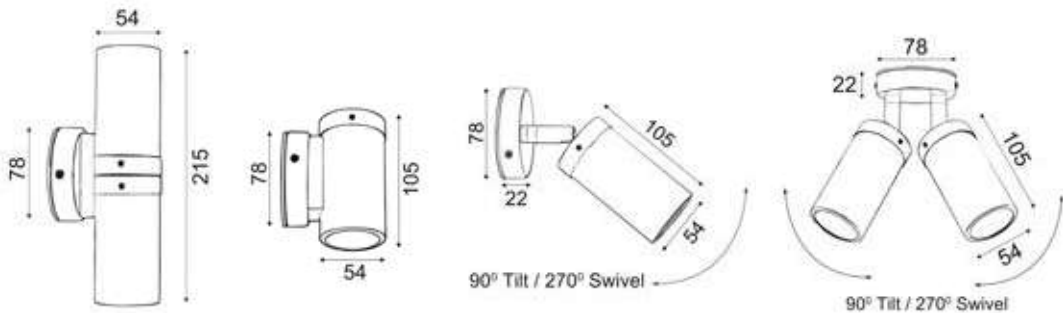

Part No.	Description	Lamp Holder	Max. Watt	Back Plate	Carton QTY
PMUDCEC	WALL MR16 12V PILLAR UP/DN COP	2xMR16	2x20W	Ø78x22mm	1/20
PM1FCEC	WALL MR16 (Max 20W) 12V PILLAR FIXED COP	1xMR16	20W	Ø78x22mm	1/20
PM1ACEC	WALL MR16 12V PILLAR S/ADJ COP (Brass knuckle)	1xMR16	20W	Ø78x22mm	1/20
PM2ACEC	WALL MR16 12V PILLAR D/ADJ RND BASE COP	2xMR16	2x20W	Ø78x22mm	1/20

*Unless protected, not recommended for environments with harsh weather conditions or heavy rainfall. IP65 fittings recommended for such environments.

*To avoid disappointment and warranty problems, please ensure the IP Rating of the chosen product is relevant for the intended use.

MR16 Pillar Lights (Aged Copper) Exterior Lighting



PMUDCECA

PM1FCECA



PM1ACECA



PM2ACECA

- Exterior surface mounted pillar lights
- Input voltage range: 12-24V AC/DC
- Material: copper (light weight)
- Colour: aged copper
- Anti-glare honey comb louver
- Lamp holder: MR16 (Max.20W)
- Globes not included
- Remote control gear required

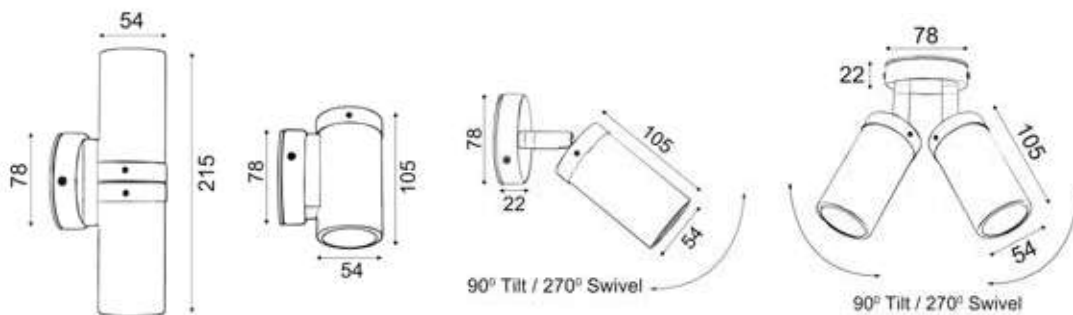

Part No.	Description	Lamp Holder	Max. Watt	Back Plate	Carton QTY
PMUDCECA	WALL MR16 12V PILLAR UP/DN AGED COP	2xMR16	2x20W	Ø78x22mm	1/20
PM1FCECA	WALL MR16 (Max 20W) 12V PILLAR FIXED AGED COP	1xMR16	20W	Ø78x22mm	1/20
PM1ACECA	WALL MR16 12V PILLAR S/ADJ AGED COP (Brass knuckle)	1xMR16	20W	Ø78x22mm	1/20
PM2ACECA	WALL MR16 12V PILLAR D/ADJ RND BASE AGED COP	2xMR16	2x20W	Ø78x22mm	1/20

*Unless protected, not recommended for environments with harsh weather conditions or heavy rainfall. IP65 fittings recommended for such environments.

*To avoid disappointment and warranty problems, please ensure the IP Rating of the chosen product is relevant for the intended use.

MR16 Pillar Lights (Antique Brass) Exterior Lighting



PMUDBR

PM1FBR



PM1ABR



PM2ABR

- Exterior surface mounted pillar lights
- Input voltage range: 12-24V AC/DC
- Material: solid brass
- Colour: antique brass
- Lamp holder: MR16 (Max.20W)
- Globes not included
- Remote control gear required

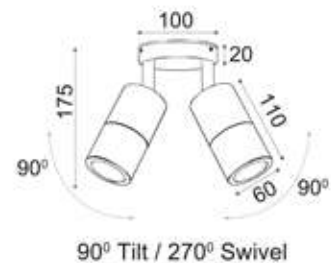
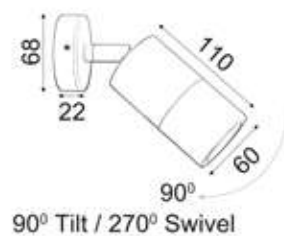
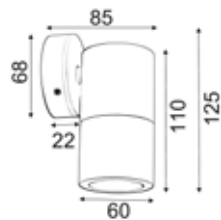
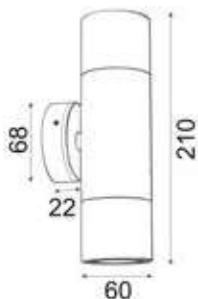

Part No.	Description	Lamp Holder	Max. Watt	Back Plate	Carton QTY
PMUDBR	WALL MR16X2 (Max 20W) PILLAR UP/DN ANTIQUE BRASS	2xMR16	2x20W	Ø68x22mm	1/10
PM1FBR	WALL MR16 (Max 20W) PILLAR FIXED ANTIQUE BRASS	1xMR16	20W	Ø68x22mm	1/10
PM1ABR	WALL MR16 (Max 20W) PILLAR S/ADJ ANTIQUE BRASS	1xMR16	20W	Ø68x22mm	1/10
PM2ABR	WALL MR16X2 (Max 20W) PILLAR D/ADJ RND BASE ANTIQUE BRASS	2xMR16	2x20W	Ø100x20mm	1/10

*To avoid disappointment and warranty problems, please ensure the IP Rating of the chosen product is relevant for the intended use.

MR16 Pillar Lights (316 Stainless Steel) Exterior Lighting



PMUDSS

PM1FSS



PM1ASS



PM2ASS

- Exterior surface mounted pillar lights
- Input voltage range: 12-24V AC/DC
- Material: 316 stainless steel
- Colour: stainless steel
- Lamp holder: MR16 (Max.20W)
- Globes not included
- Remote control gear required

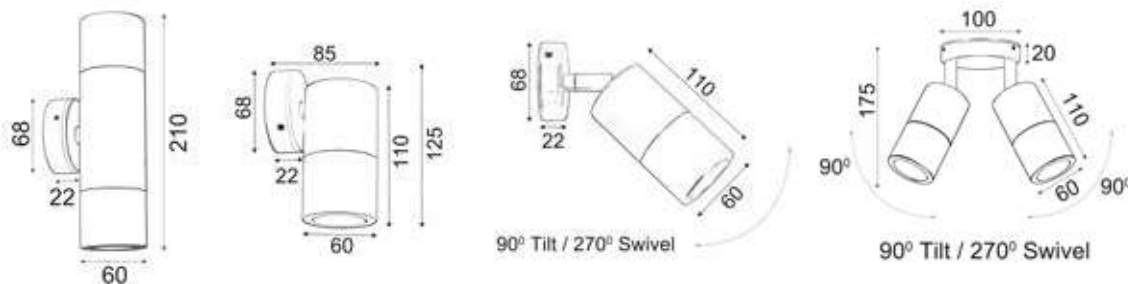

Part No.	Description	Lamp Holder	Max. Watt	Back Plate	Carton QTY
PMUDSS	WALL MR16 X 2 (Max 20W) PILLAR UP/DN 316 SS	2xMR16	2x20W	Ø68x22mm	1/10
PM1FSS	WALL MR16 (Max 20W) PILLAR FIXED 316 SS	1xMR16	20W	Ø68x22mm	1/25
PM1ASS	WALL MR16 (Max 20W) PILLAR S/ADJ 316 SS	1xMR16	20W	Ø68x22mm	1/25
PM2ASS	WALL MR16X2 (Max 20W) PILLAR D/ADJ RND BASE 316 SS	2xMR16	2x20W	Ø100x20mm	1/10

*To avoid disappointment and warranty problems, please ensure the IP Rating of the chosen product is relevant for the intended use.

MR16 Pillar Lights (Black Aluminium) Exterior Lighting



PMUDBL

PM1FBL



PM1ABL



PM2ABL

- Exterior surface mounted pillar lights
- Input voltage range: 12-24V AC/DC
- Material: aluminium
- Colour: powder coated black
- Lamp holder: MR16 (Max.20W)
- Globes not included
- Remote control gear required

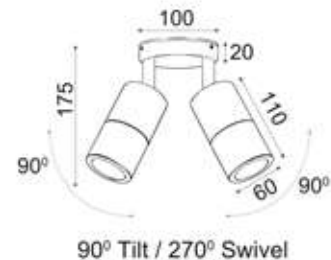
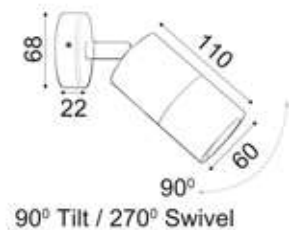
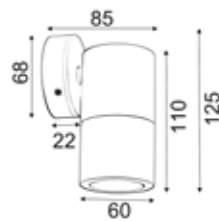
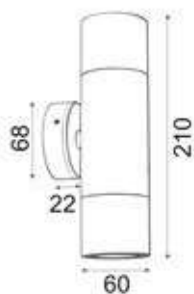

Part No.	Description	Lamp Holder	Max. Watt	Back Plate	Carton QTY
PMUDBL	WALL MR16 X 2 (Max 20W) PILLAR UP/DN BLK	2xMR16	2x20W	Ø68x22mm	1/25
PM1FBL	WALL MR16 (Max 20W) PILLAR FIXED BLK	1xMR16	20W	Ø68x22mm	1/25
PM1ABL	WALL MR16 (Max 20W) PILLAR S/ADJ BLK	1xMR16	20W	Ø68x22mm	1/25
PM2ABL	WALL MR16 X 2 (Max 20W) PILLAR D/ADJ RND BASE BLK	2xMR16	2x20W	Ø100x20mm	1/10

*To avoid disappointment and warranty problems, please ensure the IP Rating of the chosen product is relevant for the intended use.

MR16 Pillar Lights (White Aluminium) Exterior Lighting



PMUDWH

PM1FWH



PM1AWH



PM2AWH

- Exterior surface mounted pillar lights
- Input voltage range: 12-24V AC/DC
- Material: aluminium
- Colour: white
- Lamp holder: MR16 (Max.20W)
- Globes not included
- Remote control gear required

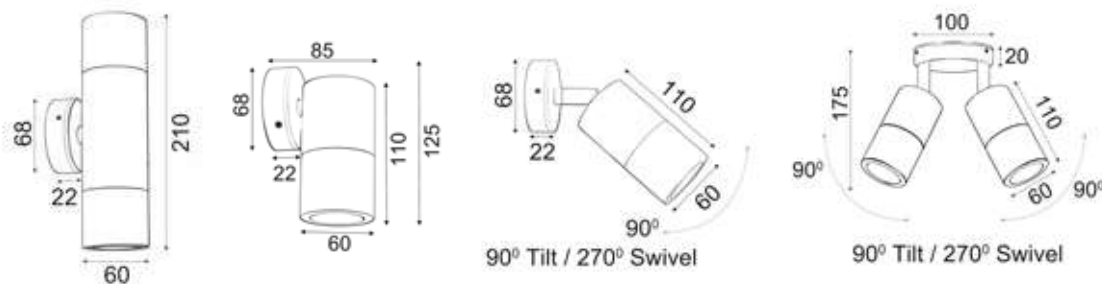

Part No.	Description	Lamp Holder	Max. Watt	Back Plate	Carton QTY
PMUDWH	WALL MR16 X 2 (Max 20W) PILLAR UP/DN WHITE	2xMR16	2x20W	Ø68x22mm	1/25
PM1FWH	WALL MR16 (Max 20W) PILLAR FIXED WHITE	1xMR16	20W	Ø68x22mm	1/25
PM1AWH	WALL MR16 (Max 20W) PILLAR S/ADJ WHITE	1xMR16	20W	Ø68x22mm	1/25
PM2AWH	WALL MR16X2 (Max 20W) PILLAR D/ADJ RND BASE WHITE	2xMR16	2x20W	Ø100x20mm	1/10

*To avoid disappointment and warranty problems, please ensure the IP Rating of the chosen product is relevant for the intended use.

MR16 Pillar Lights (Matte Grey Aluminium) Exterior Lighting



PMUDSIL

PM1FSIL



PM1ASIL



PM2ASIL

- Exterior surface mounted pillar lights
- Input voltage range: 12-24V AC/DC
- Material: aluminium
- Colour: matte grey
- Lamp holder: MR16 (Max.20W)
- Globes not included
- Remote control gear required

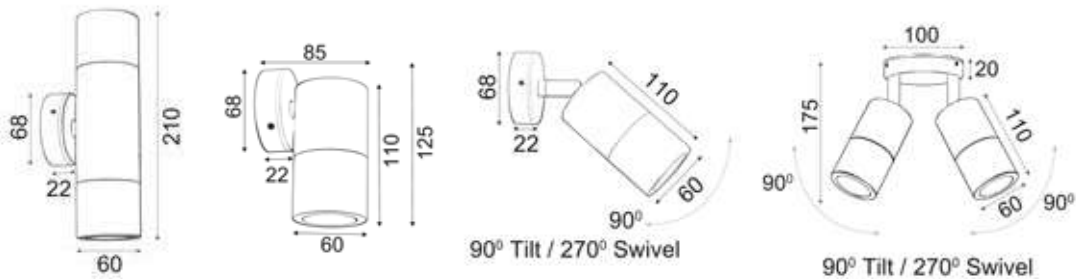

Part No.	Description	Lamp Holder	Max. Watt	Back Plate	Carton QTY
PMUDSIL	WALL MR16 X 2 (Max 20W) PILLAR UP/DN MATTE GREY	2xMR16	2x20W	Ø68x22mm	1/25
PM1FSIL	WALL MR16 (Max 20W) PILLAR FIXED MATTE GREY	1xMR16	20W	Ø68x22mm	1/25
PM1ASIL	WALL MR16 (Max 20W) PILLAR S/ADJ MATTE GREY	1xMR16	20W	Ø68x22mm	1/25
PM2ASIL	WALL MR16 X 2 (Max 20W) PILLAR D/ADJ RND BASE MATTE GREY	2xMR16	2x20W	Ø100x20mm	1/10

*To avoid disappointment and warranty problems, please ensure the IP Rating of the chosen product is relevant for the intended use.

MR16 Pillar Lights (Anodized Aluminium) Exterior Lighting



PMUDSHSIL

PM1FHSIL



PM1ASHSIL



PM2ASHSIL

- Exterior surface mounted pillar lights
- Input voltage range: 12-24V AC/DC
- Material: aluminium
- Colour: anodized aluminium
- Lamp holder: MR16 (Max.20W)
- Globes not included
- Remote control gear required

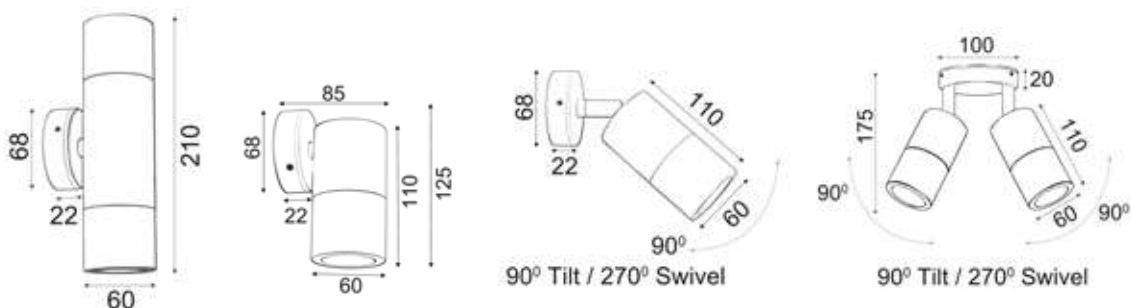

Part No.	Description	Lamp Holder	Max. Watt	Back Plate	Carton QTY
PMUDSHSIL	WALL MR16 X 2 (Max 20W) PILLAR UP/DN ANODIZED AL	2xMR16	2x20W	Ø68x22mm	1/25
PM1FHSIL	WALL MR16 (Max 20W) PILLAR FIXED MATTE ANODIZED AL	1xMR16	20W	Ø68x22mm	1/25
PM1ASHSIL	WALL MR16 (Max 20W) PILLAR S/ADJ MATTE ANODIZED AL	1xMR16	20W	Ø68x22mm	1/25
PM2ASHSIL	WALL MR16X2 (Max 20W) PILLAR D/ADJ RND BASE ANODIZED AL	2xMR16	2x20W	Ø100x20mm	1/10

*To avoid disappointment and warranty problems, please ensure the IP Rating of the chosen product is relevant for the intended use.

MR16 Pillar Lights (Titanium Aluminium) Exterior Lighting



PMUDT

PM1FT



PM1AT



PM2AT

- Exterior surface mounted pillar lights
- Input voltage range: 12-24V AC/DC
- Material: anodized aluminium
- Colour: titanium
- Lamp holder: MR16 (Max.20W)
- Globes not included
- Remote control gear required

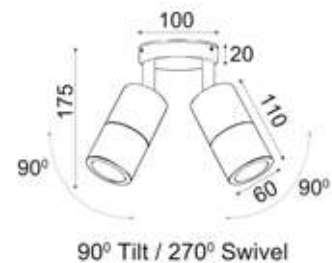
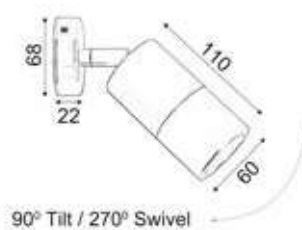
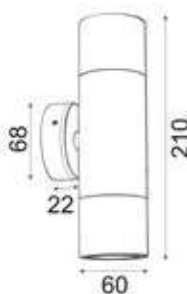

Part No.	Description	Lamp Holder	Max. Watt	Back Plate	Carton QTY
PMUDT	WALL MR16X2 (Max 20W) PILLAR UP/DN TITANIUM	2xMR16	2x20W	Ø68x22mm	1/25
PM1FT	WALL MR16 (Max 20W) PILLAR FIXED TITANIUM	1xMR16	20W	Ø68x22mm	1/25
PM1AT	WALL MR16 (Max 20W) PILLAR S/ADJ TITANIUM	1xMR16	20W	Ø68x22mm	1/25
PM2AT	WALL MR16X2 (Max 20W) PILLAR D/ADJ RND BASE TITANIUM	2xMR16	2x20W	Ø100x20mm	1/10

*To avoid disappointment and warranty problems, please ensure the IP Rating of the chosen product is relevant for the intended use.

ELANORA Exterior Lighting

- Exterior surface mounted wall & bollard lights
- Input voltage range: 220-240V AC 50/60Hz
- Housing: powder coated 304 stainless steel
- Screws & surface mounting bracket + louvres: stainless steel (Not for use inground)
- Diffuser: clear PC
- Lamp holder: E27 (Max.18W)
- Recommended CLA globes: 3U001-003 (when used with external control gear), CAN & LT series (Limited space of Ø53mm x H 145mm available)
- Globe not included
- For bollard lights, to maintain the IP rating please use circular cable in junction
- For bollard lights, for parallel and single connection we recommend using an appropriate IP68 connector (CLA Connector: CONN001 & CONN002)

**These bollards are designed for mounting on a solid surface such as a concrete path or sturdy timber decking*

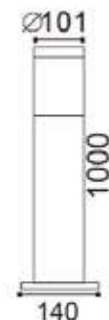
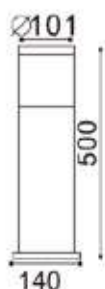

Part No.	Description	Lamp Holder	Diam	Inside Louvr	Height	Mounting Plate	Carton QTY
CLAW32	WALL ES S/M FIXED	E27	Ø101mm	Ø53 x H 145mm	265mm	Ø97mm	1/10
CLA1615SBL	BOLLARD SS304 ES BLK	E27	Ø101mm	Ø53 x H 145mm	500mm	Ø145mm	1/10
CLA1615S	BOLLARD SS304 ES	E27	Ø101mm	Ø53 x H 145mm	500mm	Ø145mm	1/10
CLA1615LBL	BOLLARD SS304 ES BLK LONG	E27	Ø101mm	Ø53 x H 145mm	1000mm	Ø145mm	1/4
CLA1615L	BOLLARD SS304 ES LONG	E27	Ø101mm	Ø53 x H 145mm	1000mm	Ø145mm	1/4

**Unless protected, not recommended for environments with harsh weather conditions or heavy rainfall. IP65 fittings recommended for such environments.*

**To avoid disappointment and warranty problems, please ensure the IP Rating of the chosen product is relevant for the intended use.*

BORDA Exterior Lighting

- Exterior surface mounted wall & bollard lights
- Input voltage range: 220-240V AC 50/60Hz
- Housing: 304 stainless steel
- Diffuser: opal PC (Ø115 x H 160mm)
- Lamp holder: E27 (Max.18W)
- Globe not included
- Recommended CLA globes: 3U001-003 (when used with external control gear), CAN & LT series
- For bollard lights, to maintain the IP rating please use circular cable in junction
- For bollard lights, for parallel and single connection we recommend using an appropriate IP68 connector (CLA Connector: CONN001 & CONN002)

**These bollards are designed for mounting on a solid surface such as a concrete path or sturdy timber decking*

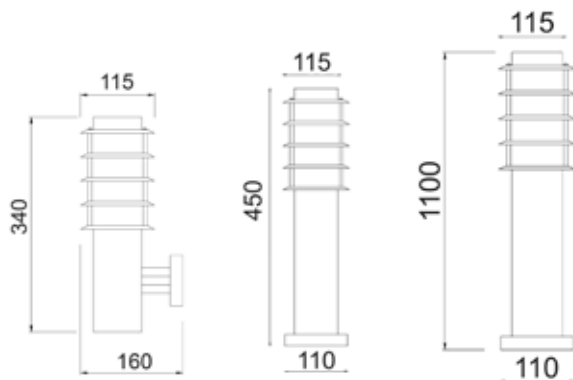

BORDA1
(Black / Wall Light)



BORDA2
(SS / Wall Light)



BORDA3
(Black / Bollard Light)



BORDA6
(SS / Bollard Light)

Part No.	Description	Diam	Inside Louvr	Height	Base	Carton QTY
BORDA1	WALL ES S/M FIXED SS304 BLACK	Ø115mm	Ø76x160mm	340mm	Ø110mm	1/10
BORDA2	WALL ES S/M FIXED SS304	Ø115mm	Ø76x160mm	340mm	Ø110mm	1/10
BORDA3	BOLLARD SHORT SS304 ES BLK	Ø115mm	Ø76x160mm	450mm	Ø110mm	1/10
BORDA4	BOLLARD SHORT SS304 ES	Ø115mm	Ø76x160mm	450mm	Ø110mm	1/10
BORDA5	BOLLARD LONG SS304 BLK ES	Ø115mm	Ø76x160mm	1000mm	Ø110mm	1/10
BORDA6	BOLLARD LONG SS304 ES	Ø115mm	Ø76x160mm	1000mm	Ø110mm	1/10

**Unless protected, not recommended for environments with harsh weather conditions or heavy rainfall. IP65 fittings recommended for such environments.*

**To avoid disappointment and warranty problems, please ensure the IP Rating of the chosen product is relevant for the intended use.*

TORRE Exterior Lighting

- Exterior surface mounted wall & bollard lights
- Input voltage range: 220-240V AC 50/60Hz
- Housing: 304 stainless steel
- Diffuser: opal PC (Ø76 x H 160mm)
- Lamp holder: E27 (Max.18W)
- Globe not included
- Recommended CLA globes: 3U001-003 (when used with external control gear), CAN & LT series
- For bollard lights, to maintain the IP rating please use circular cable in junction
- For bollard lights, for parallel and single connection we recommend using an appropriate IP68 connector (CLA Connector: CONN001 & CONN002)

**These bollards are designed for mounting on a solid surface such as a concrete path or sturdy timber decking*

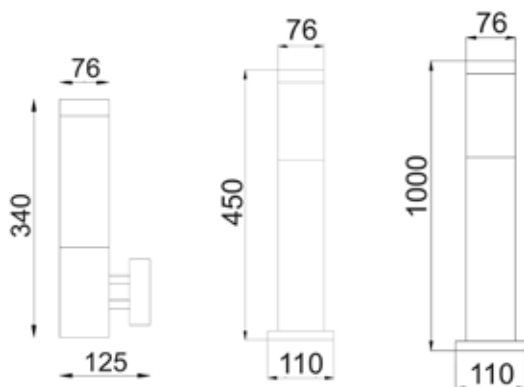

TORRE1
(Black / Wall Light)



TORRE2
(SS / Wall Light)



TORRE3
(Black / Bollard Light)



TORRE4
(SS / Bollard Light)

Part No.	Description	Diam	Height	Base	Carton QTY
TORRE1	WALL ES S/M FIXED SS304 BLACK RND	Ø76mm	340mm	Ø110mm	1/10
TORRE2	WALL ES S/M FIXED SS304 RND	Ø76mm	340mm	Ø110mm	1/10
TORRE3	BOLLARD SHORT SS304 ES BLK	Ø76mm	450mm	Ø110mm	1/10
TORRE4	BOLLARD SHORT SS304 ES	Ø76mm	450mm	Ø110mm	1/10
TORRE5	BOLLARD LONG SS304 BLACK ES	Ø76mm	1000mm	Ø110mm	1/10
TORRE6	BOLLARD LONG SS304 ES	Ø76mm	1000mm	Ø110mm	1/10

**Unless protected, not recommended for environments with harsh weather conditions or heavy rainfall. IP65 fittings recommended for such environments.*

**To avoid disappointment and warranty problems, please ensure the IP Rating of the chosen product is relevant for the intended use.*

PHARE (GU10) Exterior Lighting

- Exterior surface mounted wall & bollard lights
- Input voltage range: 110–265V AC
- Housing: aluminium /acrylic/ 316 stainless steel
- Lamp holder: GU10 (Max.35W)
- Globe not included
- IP rating: wall lamps IP65 and bollard lights IP54
- For bollard lights, to maintain the IP rating please use circular cable in junction
- For bollard lights, for parallel and single connection we recommend using an appropriate IP68 connector (CLA Connector: CONN001 & CONN002)

**These bollards are designed for mounting on a solid surface such as a concrete path or sturdy timber decking*



PHARE01G
(Wall Light)

PHARE02G
(Wall Light)

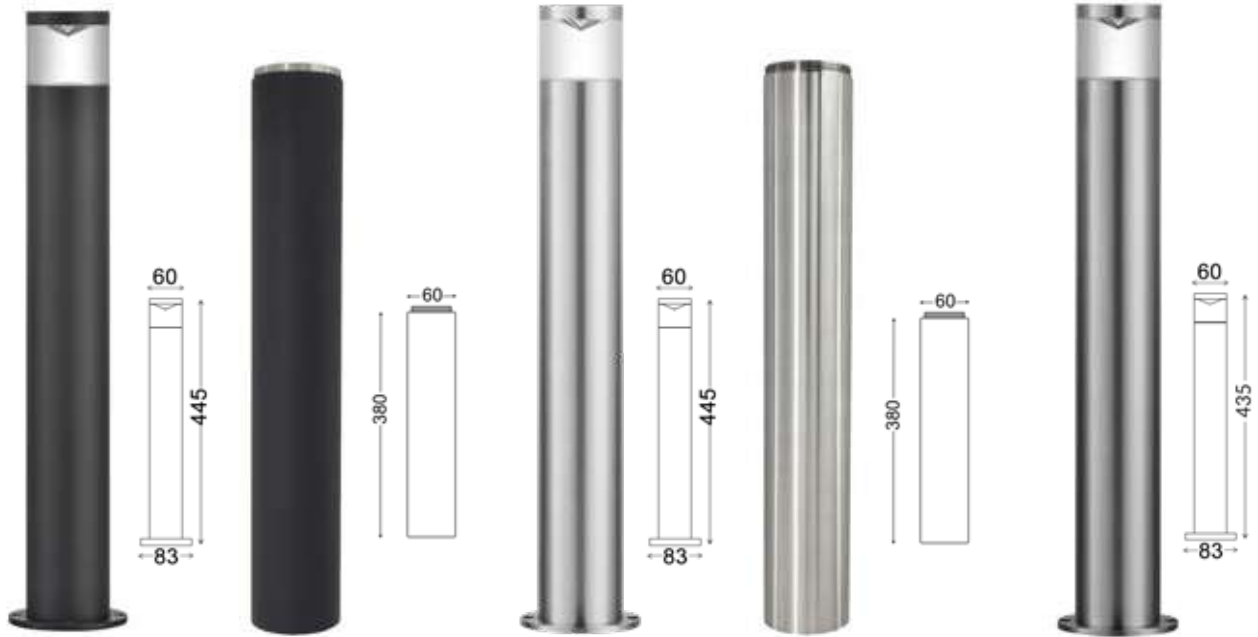
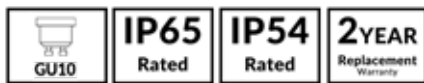

PHARE03G
(Bollard Light)

PHARE03EXT
(Bollard Extension)

PHARE04G
(Bollard Light)

PHARE04EXT
(Bollard Extension)

PHARE05G
(Bollard Light)

Part No.	Description	Lamp Holder	Max. Watt	Diam	Height	Mounting Plate	Carton QTY
PHARE01G	WALL PILLAR UP/DN MATTE BLK Anti Glare	2xGU10	35W	Ø60mm	263mm	Ø68mm	1/20
PHARE02G	WALL PILLAR UP/DN ALU TITANIUM Anodized	2xGU10	35W	Ø60mm	263mm	Ø68mm	1/20
PHARE03G	BOLLARD ALU MATTE BLK Anti Glare	1xGU10	35W	Ø60mm	445mm	Ø83mm	1/10
PHARE04G	BOLLARD ALU TITANIUM Anodized Anti Glare	1xGU10	35W	Ø60mm	445mm	Ø83mm	1/10
PHARE05G	BOLLARD SS316 35W Anti Glare	1xGU10	35W	Ø60mm	435mm	Ø83mm	1/10
BOLLARD EXTENSION							
PHARE03EXT	BOLLARD EXTENSION MATTE BLK Screw in	-	-	Ø60mm	380mm	-	1/25
PHARE04EXT	BOLLARD EXTENSION TITANIUM Screw in	-	-	Ø60mm	380mm	-	1/25

**For bollard lights, unless protected, not recommended for environments with harsh weather conditions or heavy rainfall. IP65 fittings recommended for such environments.*

**To avoid disappointment and warranty problems, please ensure the IP Rating of the chosen product is relevant for the intended use.*

PHARE (MR16) Exterior Lighting

- Exterior surface mounted wall & bollard lights
- Input voltage range: 12-24V AC/DC
- Housing: aluminium /acrylic/ 316 stainless steel
- Lamp holder: MR16 (Max.20W)
- Globe not included
- IP rating: wall lamps IP65 and bollard lights IP54
- For bollard lights, to maintain the IP rating please use circular cable in junction
- For bollard lights, for parallel and single connection we recommend using an appropriate IP68 connector (CLA Connector: CONN001 & CONN002)

**These bollards are designed for mounting on a solid surface such as a concrete path or sturdy timber decking*



PHARE01M
(Wall Light)

PHARE02M
(Wall Light)

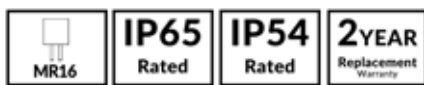

PHARE03M
(Bollard Light)



PHARE03EXT
(Bollard Extension)



PHARE04M
(Bollard Light)



PHARE04EXT
(Bollard Extension)



PHARE05M
(Bollard Light)

Part No.	Description	Lamp Holder	Max. Watt	Diam	Height	Mounting Plate	Carton QTY
PHARE01M	WALL PILLAR UP/DN MATTE BLK Anti Glare	2xMR16	20W	Ø60mm	263mm	Ø68mm	1/20
PHARE02M	WALL PILLAR UP/DN ALU TITANIUM Anodized	2xMR16	20W	Ø60mm	263mm	Ø68mm	1/20
PHARE03M	BOLLARD ALU MATTE BLK Anti Glare	1xMR16	20W	Ø60mm	445mm	Ø83mm	1/10
PHARE04M	BOLLARD ALU TITANIUM Anodized Anti Glare	1xMR16	20W	Ø60mm	445mm	Ø83mm	1/10
PHARE05M	BOLLARD SS316 35W Anti Glare	1xMR16	20W	Ø60mm	435mm	Ø83mm	1/10
BOLLARD EXTENSION							
PHARE03EXT	BOLLARD EXTENSION MATTE BLK Screw in	-	-	Ø60mm	380mm	-	1/25
PHARE04EXT	BOLLARD EXTENSION TITANIUM Screw in	-	-	Ø60mm	380mm	-	1/25

**For bollard lights, unless protected, not recommended for environments with harsh weather conditions or heavy rainfall. IP65 fittings recommended for such environments.*

**To avoid disappointment and warranty problems, please ensure the IP Rating of the chosen product is relevant for the intended use.*

PORTUS Exterior Lighting



PORTUS1FLC
(Bollard Light)

PORTUS1FLSS
(Bollard Light)

- Exterior bollard / spike lights
- Input voltage: 12-14V AC/DC 50/60Hz
- Nominal current: 150mA
- Material: 316 stainless steel or solid copper
- PORTUS1SP spike material: brass
- LED chips: 12pcs 2835 LED
- CRI: 75
- Cable length: 47mm
- Ambient temperature: -40 to 85°C
- For bollard lights, to maintain the IP rating please use circular cable in junction
- For bollard lights, for parallel and single connection we recommend using an appropriate IP68 connector (CLA Connector: CONN001 & CONN002)

**These bollards are designed for mounting on a solid surface such as a concrete path or sturdy timber decking*



Tested & Recommended drivers:

DRIV1 / OTTER1 / CLA111011 / CLA113011 / CLA115011 / CLA1115011

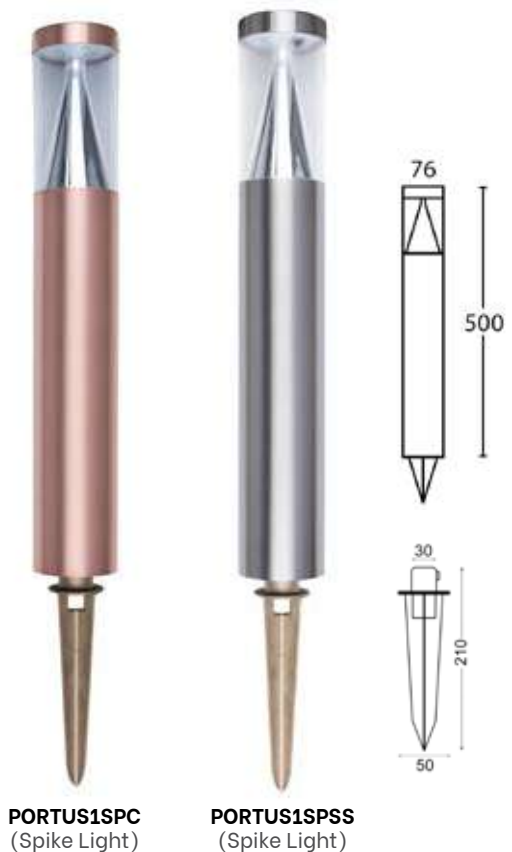

PORTUS1SPC
(Spike Light)

PORTUS1SPSS
(Spike Light)

Part No.	Description	Kelvin	Lumens	Watt	CRI	Dimensions	Mounting Plate	Carton QTY
PORTUS1FLC	BOLLARD LED 12V COP 3000K	3000K	620LM	6W	75	Ø76x500mm	Ø110mm	1/10
PORTUS1FLSS	BOLLARD LED 12V SS316 3000K	3000K	620LM	6W	75	Ø76x500mm	Ø110mm	1/10
PORTUS1SPC	SPIKE LED 12V COP 3000K	3000K	620LM	6W	75	Ø76x500mm	-	1/10
PORTUS1SPSS	SPIKE LED 12V SS316 3000K	3000K	620LM	6W	75	Ø76x500mm	-	1/10

**To avoid disappointment and warranty problems, please ensure the IP Rating of the chosen product is relevant for the intended use.*

SHU Exterior Lighting

- Exterior LED surface mounted wall & bollard lights
- Input voltage range: 100-240V AC 50/60Hz
- Inbuilt driver output range: 18-42V
- Housing: powder coated aluminium
- Mounting bracket: aluminium
- LED chip: 2pcs 5050
- Power factor: >0.5
- Ambient temperature: -20 to 50°C
- Suitable for 2-way switching
- Suitable for use with PIR or Microwave sensors
- For bollard lights, to maintain the IP rating please use circular cable in junction
- For bollard lights, for parallel and single connection we recommend using an appropriate IP68 connector (CLA Connector: CONN001 & CONN002)

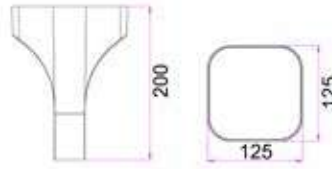

SHU1
(Wall Light)

**These bollards are designed for mounting on a solid surface such as a concrete path or sturdy timber decking*

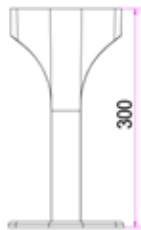

SHU2

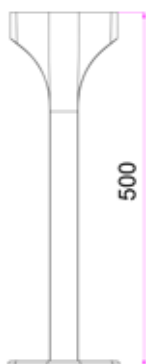
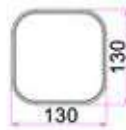

SHU3

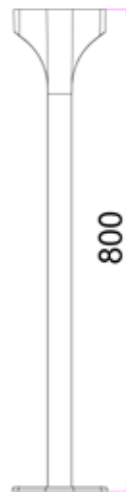

SHU4



SHU2
(Bollard Light)



SHU3
(Bollard Light)



SHU4
(Bollard Light)

Part No.	Description	Kelvin	Lumens	Watt	PF	CRI	Dimensions	Mounting Plate	Carton QTY
SHU1	WALL LED S/M Dark Grey 2 way	3000K	540LM	11W	>0.5	80	125x125x200mm		1/8
SHU2	BOLLARD LED Dark Grey 2 way	3000K	540LM	11W	>0.5	80	H 300mm	130x130mm	1/8
SHU3	BOLLARD LED Dark Grey 2 way	3000K	540LM	11W	>0.5	80	H 500mm	130x130mm	1/4
SHU4	BOLLARD LED Dark Grey 2 way	3000K	540LM	11W	>0.5	80	H 800mm	130x130mm	1/4

**To avoid disappointment and warranty problems, please ensure the IP Rating of the chosen product is relevant for the intended use.*

GEB Exterior Lighting

- Exterior LED surface mounted wall & bollard lights
- Input voltage rang: 100–240V 50/60Hz
- Output voltage range: 18–42V
- Material: aluminium post, die-cast & PC
- LED chips: 12pcs 3030
- Power factor: >0.5
- Ambient temperature: -20 to 50°C
- Not suitable for dimming
- Suitable for 2 way switching
- Suitable for use with PIR or Microwave sensors
- For bollard lights, to maintain the IP rating please use circular cable in junction
- For bollard lights, for parallel and single connection we recommend using an appropriate IP68 connector (CLA Connector: CONN001 & CONN002)

**These bollards are designed for mounting on a solid surface such as a concrete path or sturdy timber decking*



GEB1
(Wall Light)



GEB3
(Bollard Light)



GEB2
(Bollard Light)

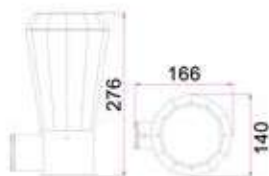

GEB1

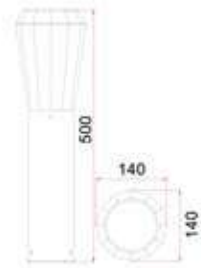

GEB2

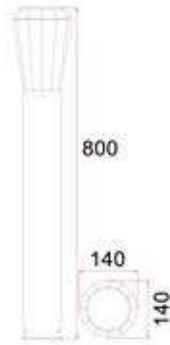

GEB3

GEB2 & 3 Pole base OD: 90mm ID: 29mm

Part No.	Description	Kelvin	Lumens	Watt	PF	CRI	Dimensions	Mounting Plate	Carton QTY
GEB1	WALL LED S/M Dark Grey Tapered	3000K	580LM	13W	>0.5	>80	L 276 x W 140mm		1/8
GEB2	BOLLARD LED Dark Grey Tapered	3000K	580LM	13W	>0.5	>80	H 500mm	Ø90mm	1/4
GEB3	BOLLARD LED Dark Grey Tapered	3000K	580LM	13W	>0.5	>80	H 800mm	Ø90mm	1/4

**Unless protected, not recommended for environments with harsh weather conditions or heavy rainfall. IP65 fittings recommended for such environments.*

**To avoid disappointment and warranty problems, please ensure the IP Rating of the chosen product is relevant for the intended use.*

- Exterior LED surface mounted wall & bollard lights
- Input voltage range: 100-240V AC 50/60Hz
- Constant current driver included
- Material: double anti-corrosion powder coated high-pressure cast aluminium & anti aging UV protected PC diffuser
- All products have diffusers both front & back
- Comes with stainless steel screws
- LED chips: 2835 LED
- Power factor: >0.5
- Ambient temperature: -20 to 50°C
- Not suitable for dimming
- Suitable for 2-way switching
- Suitable for use with PIR or Microwave sensors
- For bollard lights, to maintain the IP rating please use circular cable in junction
- For bollard lights, for parallel and single connection we recommend using an appropriate IP68 connector (CLA Connector: CONN001 & CONN002)

**These bollards are designed for mounting on a solid surface such as a concrete path or sturdy timber decking*

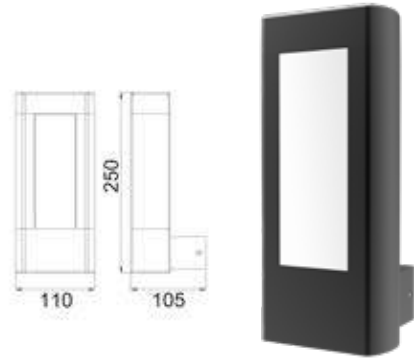

AMUN1
(Wall Light)

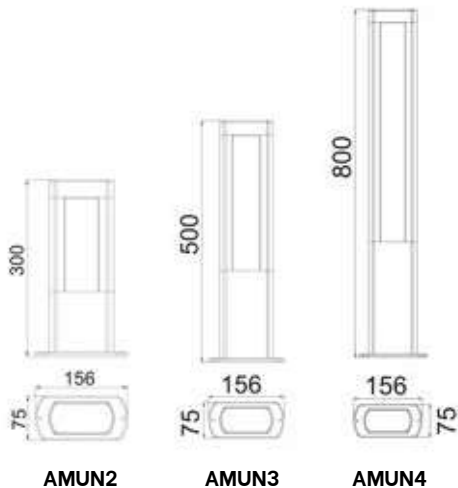

AMUN2

AMUN3

AMUN4



AMUN2
(Bollard Light)

AMUN3
(Bollard Light)

AMUN4
(Bollard Light)

Part No.	Description	Kelvin	Lumens	Watt	PF	CRI	Dimensions	Mounting Plate	Carton QTY
AMUN1	WALL LED S/M Matte Black Rect	3000K	560LM	10w	>0.5	>80	L 250 x W 110mm	-	1/6
AMUN2	BOLLARD LED Matte Black Rect	3000K	560LM	10w	>0.5	>80	H 300mm	156x75mm	1/8
AMUN3	BOLLARD LED Matte Black	3000K	645LM	12.5w	>0.5	>80	H 500mm	156x75mm	1/4
AMUN4	BOLLARD LED Matte Black	3000K	756LM	12.5w	>0.5	>80	H 800mm	156x75mm	1/4

**Unless protected, not recommended for environments with harsh weather conditions or heavy rainfall. IP65 fittings recommended for such environments.*

**To avoid disappointment and warranty problems, please ensure the IP Rating of the chosen product is relevant for the intended use.*

HATHOR Exterior Lighting

- Exterior LED surface mounted wall & bollard lights
- Input voltage range: 100-240V AC 50/60Hz
- Inbuilt constant current driver included
- Driver output voltage range: 18-42V
- Housing & heatsink: powder coated-aluminium
- Diffuser: PC
- HATHOR1 back plate: PC
- HATHOR2 & 3 surface mounting plate: die cast aluminium
- Power factor: >0.5
- Ambient temperature: -20 to 50°C
- Not suitable for use with dimmers
- Suitable for 2-way switching
- Suitable for use with PIR or Microwave sensors
- For bollard lights, to maintain the IP rating please use circular cable in junction
- For bollard lights, for parallel and single connection we recommend using an appropriate IP68 connector (CLA Connector: CONN001 & CONN002)

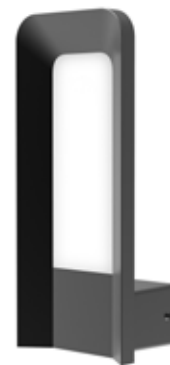

HATHOR1
(Wall Light)



HATHOR3
(Bollard Light)



HATHOR2
(Bollard Light)

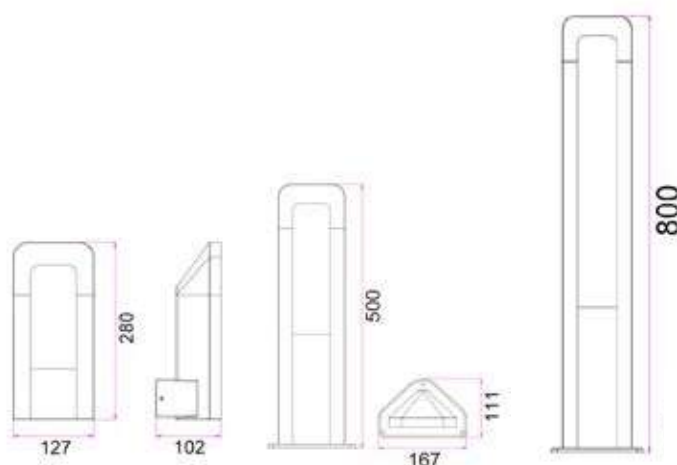

HATHOR1

HATHOR2

HATHOR3

Part No.	Description	Kelvin	Lumens	Watt	PF	CRI	Dimensions	Mounting Plate	Carton QTY
HATHOR1	WALL LED DARK GREY S/M	3000K	175.58LM	9W	>0.5	>80	280x127x102mm		1/8
HATHOR2	BOLLARD LED DARK GREY	3000K	242.19LM	13W	>0.5	>80	H 500mm	167x111mm	1/4
HATHOR3	BOLLARD LED DARK GREY	3000K	242.19LM	13W	>0.5	>80	H 800mm	167x111mm	1/4

**Unless protected, not recommended for environments with harsh weather conditions or heavy rainfall. IP65 fittings recommended for such environments.*

**To avoid disappointment and warranty problems, please ensure the IP Rating of the chosen product is relevant for the intended use.*

SETH Exterior Lighting

- Exterior LED surface mounted wall & bollard lights
- Input voltage range: 100–240V AC 50/60Hz
- Constant current driver included
- Material: double anti-corrosion powder coated high-pressure cast aluminium & anti aging UV protected PC diffuser
- LED chips: 8pcs 3030 LED
- Power factor: >0.5
- Ambient temperature: -20 to 50°C
- Not suitable for dimming
- Suitable for 2-way switching
- Suitable for use with PIR or Microwave sensors
- For bollard lights, to maintain the IP rating please use circular cable in junction
- For bollard lights, for parallel and single connection we recommend using an appropriate IP68 connector (CLA Connector: CONN001 & CONN002)

**These bollards are designed for mounting on a solid surface such as a concrete path or sturdy timber decking*



SETH1
(Wall Light)

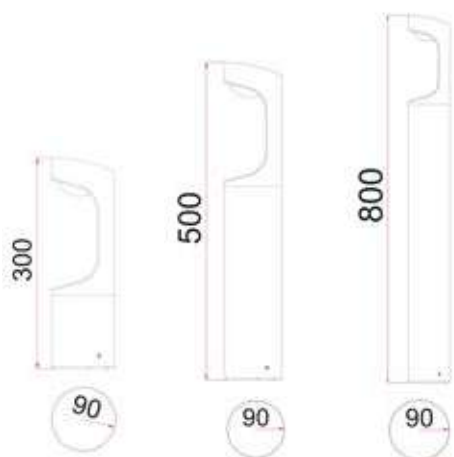

SETH2

SETH3

SETH4



SETH2
(Bollard Light)



SETH3
(Bollard Light)



SETH4
(Bollard Light)

Part No.	Description	Kelvin	Lumens	Watt	PF	CRI	Dimensions	Mounting Plate	Carton QTY
SETH1	WALL LED 240V S/M Matte Black	3000K	428.76LM	9W	>0.5	>80	L 272 x W 90mm		1/8
SETH2	BOLLARD LED Matte Black	3000K	428.76LM	9W	>0.5	>80	H 300mm	Ø90mm	1/9
SETH3	BOLLARD LED Matte Black	3000K	428.76LM	9W	>0.5	>80	H 500mm	Ø90mm	1/9
SETH4	BOLLARD LED Matte Black	3000K	428.76LM	9W	>0.5	>80	H 800mm	Ø90mm	1/9

**Unless protected, not recommended for environments with harsh weather conditions or heavy rainfall. IP65 fittings recommended for such environments.*

**To avoid disappointment and warranty problems, please ensure the IP Rating of the chosen product is relevant for the intended use.*

HORUS Exterior Lighting

- Exterior LED surface mounted wall & bollard lights
- Input voltage range: 100-240V AC 50/60Hz
- Constant current driver included
- Material: double anti-corrosion powder coat high-pressure cast aluminium & anti aging UV protected PC diffuser
- Comes with stainless steel screws
- LED chips: 8pcs 3030 LED
- Power factor: >0.5
- Ambient temperature: -20 to 50°C
- Not suitable for dimming
- Suitable for 2-way switching
- Suitable for use with PIR or Microwave sensors
- For bollard lights, to maintain the IP rating please use circular cable in junction
- For bollard lights, for parallel and single connection we recommend using an appropriate IP68 connector (CLA Connector: CONN001 & CONN002)

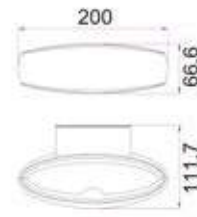

HORUS1
(Wall Light)

**These bollards are designed for mounting on a solid surface such as a concrete path or sturdy timber decking*

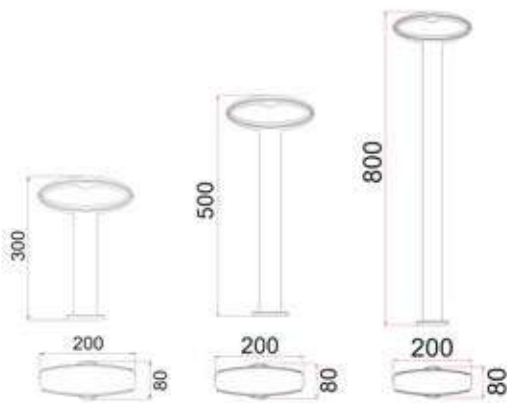

HORUS2

HORUS3

HORUS4



HORUS2
(Bollard Light)

HORUS3
(Bollard Light)

HORUS4
(Bollard Light)

Part No.	Description	Kelvin	Lumens	Watt	PF	CRI	Dimensions	Carton QTY
HORUS1	WALL LED S/M Matte Black Crescent	3000K	364LM	9W	>0.5	>80	L 200x W66.6mm	1/8
HORUS2	BOLLARD LED Matte Black Open Oval	3000K	368LM	9W	>0.5	>80	H 300mm	1/8
HORUS3	BOLLARD LED Matte Black Open Oval	3000K	350LM	9W	>0.5	>80	H 500mm	1/4
HORUS4	BOLLARD LED Matte Black Open Oval	3000K	355LM	9W	>0.5	>80	H 800mm	1/4

**Unless protected, not recommended for environments with harsh weather conditions or heavy rainfall. IP65 fittings recommended for such environments.*

**To avoid disappointment and warranty problems, please ensure the IP Rating of the chosen product is relevant for the intended use.*

- Exterior LED surface mounted bollard lights
- Input voltage range: 100–240V AC 50/60Hz
- Inbuilt driver output range: 18–42V
- Housing: powder coated aluminium
- Heatsink & mounting bracket: aluminium
- LED chip: 1pc 7070
- Power factor: >0.5
- Ambient temperature: -20 to 50°C
- Not for use inground
- Not suitable for dimming
- Suitable for 2-way switching
- Suitable for use with PIR or Microwave sensors
- For bollard lights, to maintain the IP rating please use circular cable in junction
- For bollard lights, for parallel and single connection we recommend using an appropriate IP68 connector (CLA Connector: CONN001 & CONN002)

**These bollards are designed for mounting on a solid surface such as a concrete path or sturdy timber decking*



SEKER1 (Bollard Light) **SEKER2** (Bollard Light) **SEKER3** (Bollard Light)

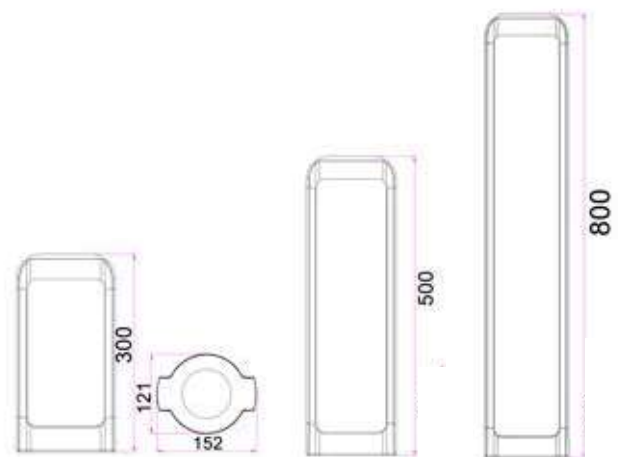

SEKER1 **SEKER2** **SEKER3**

Part No.	Description	Kelvin	Lumenes	Watt	PF	CRI	Dimensions	Mounting Plate	Carton QTY
SEKER1	BOLLARD LED Dark Grey Short	3000K	530LM	13w	>0.5	80	H 300mm	152x121mm	1/8
SEKER2	BOLLARD LED Dark Grey med	3000K	530LM	13w	>0.5	80	H 500mm	152x121mm	1/4
SEKER3	BOLLARD LED Dark Grey long	3000K	530LM	13w	>0.5	80	H 800mm	152x121mm	1/4

**To avoid disappointment and warranty problems, please ensure the IP Rating of the chosen product is relevant for the intended use.*

BOL Exterior Lighting

- Exterior LED surface mounted bollard lights
- Input voltage range: 100-240V AC 50/60Hz
- Inbuilt driver output voltage range: 18-42V
- Housing: powder coated aluminium
- Heatsink & mounting bracket: aluminium
- LED chip: 1pc 7070
- Power factor: >0.5
- Ambient temperature: -20 to 50°C
- Not for use inground
- Not suitable for dimming
- Suitable for 2-way switching
- For bollard lights, to maintain the IP rating please use circular cable in junction
- For bollard lights, for parallel and single connection we recommend using an appropriate IP68 connector (CLA Connector: CONN001 & CONN002)

**These bollards are designed for mounting on a solid surface such as a concrete path or sturdy timber decking*



BOL1A



BOL2A



BOL3A



BOL4A

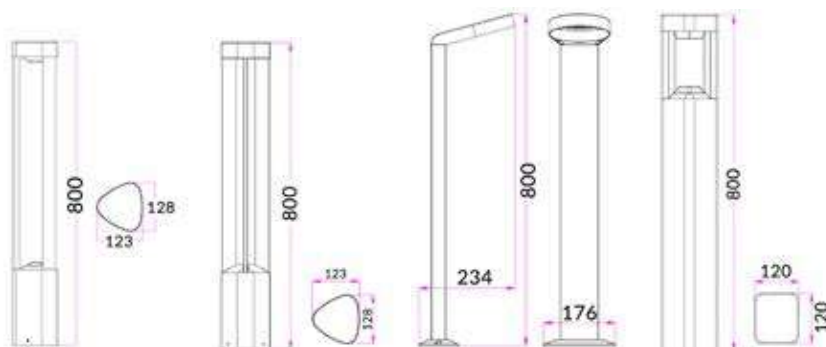

Part No.	Description	Kelvin	Lumens	Watt	Beam Angle	PF	CRI	Height	Mounting Plate	Carton QTY
BOL1A	BOLLARD LED GREY 3 SECTIONS	3000K	216LM	7W	197°	>0.5	>80	800mm		1/4
BOL2A	BOLLARD LED GREY TRIANGULAR	3000K	120LM	7W	106°	>0.5	>80	800mm	see line drawings above	1/4
BOL3A	BOLLARD LED GREY HOOP	3000K	211LM	7W	119°	>0.5	>80	800mm		1/4
BOL4A	BOLLARD LED GREY SQUARE	3000K	193LM	7W	343°	>0.5	>80	800mm		1/4

**Unless protected, not recommended for environments with harsh weather conditions or heavy rainfall. IP65 fittings recommended for such environments.*

**To avoid disappointment and warranty problems, please ensure the IP Rating of the chosen product is relevant for the intended use.*



SPM1ALC
(Copper)



SPM2ALC
(Copper)



SPM1ALSS
(316 Stainless steel)



SPM2ALSS
(316 Stainless steel)



SPM1ALBL
(Aluminium black)



SPM2ALBL
(Aluminium black)

- Exterior garden spike lights
- Input voltage range: 12–25V AC/DC
- Material: solid copper/ 316 stainless steel/ aluminium
- Lamp holder: MR16 (Max.20W)
- Globes not included
- Spike length: 1000mm
- Cable included (L 900mm)
- External control gear required
- For bollard lights, to maintain the IP rating please use circular cable in junction
- For bollard lights, for parallel and single connection we recommend using an appropriate IP68 connector (CLA Connector: CONN001 & CONN002)

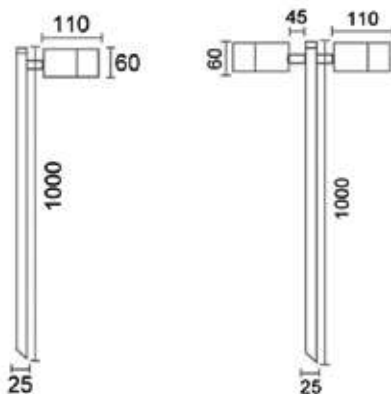

Part No.	Description	Lamp Holder	Max. Watt	Height	Barrel	Carton QTY
SPM1ALBL	SPIKE MR16 12V S/ADJ AL BLK L1000mm	1xMR16	20W	1000mm	110xØ60mm	1/10
SPM1ALC	SPIKE MR16 12V S/ADJ COP L1000mm	1xMR16	20W	1000mm	110xØ60mm	1/10
SPM1ALSS	SPIKE MR16 12V S/ADJ SS316 L1000mm	1xMR16	20W	1000mm	110xØ60mm	1/10
SPM2ALBL	SPIKE MR16 12V D/ADJ AL BLK L1000mm	2xMR16	20W	1000mm	110xØ60mm	1/10
SPM2ALC	SPIKE MR16 12V D/ADJ COP L1000mm	2xMR16	20W	1000mm	110xØ60mm	1/10
SPM2ALSS	SPIKE MR16 12V D/ADJ SS316 L1000mm	2xMR16	20W	1000mm	110xØ60mm	1/10

*To avoid disappointment and warranty problems, please ensure the IP Rating of the chosen product is relevant for the intended use.



SPMSBL
(Aluminium black)



SPMSC
(Copper)

- Exterior garden spike lights
- Input voltage range: 12-25V AC/DC
- Material: aluminium, copper or 316 stainless steel
- Lamp holder: MR16 (Max.20W)
- Globes not included
- Cable included (L 2000mm)
- External control gear required
- For bollard lights, to maintain the IP rating please use circular cable in junction
- For bollard lights, for parallel and single connection we recommend using an appropriate IP68 connector (CLA Connector: CONN001 & CONN002)



SPMSSS
(316 Stainless steel)



SPMST
(Aluminium Titanium)

90° Tilt/ 270° Swivel

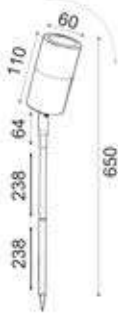

SPMS

90° Tilt/ 270° Swivel

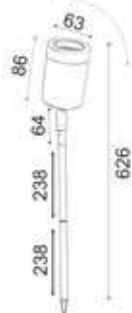

SPMS 86



SPMSBL86
(Aluminium black)



SPMSSS86
(316 Stainless steel)

Part No.	Description	Lamp Holder	Max. Watt	Height	Barrel	Carton QTY
SPMSBL	SPIKE MR16 12V S/ADJ BLK L650mm	1xMR16	20W	650mm	110xØ60mm	1/20
SPMSC	SPIKE MR16 12V S/ADJ COP L650mm	1xMR16	20W	650mm	110xØ60mm	1/10
SPMSSS	SPIKE MR16 12V S/ADJ 316 SS L650mm	1xMR16	20W	650mm	110xØ60mm	1/10
SPMST	SPIKE MR16 12V S/ADJ TITANIUM L650mm	1xMR16	20W	650mm	110xØ60mm	1/20
SPMSBL86	SPIKE MR16 S/ADJ BLK L626mm	1xMR16	20W	626mm	86xØ63mm	1/20
SPMSSS86	SPIKE MR16 S/ADJ 316 SS L626mm	1xMR16	20W	626mm	86xØ63mm	1/10

*To avoid disappointment and warranty problems, please ensure the IP Rating of the chosen product is relevant for the intended use.

COOLIE Exterior Lighting

- Exterior garden spike light
- Input voltage range: 12–25V
- Material: solid brass / aluminium
- Colour: rustic antique brass / matte black
- Lamp holder: G4 (Max.20W)
- Globe not included
- Flex: 920mm
- External control gear required
- For bollard lights, to maintain the IP rating please use circular cable in junction
- For bollard lights, for parallel and single connection we recommend using an appropriate IP68 connector (CLA Connector: CONN001 & CONN002)



Tested & Recommended CLA Globes:

- CLAESH12V14W
- CLAL1.58 B / G / R / Y
- CLAG4L3WW / CW
- CLAG4L15WW / CW



Part No.	Description	Lamp Holder	Max. Watt	Diam	Total Length	Spike L	Carton QTY
COOLIE01	SPIKE G4 12V FIXED Rustic Brass	1xG4	20W	Ø175mm	800mm	220mm	1/10
COOLIE02	SPIKE G4 12V FIXED MATT BLK	1xG4	20W	Ø175mm	800mm	220mm	1/10

**Unless protected, not recommended for environments with harsh weather conditions or heavy rainfall. IP65 fittings recommended for such environments.*

**To avoid disappointment and warranty problems, please ensure the IP Rating of the chosen product is relevant for the intended use.*

KOLEC Exterior Lighting

- Exterior LED garden spike light
- Input voltage: 12V
- Material: die cast aluminium
- Spike material: PC
- Diffuser: clear glass
- Adjustable up/down head : 10-80°
- LED chip: 1 COB
- Power factor: >0.5
- CRI: >80
- Flex only: 1m
- Ambient temp: -20 to 50°C
- Suitable for 2 way switching
- Suitable for use with Microwave or PIR sensors
- Constant voltage driver required.
- Recommended CLA 12V waterproof LED drivers
- For bollard lights, to maintain the IP rating please use circular cable in junction
- For bollard lights, for parallel and single connection we recommend using an appropriate IP68 connector (CLA Connector: CONN001 & CONN002)



KOLEC1



Part No.	Description	Colour	Kelvin	Lumens	Watt	Carton QTY
KOLEC1	SPIKE/HOOD (Dark Grey) Adj 12V L314mm	Dark Grey	3000K	930LM	13W	1/12

KAM

- Exterior garden spike lights
- Input voltage: 12V
- Material: powder coated aluminium
- Lamp holder: MR16 (Max.20W)
- Globe not included
- Flex: 1000mm
- External control gear required
- For bollard lights, to maintain the IP rating please use circular cable in junction
- For bollard lights, for parallel and single connection we recommend using an appropriate IP68 connector (CLA Connector: CONN001 & CONN002)



KAM01



Part No.	Description	Colour	Lamp Holder	Max. Watt	Carton QTY
KAM01	SPIKE/HOOD (Dark Grey) 20W MR16 IP65	Dark Grey	1xMR16	20W	1/12

*To avoid disappointment and warranty problems, please ensure the IP Rating of the chosen product is relevant for the intended use.

PHARE Exterior Lighting

- Exterior garden spike lights
- Input voltage range: 12-25V
- Housing: aluminium & acrylic
- Lamp holder: MR16 (Max.20W)
- Globe not included
- Flex: 1100mm
- Anti glare
- External control gear required
- For bollard lights, to maintain the IP rating please use circular cable in junction
- For bollard lights, for parallel and single connection we recommend using an appropriate IP68 connector (CLA Connector: CONN001 & CONN002)

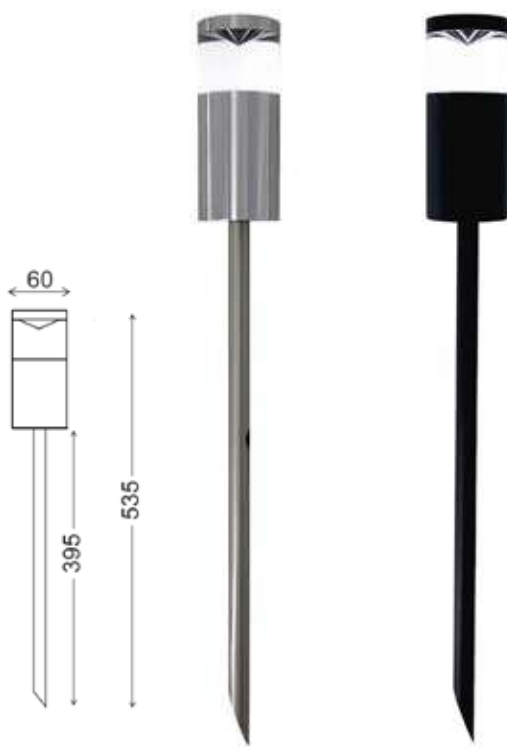

PHARE06M
(Titanium Anodized)

PHARE07M
(Black)

Part No.	Description	Lamp Holder	Max. Watt	Barrel Diam	Barrel Length	Spike L	Carton QTY
PHARE06M	SPIKE MR16 12V FIXED Titanium Anodized	1xMR16	20W	Ø60mm	140mm	400mm	1/10
PHARE07M	SPIKE MR16 12V FIXED Powder Coated BLK	1xMR16	20W	Ø60mm	140mm	400mm	1/10

POND/SPOT LIGHT

- Surface mount adjustable pond/ spot light
- Input voltage: 12-24V
- Material: 316 stainless steel
- Lamp holder: MR16 (Max.35W)
- Globe not included
- IP rating: IP68
- Flex: 900mm
- For bollard lights, to maintain the IP rating please use circular cable in junction
- For bollard lights, for parallel and single connection we recommend using an appropriate IP68 connector (CLA Connector: CONN001 & CONN002)



SMIP68ASS

Part No.	Description	Colour	Lamp Holder	Max. Watt	Carton QTY
SMIP68ASS	SPOT 12V MR16 35W S/M SS316 (5mm tempered glass)	316 Stainless steel	1xMR16	35W	1/10

*To avoid disappointment and warranty problems, please ensure the IP Rating of the chosen product is relevant for the intended use.



DECK01-02



DECK03-04

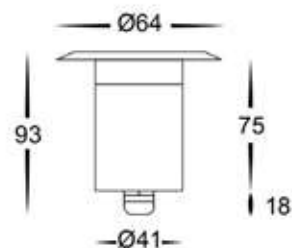

- Exterior LED deck lights
- Input voltage range: 9-14V DC
- Faceplate: 316 stainless steel / copper
- Housing: aluminium
- Diffuser: PVC
- Flex: 900mm
- LED chip: 1pc Brightlux 45mil
- Power factor: 0.98
- CRI: 80
- Ambient temperature: -20 to 50°C
- Not suitable for dimming
- External control gear required
- IP68 connectors must be used
- For bollard lights, to maintain the IP rating please use circular cable in junction
- For bollard lights, for parallel and single connection we recommend using an appropriate IP68 connector (CLA Connector: CONN001 & CONN002)



Tested & Recommended Drivers:

Indoor drivers: DRIV1 / CLADR12WFP

Weather Proof drivers: OTTER1 / CLA111011 / CLA113011 / CLA115011 / CLA1110011 / CLA1120011 / OTTER5

Part No.	Description	Colour	Kelvin	Lumens	Watt	CRI	Cut out	Carton QTY
DECK01	DECK LIGHT LED 3000K 12V 3W 43MM	Stainless Steel	3000K	160LM	3W	80	Ø43mm	1/50
DECK02	DECK LIGHT LED 6000K 12V 3W 43MM	Stainless Steel	6000K	180LM	3W	80	Ø43mm	1/50
DECK03	DECK LIGHT LED 3000K 12V 3W 43MM	Natural Copper	3000K	160LM	3W	80	Ø43mm	1/50
DECK04	DECK LIGHT LED 6000K 12V 3W 43MM	Natural Copper	6000K	180LM	3W	80	Ø43mm	1/50

*To avoid disappointment and warranty problems, please ensure the IP Rating of the chosen product is relevant for the intended use.

GU10 Inground Up Lights Exterior Lighting

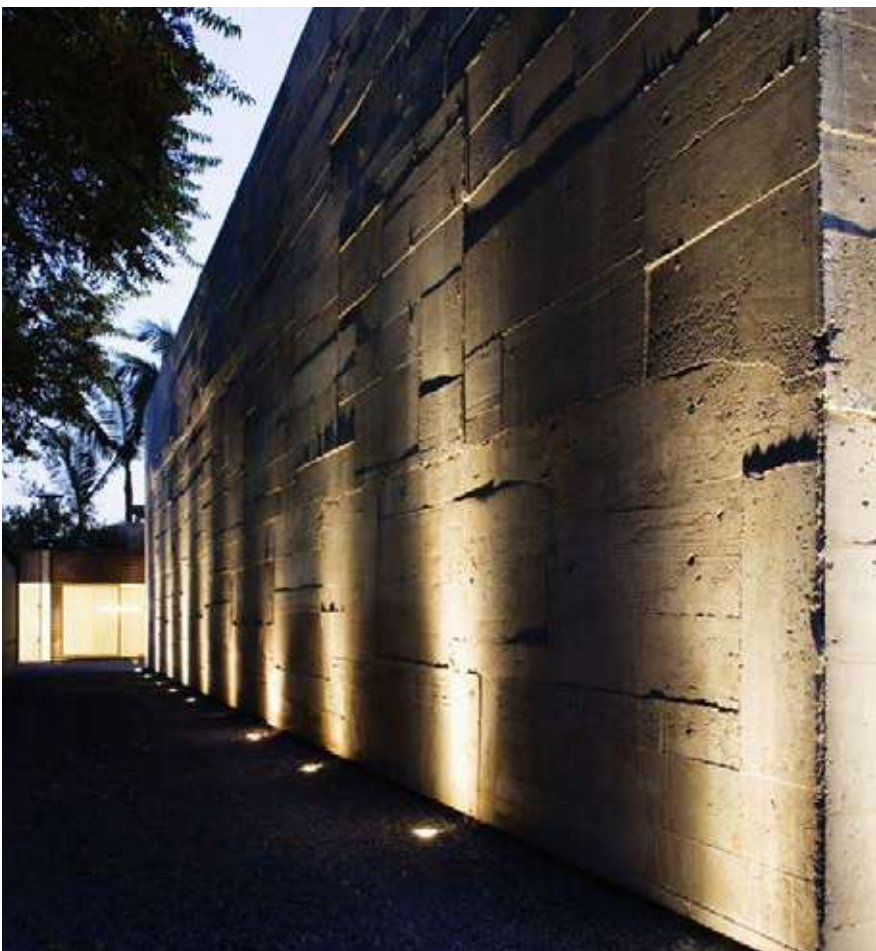

IGGLSQSS



IGGLSS

- Exterior recessed inground up lights
- Input voltage : 240V AC
- Faceplate: 316 stainless steel
- Housing: aluminium
- Lamp holder: GU10 (Max.35W)
- Globe not included
- Plastic sleeve included (must be installed)
- Fitting slides and screws into sleeve
- Cable included (L950mm)
- 8mm tempered glass, max load capacity 600kg
- For bollard lights, to maintain the IP rating please use circular cable in junction
- For bollard lights, for parallel and single connection we recommend using an appropriate IP68 connector (CLA Connector: CONN001 & CONN002)

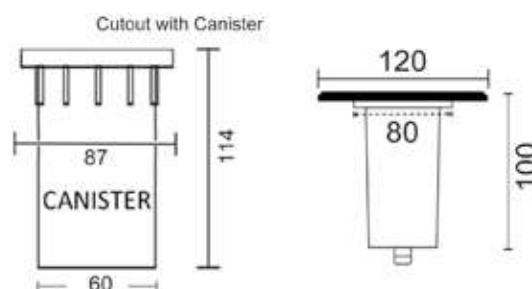

Part No.	Description	Colour	Lamp Holder	Max. Watt	Faceplate	Carton QTY
IGGLSQSS	INGROUND / WALL GU10 SS316 LGE SQ	316 SS clear anodized	1xGU10	35W	120x120mm	1/10
IGGLSS	INGROUND / WALL GU10 SS316 LGE RND	316 SS clear anodized	1xGU10	35W	Ø120mm	1/10

**To avoid disappointment and warranty problems, please ensure the IP Rating of the chosen product is relevant for the intended use.*

MR16 Inground Up Lights Exterior Lighting

- Exterior recessed inground up lights
- Input voltage range: 12–25V DC / AC
- External Control Gear Required
- Housing: aluminium
- Faceplate: 316 Stainless steel, solid copper or solid brass
- Lamp holder: MR16 (Max.20W)
- Globe not included
- Plastic sleeve included (must be installed)
- Fitting slides and screws into sleeve
- Cable included (L950mm)
- 8mm tempered glass, max load capacity 600kg
- For bollard lights, to maintain the IP rating please use circular cable in junction
- For bollard lights, for parallel and single connection we recommend using an appropriate IP68 connector (CLA Connector: CONN001 & CONN002)



IGMLSQBR
(Solid Brass)



IGMLBR
(Solid brass)



IGMLSQC
(Solid copper)



IGMLC
(Solid copper)

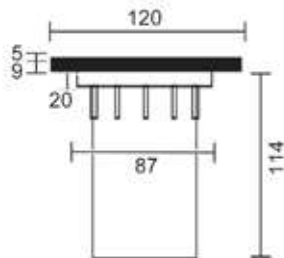

IGMLSQSS
(316 Stainless steel)



IGMLSS
(316 Stainless steel)

Part No.	Description	Colour	Lamp Holder	Max. Watt	Faceplate	Carton QTY
IGMLBR	INGROUND / WALL MR16 12V Brass LGE RND	Aged Brass	MR16	20W	Ø120mm	1/20
IGMLC	INGROUND / WALL MR16 12V COP LGE RND	Polished Copper	MR16	20W	Ø120mm	1/20
IGMLSS	INGROUND / WALL MR16 12V SS316 LGE RND	316 SS clear anodized	MR16	20W	Ø120mm	1/20
IGMLSQBR	INGROUND / WALL MR16 12V Brass LGE SQ	Aged Brass	MR16	20W	120x120mm	1/20
IGMLSQC	INGROUND / WALL MR16 12V COP LGE SQ	Polished Copper	MR16	20W	120x120mm	1/20
IGMLSQSS	INGROUND / WALL MR16 12V SS316 LGE SQ	316 SS clear anodized	MR16	20W	120x120mm	1/20

*To avoid disappointment and warranty problems, please ensure the IP Rating of the chosen product is relevant for the intended use.

MR16 Inground Up Lights (Small Faceplate) Exterior Lighting



IGM1SS



IGM2SS



IGM3SS



IGM4SS

- Exterior recessed inground up lights
- Input voltage range: 12-25V DC / AC
- External Control Gear Required
- Housing: 316 Stainless steel
- Faceplate: 316 Stainless steel
- Lamp holder: MR16 (Max.20W)
- Globe not included
- Plastic sleeve included (must be used when installing in concrete)
- Fitting slides into sleeve and remains unattached
- Cable included (L950mm)
- 4mm tempered glass, max load capacity 100kg
- For bollard lights, to maintain the IP rating please use circular cable in junction
- For bollard lights, for parallel and single connection we recommend using an appropriate IP68 connector (CLA Connector: CONN001 & CONN002)

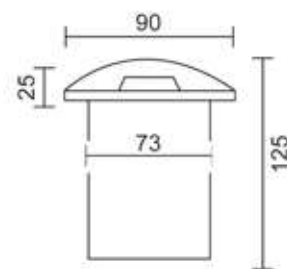

Part No.	Description	Colour	Lamp Holder	Max. Watt	Faceplate	Carton QTY
IGM1SS	INGROUND / WALL 1 WAY MR16 12V SS316 RND	316 SS	1xMR16	20W	Ø90mm	1/20
IGM2SS	INGROUND / WALL 2 WAY MR16 12V SS316 RND	316 SS	1xMR16	20W	Ø90mm	1/20
IGM3SS	INGROUND / WALL 3 WAY MR16 12V SS316 RND	316 SS	1xMR16	20W	Ø90mm	1/20
IGM4SS	INGROUND / WALL 4 WAY MR16 12V SS316 RND	316 SS	1xMR16	20W	Ø90mm	1/20

*To avoid disappointment and warranty problems, please ensure the IP Rating of the chosen product is relevant for the intended use.

MR16 Inground Up Lights (Small Faceplate) Exterior Lighting

- Exterior recessed inground up lights
- Input voltage range: 12–25V AC/DC
- External Control Gear Required
- Housing: 316 Stainless steel/ solid copper
- Faceplate: 316 Stainless steel/ solid copper
- Lamp holder: MR16 (Max.20W)
- Globe not included
- Plastic sleeve included (must be used when installing in concrete)
- Fitting slides into sleeve and remains unattached
- Cable included (L950mm)
- For bollard lights, to maintain the IP rating please use circular cable in junction
- For bollard lights, for parallel and single connection we recommend using an appropriate IP68 connector (CLA Connector: CONN001 & CONN002)



IGMEYEC



IGMEYESS



IGSMC



IGMSMSS

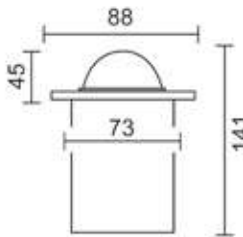

IGMEYE

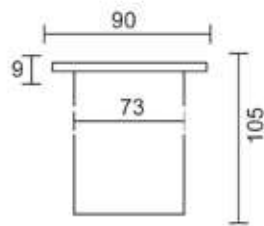

IGMSM & IGMGRSS



IGMGRSS

IGMEYEC	4mm Tempered Glass. Max load capacity 100Kg
IGMEYESS	4mm Tempered Glass. Max load capacity 100Kg
IGSMC	4mm Tempered Glass. Max load capacity 600Kg
IGMSMSS	4mm Tempered Glass. Max load capacity 600Kg
IGMGRSS	4mm Tempered Glass. Max load capacity 600Kg

Part No.	Description	Colour	Lamp Holder	Max. Watt	Faceplate	Carton QTY
IGMEYEC	INGROUND / WALL EYELID MR16 12V COP RND	Polished Copper	1xMR16	20W	Ø88mm	1/20
IGMEYESS	INGROUND / WALL EYELID MR16 12V 316 SS RND	316 SS	1xMR16	20W	Ø88mm	1/20
IGSMC	INGROUND / WALL MR16 12V COP SM RND	Polished Copper	1xMR16	20W	Ø90mm	1/20
IGMSMSS	INGROUND / WALL MR16 12V 316 SS SM RND	316 SS	1xMR16	20W	Ø90mm	1/20
IGMGRSS	INGROUND / WALL Grilled MR16 12V SS316 RND	316 SS	1xMR16	20W	Ø90mm	1/20

**To avoid disappointment and warranty problems, please ensure the IP Rating of the chosen product is relevant for the intended use.*



- Input voltage range: 220–240V 50/60Hz
- Inbuilt constant current LED driver included
- Housing: powder coated aluminium
- Heatsink: aluminium
- Diffuser: glass
- LED chips: SMD2835
- CRI: ≥80
- Power factor: ≥0.9
- Ambient temperature: -20 to 40°C
- Flex & Plug: 1.2m
- App: control all functions via Tuya app on smart devices
- Manual: on/off control via normal wall switch
- Dimmable only via app or voice control through Amazon Alexa, Google Home and other compatible voice activated control devices (Not compatible with wall switch dimmer)
- Setup requires WiFi with Internet connection
- Suitable for 2-way switching
- Not suitable for use with sensor

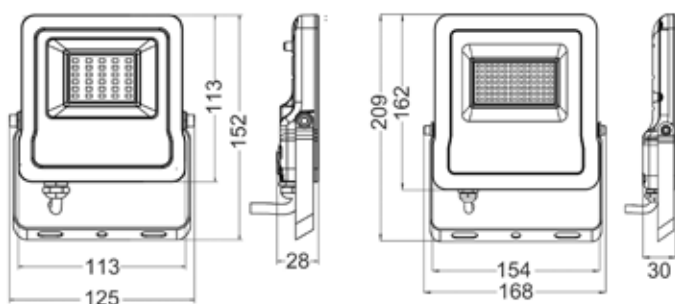

SMTFLOOD1

SMTFLOOD2



Additional SMART Features:

- Tuneable RGB colour spectrum (up to 14 million colours)
- Colour temperature: 5000K
- Works with any 2.4GHz enabled WiFi network (note: will not currently pair with 5.0GHz bandwidth.) or Bluetooth LE 4.2
- Create schedules plans, Biorhythm and timing to automate your home
- Ability to set power-on behaviour
- Control from anywhere via app or voice control using Alexa Hubs, Google Home and other compatible devices
- Compatible with all Tuya Powered apps



Part No.	Description	Kelvin	Lumens	Watt	Product Dimensions	Carton QTY
SMTFLOOD1	FLOOD LED SMART Blk Dimm 5K+RGB 10W	5000K	800LM	10W	152x125x28mm	1/20
SMTFLOOD2	FLOOD LED SMART Blk Dimm 5K+RGB 30W	5000K	2400LM	30W	209x168x30mm	1/20

*To avoid disappointment and warranty problems, please ensure the IP Rating of the chosen product is relevant for the intended use.

TABLET Exterior Lighting

- LED slim flood light
- Input voltage range: 220-240V AC 50/60Hz
- Constant voltage driver included
- Housing & heatsink: aluminium
- Diffuser: clear shatter proof glass
- Mounting bracket: iron
- LED type: 35pcs SMD2835
- Power factor: >0.9
- CRI: 80
- Flex & plug: 1200mm
- Adjustable: 180°
- Ambient temperature: -20 to 40°C
- Not suitable for dimming
- Suitable for 2-way switching
- Suitable for use with PIR or Microwave sensors



TABLET2B

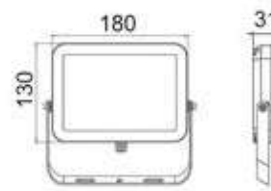

Part No.	Description	Kelvin	Lumens	Watt	CRI	Beam Angle	Carton QTY
TABLET2B	FLOOD LED MATTE BLK SLIM 5000K 30W	5000K	2400lm	30W	80	110°	1/16

FLOOD

- LED slim flood lights
- Input voltage: 240V 50/60Hz
- Housing: PC
- Bracket: aluminium
- LED chips: SMD 2835
- Power factor: ≥0.9
- Flex & plug not included
- Ambient temperature: -20 to 40°C
- Not suitable for dimming
- Suitable for 2-way switching
- Suitable for use with Microwave or PIR sensors

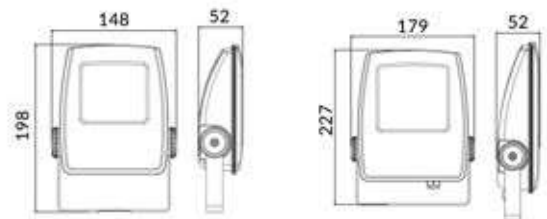

FLOOD15

FLOOD16



Part No.	Description	Kelvin	Lumens	Watt	CRI	Dimensions	Carton QTY
FLOOD15	FLOOD LED BLK P/C (aluminum bracket) 15W	5000K	1200LM	15W	80	148x198x52mm	1/10
FLOOD16	FLOOD LED BLK P/C (aluminum bracket) 30W	5000K	2200LM	30W	80	179x227x52mm	1/10

*To avoid disappointment and warranty problems, please ensure the IP Rating of the chosen product is relevant for the intended use.

- LED high wattage slim flood light
- Input voltage range: 100-240V AC 50/60Hz
- Meanwell constant current driver included
- Housing: powder coated aluminium
- Diffuser: PC
- LED chips: 150pcs SMD3030 LED
- Wattage: 150W (=350W MH)
- Power factor: ≥ 0.9
- Flex & 2 pin plug: 1500mm
- Ambient temperature: -20 to 50°C
- Not suitable for dimming
- Suitable for 2-way switching



Angled / offset bracket for easy installation

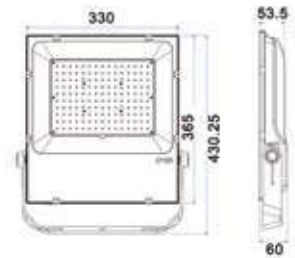

Part No.	Description	Kelvin	Lumens	Watt	CRI	Power Factor	Dimensions	Carton QTY
FLOOD22	FLOOD LED BLK 5000K 150W IP65	5000K	18000LM	150W	70	≥ 0.9	330x365x60mm	1/1

- LED high wattage slim flood light
- Input voltage range: 100-277V AC 50/60Hz
- Diffuser: PC
- LED chips: 224pcs SMD3030 LED
- Power factor: 0.95
- Flex & 3 pin plug: 1200mm
- Ambient temperature: -20 to 50°C
- Not suitable for dimming
- IPART & VEU approved

IPART & VEU APPROVED



Angled / offset bracket for easy installation

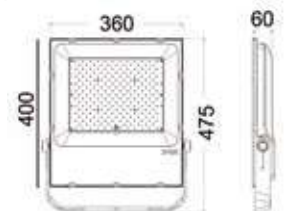

Part No.	Description	Kelvin	Lumens	Watt	CRI	Power Factor	Dimensions	Carton QTY
FLOOD14	FLOOD LED BLK 200W SMD	5000K	25000LM	200W	70	0.95	360x475x60mm	1/1

*To avoid disappointment and warranty problems, please ensure the IP Rating of the chosen product is relevant for the intended use.



- Exterior LED waterproof **DUAL POWER TRI-CCT** battens
- Input voltage range: 220-240V 50Hz
- Inbuilt Constant Current LED driver
- Housing & diffuser: PC
- Tri-CCT (3000K/ 4000K/ 5000K) in one fitting
- Tri-CCT switch on internal driver
- Wattage switch inside driver
- LED chips: 120pcs or 240pcs SMD2835
- CRI: >80
- Power factor: 0.9
- Ambient temperature: -20 to 40°C
- Suitable for 2-way switching
- Suitable for use with 3 wire motion or Microwave sensors
- Includes: 2xMounting brackets(SS grade 304);
1xConnector(IP65)



SHIELDTRI1
SHIELDTRI2



Back plate



SHIELDTRI1

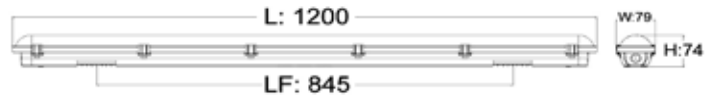

SHIELDTRI2

Part No.	Description	Lumens				Dimensions	Carton QTY
		3000K		4000K			
SHIELDTRI1	BATTEN LED S/M TRIP-ROOF 9W/18W	9W	18W	9W	18W	600x80x75 mm	1/10
		800LM	1600LM	1000LM	2000LM		
SHIELDTRI2	BATTEN LED S/M TRIP-ROOF 18W/36W	18W	36W	18W	36W	1200x80x75 mm	1/10
		1750LM	3500LM	2000LM	4000LM		



*To avoid disappointment and warranty problems, please ensure the IP Rating of the chosen product is relevant for the intended use.



**GENERAL LIGHTING
DOWNLIGHTS**

- LED SMART dimmable Tri-CCT + RGB downlight
- Input voltage range: 220-240V 50Hz
- Inbuilt constant current LED driver included
- Housing: plastic & aluminium
- Faceplate: PC
- Heatsink: aluminium
- Frosted Diffuser
- LED chips: SMD2835
- CRI: ≥80
- Power factor: ≥0.5
- Ambient temperature: -20 to 40°C
- Flex & Plug: 1m
- **App: control all functions via Tuya app on smart devices**
- **Manual: on/off control via normal wall switch**
- **Dimmable only via app or voice control through Amazon Alexa, Google Home and other compatible voice activated control devices (Not compatible with wall switch dimmer)**
- Setup requires WiFi with Internet connection
- Suitable for 2-way switching
- Not suitable for use with sensor



SMTNOVA1

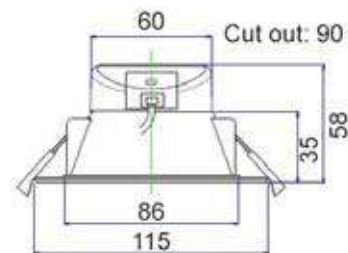
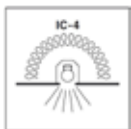
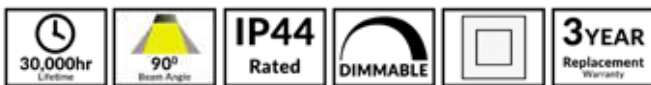

Additional SMART Features:

- Tuneable RGB colour spectrum (up to 14 million colours)
- Tuneable colour temperature (3000K warm white through to 6500K daylight)
- Works with any 2.4GHz enabled WiFi network (note: will not currently pair with 5.0GHz bandwidth or Bluetooth LE 4.2)
- Create schedules and timing to automate your home
- Control from anywhere via app or voice control using Alexa Hubs, Google Home and other compatible devices
- Compatible with all Tuya Powered apps



Scan QRCode to download



Part No.	Description	Kelvin	Lumens	Watt	Product Dimensions	Cut Out	Carton QTY
SMTNOVA1	D/L LED SMART WH RND DIMM TRI+RGB	RGB+ 3000- 6500K	750LM - 3000K 820LM - 6500K 60LM - Red 45LM - Blue 190LM - Green	9W	Ø115x58mm	Ø90mm	1/48

NOVACOB Downlights - Recessed LED



- LED dimmable Tri-CCT with magnetic changeable faceplate downlights
- Input voltage range: 220-240V 50/60Hz
- Inbuilt constant current driver included
- Housing: aluminium & plastic
- Faceplate: powder coated aluminium
- Diffuser: PC
- Tri-CCT (3000K/ 4000K/ 5700K) in one fitting
- CCT switch on rear
- LED chip: 1PC COB SMD2835
- Power factor: 0.9
- CRI: ≥ 80
- Flex & plug: 0.6m
- Ambient temperature: -20 to 40°C
- Suitable for dimming
- Suitable for 2-way switching
- Suitable for use with sensors

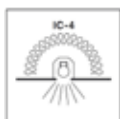

Tested & Recommended Dimmers:

Brand	Part No.
CLIPSAL	32E450TM
HPM	CAT400T
DIGINET	MEDM, MMDM/RT



Box Include:

- 1x Downlight (NOVACOB)
- 1x Loose Satin Chrome (NOVADSC) faceplate
- 1x Loose White faceplate



NOVACOB01



NOVADSC

Available faceplates (Sold Separately):

- Matte Black (NOVADBLK)
- Antique Brass (NOVADBR)



NOVADBR

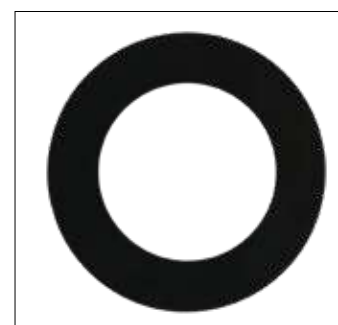

NOVADBLK

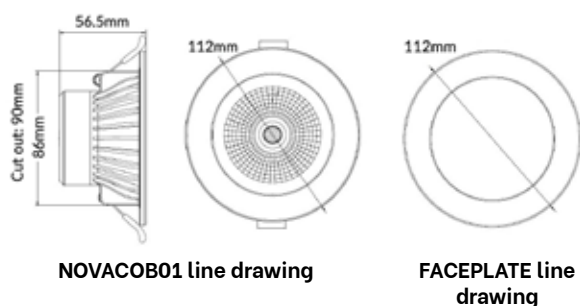

Part No.	Description	Lumens			Watt	Cut Out	Carton QTY
		3000K	4000K	5700K			
NOVACOB01	D/L LED COB FIXED WH+S/C DIMM RND TRI	800LM	950LM	850LM	10W	Ø90mm	1/40
NOVADBLK	FACEPLATE TO SUIT NOVACOB01 MATTE BLK OD 112mm						
NOVADBR	FACEPLATE TO SUIT NOVACOB01 ANTIQUE BRASS OD 112mm						



- LED dimmable Tri-CCT with changeable faceplate (via clip) recessed downlights
- Input voltage range: 220-240V 50/60Hz
- Inbuilt constant current driver included
- Housing: aluminium & plastic
- Faceplate: powder coated aluminium
- Diffuser: frosted PC
- Tri-CCT (3000K/ 4000K/ 5700K) in one fitting
- CCT switch on side
- LED chip: 24pcs SMD2835
- Power factor: 0.9
- CRI: ≥80
- Flex & plug: 600mm
- Ambient temperature: -20 to 40°C
- Suitable for dimming
- Suitable for 2-way switching
- Suitable for use with sensors

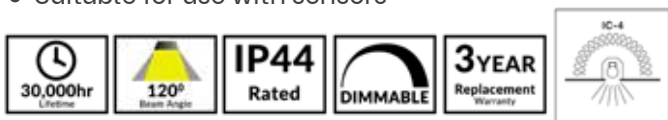

Tested & Recommended Dimmers:

Brand	Part No.
CLA	VELA
CLIPSAL	32E450TM
HPM	CAT400T
DIGINET	MEDM, MMDM/RT

NOVADLUX01A Box Include:

- 1x Downlight (NOVADLUX01A) with white faceplate
- 1x Loose Satin Chrome faceplate



NOVADLUX01A



Satin Chrome Faceplate

Available faceplates (Sold Separately):

- Matte Black (NOVADBLK01A)
- Antique Brass (NOVADBR01A)



NOVADBR01A

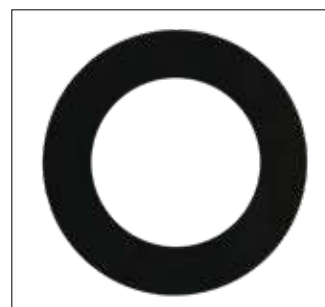

NOVADBLK01A

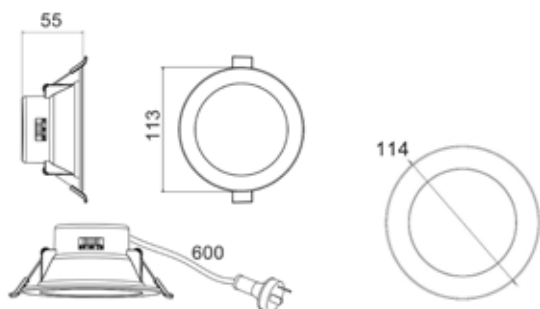

NOVADLUX01A Line Drawing

Faceplate Line Drawing

Part No.	Description	Lumens			Watt	Dimensions	Cut Out	Carton QTY
		3000K	4000K	5700K				
NOVADLUX01A	D/L LED COB FIXED WH+S/C DIMM RND TRI	800LM	950LM	850LM	10W	Ø113x55mm	Ø90mm	1/40
NOVADBLK01A	FACEPLATE TO SUIT NOVADLUX01A MATTE BLK Ø113mm							
NOVADBR01A	FACEPLATE TO SUIT NOVADLUX01A ANTIQUE BRASS Ø113mm							

- LED dimmable Tri-CCT with changeable faceplate (via clip) recessed downlights
- Input voltage range: 220-240V 50/60Hz
- Inbuilt constant current driver included
- Housing: aluminium & plastic
- Faceplate: White: plastic
- Faceplate: Satin chrome, matte black & brass: aluminium
- Diffuser: frosted PC
- Tri-CCT (3000K/ 4000K/ 5700K) in one fitting
- CCT switch on side
- LED chip: 20pcs SMD2835
- Power factor: 0.9
- CRI: ≥80
- Flex & plug: 600mm
- Ambient temperature: -20 to 40°C
- Suitable for dimming
- Suitable for 2-way switching
- Suitable for use with sensors



NOVADLUX02 Box Include:

- 1x Downlight (NOVADLUX02) with white faceplate
- 1x Loose Satin Chrome (NOVADSC02) faceplate



NOVADLUX02



NOVADSC02

Tested & Recommended Dimmers:

Brand	Part No.
CLIPSAL	32E450TM
HPM	CAT400T
DIGINET	MEDM, MMDM/RT

Available faceplates (Sold Separately):

- Matte Black (NOVADBLK02)
- Antique Brass (NOVADBR02)

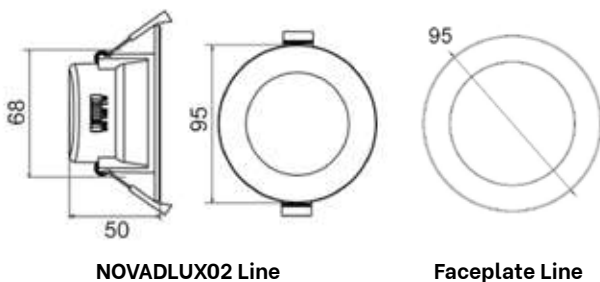

NOVADLUX02 Line

Faceplate Line



NOVADBR02



NOVADBLK02

Part No.	Description	Lumens			Watt	Dimensions	Cut Out	Carton QTY
		3000K	4000K	5700K				
NOVADLUX02	D/L LED FIXED WH+S/C DIMM RND TRI	640LM	720LM	680LM	8W	Ø95x50mm	Ø70mm	1/50
NOVADBLK02	FACEPLATE TO SUIT NOVADLUX02 MATTE BLK OD 95mm							
NOVADBR02	FACEPLATE TO SUIT NOVADLUX02 ANTIQUE BRASS OD 95mm							

FIREFLY Downlights - Recessed LED



- LED gimbal white dimmable Tri-CCT recessed downlights
- Input voltage: 220-240V
- External Constant Current LED driver included
- Degree of tilt: 20°
- Housing & heatsink: plastic & aluminium
- Diffuser: clear PC
- Faceplate: plastic
- LED chip: 1pc COB
- Colour temperature changeable: 3000K/ 4000K/ 5700K
- Rear switch
- CRI: >80
- Power factor: >0.9
- Flex & plug: 0.6m
- Ambient temperature: -20 to 40°C
- Suitable for dimming
- Suitable for 2-way switching
- Suitable for use with PIR & Microwave sensors

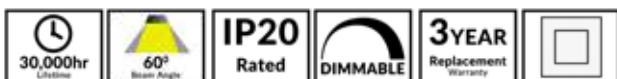

Tested & recommended dimmers:

BRAND	PART NO.
CLA	VELA
CLIPSAL	32E450TM, 32ELEDM
HPM	CAT400T
DIGINET	MEDM, MMDM/RT



FIREFLY01A



CENTRE TILT: 20°



REAR CCT SWITCH

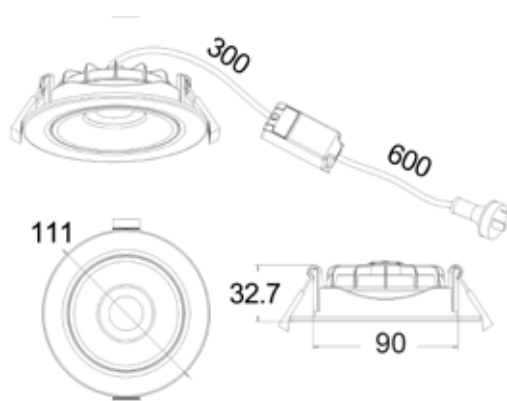

PART NO.	DESCRIPTION	LUMENS			WATT	DIMENSIONS	CUT OUT	CARTON QTY
		3000K	4000K	5700K				
FIREFLY01A	D/L LED GIMBAL DIMM WH RND Tri	640LM	720LM	720LM	8W	Ø111X32.7mm	Ø90mm	1/40

COMET Downlights - Recessed LED



- LED recessed Tri-CCT dimmable centre tilt downlights
- Input voltage range: 185-265V AC 50/60Hz
- Constant current LED driver included
- Material: aluminium body & PMMA lens
- Heatsink: aluminium
- Centre tilt: 25°
- Tri-CCT (3000K/ 4200K/ 6000K) in one fitting
- LED chips: 1pc COB LED
- Power factor: ≥0.9
- Ambient temperature: -20 to 40°C
- Flex & plug: COMET01&03: 1640mm;
COMET02&04: 1460mm
- Suitable for 2-way switching
- Suitable for dimming
- Suitable for 3 wire motion/ microwave sensors

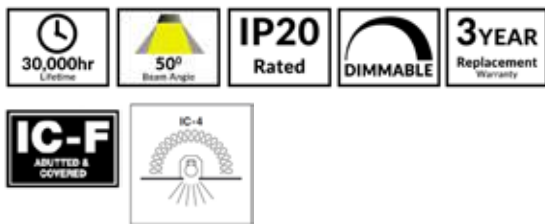

COMET01

COMET03



COMET02

COMET04

TRI-CCT switch on rear



Tested & Recommended Dimmers:

Brand	Part No.
Diginet	MEDM & MMDM/RT
CLIPSAL	32ELEDM-WE, 32E450TM, 32E450LM, 32E450UDM & 31E2PUDM
HPM	CAT250L, CAT250T & CAT400T

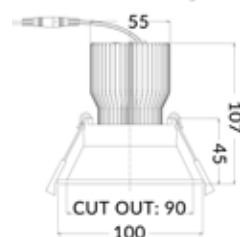

COMET01 & 03

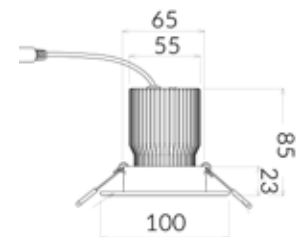

COMET02 & 04

Part No.	Description	Lumens			Watt	CRI	Diam	Depth	Cut Out	Carton QTY
		3000K	4200K	6000K						
COMET01	D/L LED DIMM C/TILT MATTE BL RND LOW GLARE Tri	750LM	850LM	800LM	10W	80	Ø100mm	107mm	Ø90mm	1/24
COMET02	D/L LED DIMM C/TILT MATTE Brushed Nickel Tri	800LM	900LM	850LM	10W	80	Ø100mm	85mm	Ø70-90mm	1/24
COMET03	D/L LED DIMM C/TILT MATTE WH RND LOW GLARE Tri	750LM	850LM	800LM	10W	80	Ø100mm	107mm	Ø90mm	1/24
COMET04	D/L LED DIMM C/TILT WH RND Tri	800LM	900LM	850LM	10W	80	Ø100mm	85mm	Ø70-90mm	1/24

- LED dimmable low glare Tri-CCT downlights
- Input voltage: 220-240V AC
- Inbuilt constant current LED driver included
- Housing & heatsink: plastic & aluminium
- Diffuser: PC
- Tri-CCT (3000K/ 4000K/ 6000K) in one fitting
- Rear switch
- CRI: ≥ 80
- Power factor: 0.9
- Flex & plug: 1m
- Ambient temperature: -20 to 40°C
- Suitable for dimming
- Suitable for 2-way switching
- COMET05-06: IP20 (IP54 for front face only)
- COMET07-08: IP20

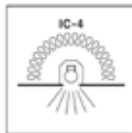

COMET05-06



COMET07-08



COMET05



COMET06

Tested & Recommended Dimmers:

Brand	Part No.
CLA	VELA
CLIPSAL	32E450UDM, 31E2PUDM, 32ELEDM-WE, 32E450TM
HPM	CAT250T, CAT400T
DIGINET	MEDM



COMET07 (GIMBAL)



COMET07-8 Tilt: 30° COMET08 (GIMBAL)



Part No.	Description	Lumens			Watt	Dimensions	Cut Out	Carton QTY
		3000K	4000K	6000K				
COMET05	D/L LED FIXED DIMM BLK RND Low Glare COB TRI	700LM	800LM	750LM	9W	Ø100x85mm	Ø85-90mm	1/45
COMET06	D/L LED FIXED DIMM WH RND Low Glare COB TRI	700LM	800LM	750LM	9W	Ø100x85mm	Ø85-90mm	1/45
COMET07	D/L LED GIMBAL DIMM BLK RND Low Glare COB TRI	700LM	800LM	750LM	9W	Ø105x85mm	Ø90mm	1/45
COMET08	D/L LED GIMBAL DIMM WH RND Low Glare COB TRI	700LM	800LM	750LM	9W	Ø105x85mm	Ø90mm	1/45

GALTRI Downlights - Recessed LED



- LED dimmable Tri-CCT recessed downlights
- Input voltage: 220-240V
- Remote dimmable driver included
- Housing & heatsink: plastic & aluminium
- Diffuser: frosted PC
- Faceplate: PBT
- LED chip: SMD2835
- Tri-CCT (3000K/ 4000K/ 5700K) in one fitting
- GALTRI01A-02A: CCT switch on driver
- GALTRI04-05: rear switch
- CRI: ≥ 80
- Power factor: >0.9
- Flex & plug: 600mm
- Ambient temperature: -20 to 40°C
- Suitable for dimming
- Suitable for 2-way switching
- Suitable for use with sensors

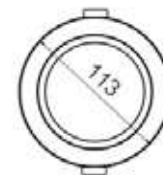
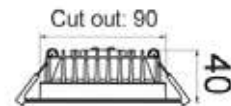
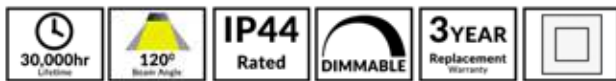

GALTRI01A-02A

Tested & Recommended Dimmers:

Brand	Part No.
CLA	VELA
CLIPSAL	32E450TM, 32ELEDM
HPM	CAT400T
DIGINET	MEDM, MMDM/RT

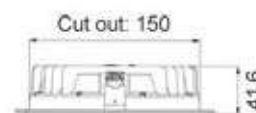

GALTRI04

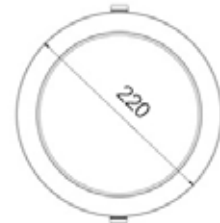

GALTRI05

Part No.	Lumens			Watt	CRI	Power Factor	Dimensions	Cut out	Carton QTY
	3000K	4000K	5700K						
GALTRI01A	750LM	850LM	750LM	10W	≥ 80	0.9	$\varnothing 113 \times 40\text{mm}$	$\varnothing 90\text{mm}$	1/40
GALTRI02A	900LM	1020LM	900LM	12W	≥ 80	0.9	$\varnothing 113 \times 40\text{mm}$	$\varnothing 90\text{mm}$	1/40
GALTRI04	1700LM	2000LM	1800LM	20W	≥ 80	0.9	$\varnothing 174 \times 41.6\text{mm}$	$\varnothing 150\text{mm}$	1/24
GALTRI05	2250LM	2600LM	2350LM	25W	≥ 80	0.9	$\varnothing 220 \times 41.7\text{mm}$	$\varnothing 200\text{mm}$	1/16



- Input voltage: 220-240V AC 50/60Hz
- External constant current LED driver included
- Housing & heatsink: plastic & aluminium
- Diffuser: Opal PC
- Faceplate: PBT
- Power factor: 0.9
- Tri-CCT (3000K/ 4000K/ 5700K) in one fitting
- CCT switch on driver
- LED chips: SMD2835
- CRI: ≥ 80
- Flex & plug: 600mm
- Ambient temperature: -20 to 40°C
- Suitable for dimming
- Suitable for 2-way switching
- Suitable for use with sensor



Tested & Recommended Dimmers:

BRAND	PART NO.
CLA	VELA
CLIPSAL	32E450UDM, 31E2PUDM, 32ELEDM-WE, 32E450TM,
HPM	CAT250T, CAT400T
DIGINET	MEDM, MMDM/RT

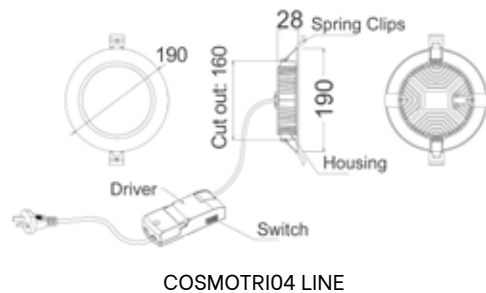
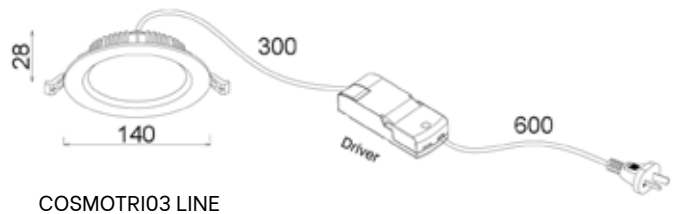

Part No.	Lumens			Watt	CRI	Power Factor	Dimensions	Cut out	Carton QTY
	3000K	4000K	5700K						
COSMOTRI03	1200LM	1350LM	1250LM	15W	≥ 80	0.9	$\varnothing 140 \times 28 \text{mm}$	$\varnothing 120 \text{mm}$	1/30
COSMOTRI04	1800LM	2000LM	1900LM	20W	≥ 80	0.9	$\varnothing 190 \times 28 \text{mm}$	$\varnothing 160 \text{mm}$	1/20



PIR Sensor

- LED Tri-CCT motion sensor downlight
- Input voltage: 220-240V 50Hz
- Inbuilt constant current driver included
- Housing & heatsink: plastic & aluminium
- LED chips: SMD2835
- Colour temperature changeable: 3000K/ 4000K/ 5000K
- Rear switch
- Power factor: 0.9
- CRI: ≥ 80
- Flex & plug: 1.0m
- Ambient temperature: -20 to 40°C
- Not suitable for dimming
- Suitable for 2-way switching

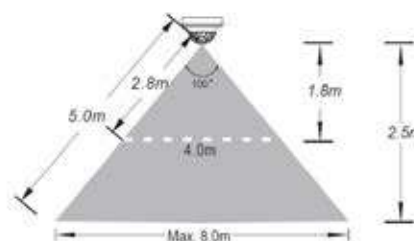

Recommended Height of Installation: 1.8-2.5m

Detection Distance: Max. 8m

Height: 1.8M = 4 meter detection range

Height: 2.5M = 8 meter detection range

***Note: The detection distance will vary with change of installation height**

Sensor Technical Spec:

- Sensor type: PIR
- Wattage / power consumption: $< 0.5\text{W}$
- Installation height: 1.8-2.5m
- Detection angle: 360°
- Motion detection speed: 1.5m/s
- Time delay: $70 \pm 10\text{s}$
- UV resistant: Yes
- Manual override: No

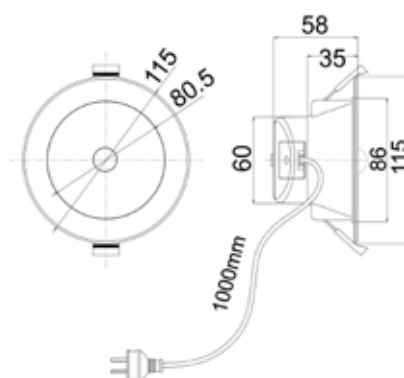

Part No.	Description	Lumens			Watt	CRI	Dimensions	Cut out	Carton QTY
		3000K	4000K	5000K					
NOVATRIS	D/L LED FIXED DIMM MOTION SENSOR WH RND TRI	750LM	850LM	800LM	9W	80	$\varnothing 115 \times 58\text{mm}$	$\varnothing 90\text{mm}$	1/48

MOTION Downlights - Recessed LED

- LED recessed motion sensor downlights
- Input voltage range: 180-260V AC 50/60Hz
- Constant current LED driver included
- Material: aluminium & PC
- LED chips: SMD2835 LED
- Power factor: >0.5
- CRI: >80

Sensor Technical Spec:

- Sensor type: PIR
- Max. detection diameter radius: 5m
- Sensor time delay: 90 seconds
- Detection range: 80°
- Block time: 0.2 seconds
- Flex & plug: 1200mm
- Ambient temperature: -20 to 45°C
- Not suitable for dimming
- Suitable for 2-way switching
- Sensor operates Day and Night (No Manual Override)



PIR Sensor

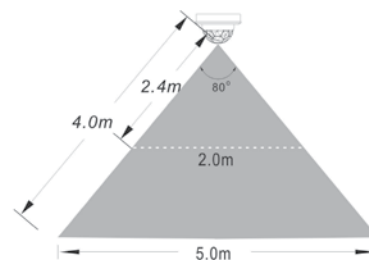

Applications:

Great design. Suitable for hallway, laundry room, living room and most indoor locations.

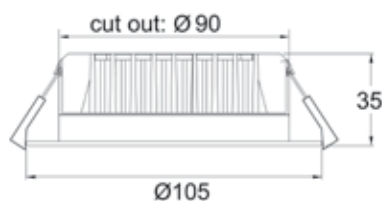

MOTION1 & 3



MOTION2 & 4

Part No.	Kelvin	Lumens	LED Chips	Watt	CRI	Diam	Depth	Cut Out	Carton QTY
MOTION1	3000K	800LM	24pcs 2835	10W	>80	Ø105mm	35mm	Ø90mm	1/36
MOTION2	3000K	1200LM	36pcs 2835	15W	>80	Ø145mm	46mm	Ø120mm	1/24
MOTION3	5000K	850LM	24pcs 2835	10W	>80	Ø105mm	35mm	Ø90mm	1/36
MOTION4	5000K	1250LM	36pcs 2835	15W	>80	Ø145mm	46mm	Ø120mm	1/24



- LED dimmable ultra slim Tri-CCT recessed downlights
- Input voltage range: 220-240V
- Remote constant current driver included
- Housing & faceplate: PC
- Diffuser: white PS
- Tri-CCT (3000K/ 4000K/ 5000K) in one fitting
- CCT switch on DC cable
- LED chips: SMD2835
- Power factor: 0.9
- CRI: >80
- Flex & plug: 1.2m
- Ambient temperature: -20 to 40°C
- Suitable for dimming
- Suitable for 2-way switching
- Suitable for use with Microwave/ motion sensor
- Recommended usage: 8-10 hours/day
- The driver should NOT BE covered with thermal insulation



Tested & Recommended Dimmers:

Brand	Part No.
CLA	VELA
CLIPSAL	32E450UDM, 31E2PUDM, 32ELEDDWE, 32E450TM, PDL354PBDMUN-VW
HPM	Cat 250T, Cat 400T
DIGINET	MEDM, MMDM/RT

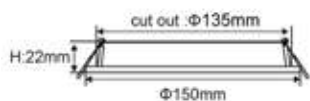

SLICKTRI1R

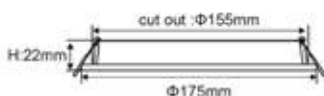

SLICKTRI2R



SLICKTRI3R

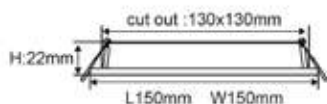

SLICKTRI1S

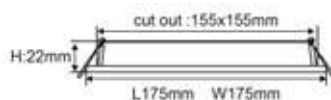

SLICKTRI2S

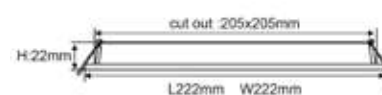

SLICKTRI3S

Part No.	Shape	Lumens			Watt	Dimensions	Driver Size	Switch Size	Carton QTY
		3000K	4000K	5000K					
SLICKTRI1R	Round	630LM	720LM	680LM	9W	Ø150x22mm	80x31x20mm	45x23x15mm	1/40
SLICKTRI2R	Round	840LM	960LM	900LM	12W	Ø175x22mm	87x37x20mm	45x23x15mm	1/40
SLICKTRI3R	Round	1350LM	1550LM	1450LM	18W	Ø222x22mm	87x37x20mm	45x23x15mm	1/20
SLICKTRI1S	Square	630LM	720LM	680LM	9W	150x150x22mm	80x31x20mm	45x23x15mm	1/40
SLICKTRI2S	Square	840LM	960LM	900LM	12W	175x175x22mm	87x37x20mm	45x23x15mm	1/40
SLICKTRI3S	Square	1350LM	1550LM	1450LM	18W	222x222x22mm	87x37x20mm	45x23x15mm	1/20



SHOPTRI01



Power switch & CCT switch on rear

- LED gimabl white recessed shop lighter downlight
- 6 fittings in 1: Dual power & Tri-CCT changeable
- Input voltage: 220-240V AC 50/60Hz
- Remote Constant Current driver included
- Degree of tilt: 500
- Housing & heatsink: aluminium
- Diffuser: Textured clear glass
- Faceplate: powder coated aluminium
- Dual power: 28W/ 38W
- Tri-CCT (3000K/ 4000K/ 5700K) in one fitting
- Rear switches
- Power factor: 0.94
- LED chips: SMD2835
- CRI: ≥80
- Flex & plug: 1500mm
- Ambient temperature: -20 to 40°C
- Not suitable for dimming
- Suitable for use with PIR/ Microwave sensors

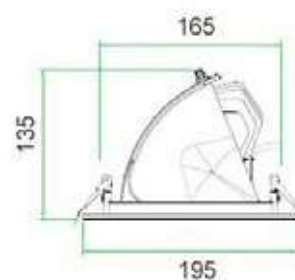

30,000hr
Lifetime

90°
Beam Angle

IP20
Rated

3YEAR
Replacement
Warranty

GENERAL LIGHTING

Part No.	Description	Lumens						Dimensions	Cut Out	Carton QTY
		3000K		4000K		5700K				
		28W	38W	28W	38W	28W	38W			
SHOPTRI01	D/L LED SHOP GIMBAL WH RND 28W/38W	2426LM	3270LM	2800LM	3800LM	2460LM	3300LM	Ø195X- 135mm	Ø165mm	1/12

- LED gimbal dimmable Tri-CCT rectangular shop lighter
- Input voltage: 200-240V AC 50/60Hz
- External constant current dimmable driver included
- Housing: white powder coated aluminium
- Textured clear glass diffuser
- Mounting plate & heatsink: aluminium
- Surface mounted or recessed
- Adjustable: 90°
- Tri-CCT (3000K / 4000K / 5700K) switch on DC cable
- LED chips: SMD2835
- Power factor: 0.95
- CRI: ≥80
- Flex & plug: 1200mm
- Ambient temperature: -20 to 40°C
- Mounting bracket: L 222mm x W 28.2mm
- Suitable for dimming
- Suitable for 2 way switching
- Suitable for use with PIR/ Microwave sensors



SHOPTRI



Tested & Recommended Dimmers:

Brand	Part No.
CLIPSAL	32ELEDM, 32E45UDM, 31E2PUDM
HPM	CAT250, CAT250T, CAT400T
DIGINET	MMDM/RT, MEDM

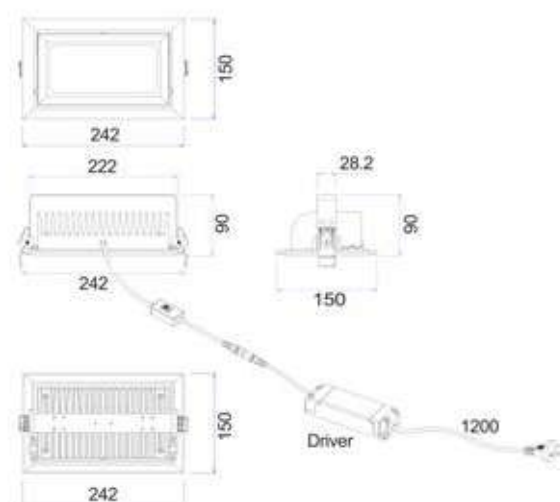

Part No.	Description	Lumens			Watt	Power Factor	Dimensions	Cut Out	Carton QTY
		3000K	4000K	5700K					
SHOPTRI	D/L LED SHOP GIMBAL DIMM WH RECT 35W TRI	2900LM	3200LM	3000LM	35W	0.95	242x150x-90mm	230x130mm	1/6

SURFACE (GU10) Downlights - Surface Mounted



SURFACE17A



SURFACE18A



SURFACE22



SURFACE23



SURFACE24



SURFACE25

- GU10 surface mounted downlights
- Input voltage range: 220-240V
- Housing: powder coated aluminium
- Mounting plate: aluminium
- Fitting colours: matte black and matte white
- SURFACE22-25: 15°C tilt/ adjustable
- Lamp holder: GU10 (Max.50W)
- Globe not included
- Flex & plug not included

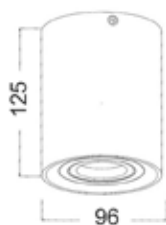

SURFACE17A-18A



SURFACE22-23

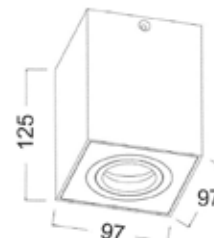

SURFACE24-25

Part No.	Description	Lamp Holder	Max. Wattage	Barrell	Carton QTY
SURFACE17A	D/L GU10 (Max 50W) S/M Matte WH RND	GU10	50W	Ø96x125mm	1/30
SURFACE18A	D/L GU10 (Max 50W) S/M Matte BLK RND	GU10	50W	Ø96x125mm	1/30
SURFACE22	D/L GU10 (Max 50W) S/M Gimbal Matte WH RND	GU10	50W	Ø96x125mm	1/20
SURFACE23	D/L GU10 (Max 50W) S/M Gimbal Matte BLK RND	GU10	50W	Ø96x125mm	1/20
SURFACE24	D/L GU10 (Max 50W) S/M Gimbal Matte WH SQ	GU10	50W	97x97x125mm	1/20
SURFACE25	D/L GU10 (Max 50W) S/M Gimbal Matte BLK SQ	GU10	50W	97x97x125mm	1/20

SURFACE (LED) Downlights - Surface Mounted



SURFACE13-14



- LED surface mounted ceiling downlights
- Input voltage range: 220-240V AC 50/60Hz
- Constant current LED driver included
- Housing & heat sink: aluminium
- Bracket: aluminium
- LED chips: 1pc COB
- Power factor: ≥ 0.9
- CRI: ≥ 80
- Ambient temperature: -20 to 40°C
- 150mm 3 core cable without plug
- Suitable for dimming
- Recommended Universal trailing edge & leading edge dimmers
- Suitable for 2-way switching
- Suitable for use with PIR sensors



Tested & Recommended Dimmers:

Brand	Part No.
HPM	CAT250L, CAT250T, CAT400T
CLIPSAL	32ELEDM, 31E2PUDM, 32E450UDM, 32E450LM

Part No.	Description	Kelvin	Lumens	Watt	CRI	Barrell	Carton QTY
SURFACE13	D/L DIMM LED S/M WHITE GLOSS RND	3000K	800LM	13W	≥ 80	$\varnothing 105 \times 146 \text{mm}$	1/12
SURFACE14	D/L DIMM LED S/M WHITE GLOSS RND	5000K	900LM	13W	≥ 80	$\varnothing 105 \times 146 \text{mm}$	1/12



GENERAL LIGHTING
SPOT LIGHTS

SPOT Spot Lights

- Input voltage: 100-240V AC 50/60Hz
- Housing: powder coated aluminium
- Mounting plate: iron
- 180° Tilt / 328° swivel
- Lamp holder: GU10 (Max.50W)
- Globe not included
- **Globe grabber/ suction cap included**



SPOT-R1B



SPOT-S1B



SPOT-R3B



SPOT-BAR3B



SPOT-BAR2B



SPOT-BAR4B

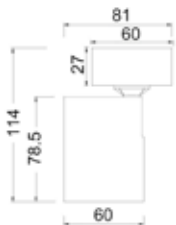

SPOT-R1B

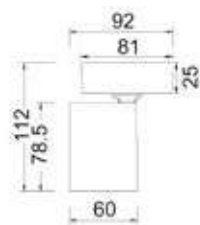

SPOT-S1B

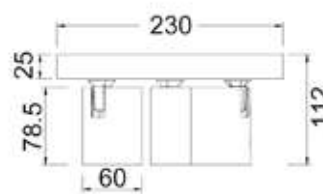

SPOT-R3B

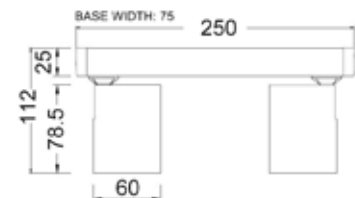

SPOT-BAR2B

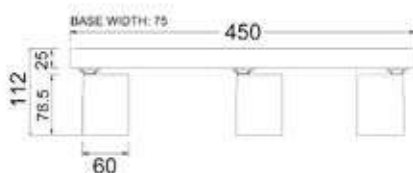

SPOT-BAR3B

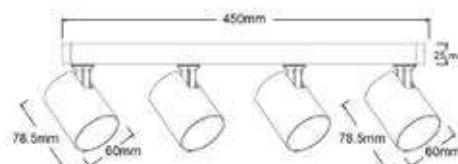

SPOT-BAR4B

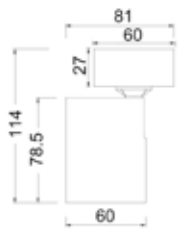

SPOT-R1W

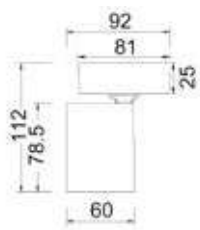

SPOT-S1W

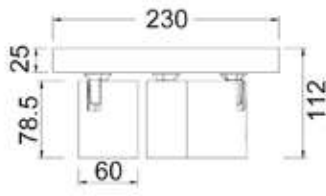

SPOT-R3W



SPOT-R1W



SPOT-S1W

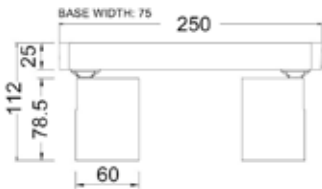

SPOT-BAR2W

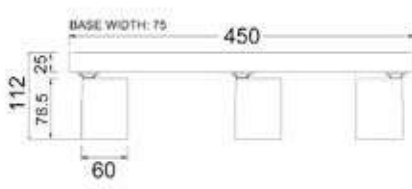

SPOT-BAR3W

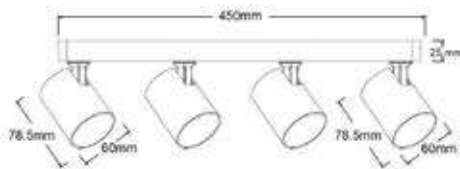

SPOT-BAR4W



SPOT-R3W



SPOT-BAR3W

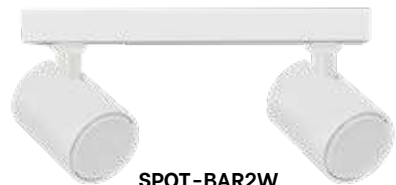

SPOT-BAR2W



SPOT-BAR4W

Part No.	Description	Base	Carton QTY
SPOT-S1B	SPOT GU10 1 LIGHT/ADJ SQ BASE BLK	L81xW81xH25mm	1/50
SPOT-R1B	SPOT GU10 1 LIGHT/ADJ RND BASE BLK	Ø60xH27mm	1/50
SPOT-R3B	SPOT GU10 3 LIGHT/ADJ RND BASE BLK	Ø230xH25mm	1/8
SPOT-BAR2B	SPOT GU10 2 LIGHT/ADJ BAR BLK	L250xW75xH25mm	1/12
SPOT-BAR3B	SPOT GU10 3 LIGHT/ADJ BAR BLK	L450xW75xH25mm	1/8
SPOT-BAR4B	SPOT GU10 4 LIGHT/ADJ BAR BLK	L450xW75xH25mm	1/8
SPOT-S1W	SPOT GU10 1 LIGHT/ADJ SQ BASE WH	L81xW81xH25mm	1/50
SPOT-R1W	SPOT GU10 1 LIGHT/ADJ RND BASE WH	Ø60xH27mm	1/50
SPOT-R3W	SPOT GU10 3 LIGHT/ADJ RND BASE WH	Ø230xH25mm	1/8
SPOT-BAR2W	SPOT GU10 2 LIGHT/ADJ BAR WH	L250xW75xH25mm	1/12
SPOT-BAR3W	SPOT GU10 3 LIGHT/ADJ BAR WH	L450xW75xH25mm	1/8
SPOT-BAR4W	SPOT GU10 4 LIGHT/ADJ BAR WH	L450xW75xH25mm	1/8

TACHE Spot Lights



TACHE1



TACHE2



TACHE3

- Interior spot ceiling lights
- Material: aluminium
- Globe not included
- For indoor use only



Part No.	TACHE1-3
Description	SPOT GU10 Interior Ceiling Lamp Adj Ant/Brs Head w/Brs Rnd Base + Rect BLK Canopy
Material	Aluminium
Lamp holder	TACHE1: 3 x GU10 (Max.35W) TACHE2: 4 x GU10 (Max.35W) TACHE3: 6 x GU10 (Max.35W)
Dimensions	TACHE1: Ø510 x H120mm TACHE2: 520 x 520 x H120mm TACHE3: 720 x 400 x H120mm
Base	TACHE1-2: Ø160 mm TACHE3: Ø180 mm
Canopy	TACHE1: Ø90 x H45mm TACHE2: Ø90 x H45mm TACHE3: Ø100 x H45mm
Carton QTY	1/1

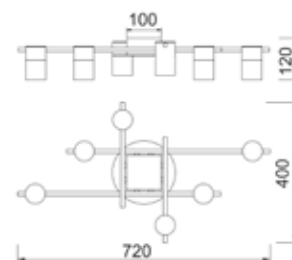
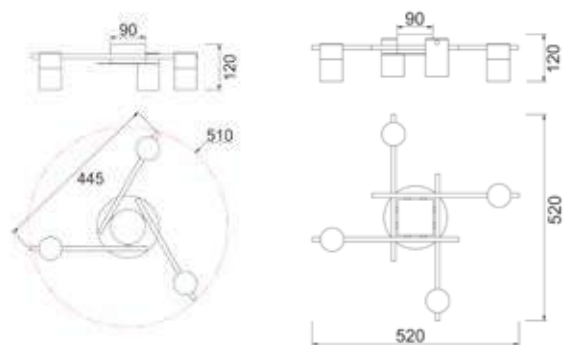



TACHE4



TACHE5



TACHE6

- Interior spot ceiling lights
- Material: aluminium
- Globe not included
- For indoor use only

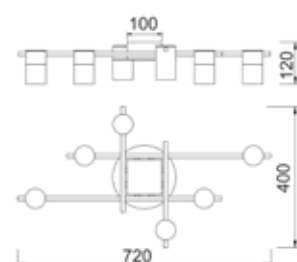
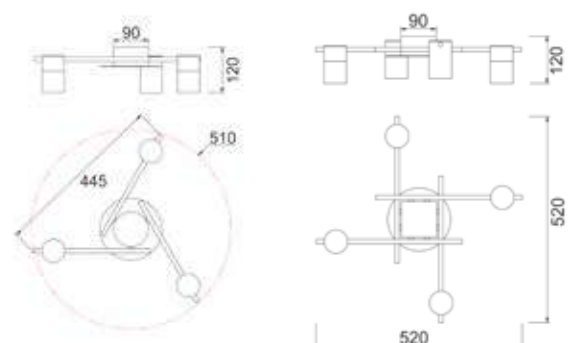

Part No.	TACHE4-6
Description	SPOT GU10 Interior Ceiling Lamp Adj Blk & Ant/Brs Head w/Brs Rnd Base + Rect BLK Canopy
Material	Aluminium
Lamp holder	TACHE4: 3 x GU10 (Max.35W) TACHE5: 4 x GU10 (Max.35W) TACHE6: 6 x GU10 (Max.35W)
Dimensions	TACHE4: Ø510 x H120mm TACHE5: 520 x 520 x H120mm TACHE6: 720 x 400 x H120mm
Base	TACHE4-5: Ø160 mm TACHE6: Ø180 mm
Canopy	TACHE4: Ø90 x H45mm TACHE5: Ø90 x H45mm TACHE6: Ø100 x H45mm
Carton QTY	1/1



GENERAL LIGHTING
OYSTER LIGHTS



- LED smart Tri-CCT dimmable oyster light
- Input voltage range: 220-240V 50Hz
- Inbuilt constant current LED driver included
- Housing: powder coated iron
- Mounting plate: iron
- Heatsink: iron & aluminium
- Diffuser: PMMA
- LED chips: SMD2835
- CRI: ≥ 80
- Power factor: ≥ 0.9
- Ambient temperature: -20 to 40°C
- App: control all functions via Tuya app on smart devices
- Manual: on/off control via normal wall switch
- Dimmable only via app or voice control through Amazon Alexa, Google Home and other compatible voice activated control devices (Not compatible with wall switch dimmer)
- Setup requires WiFi with Internet connection
- Suitable for 2-way switching
- Not suitable for use with sensor

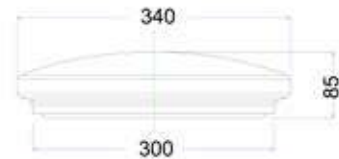
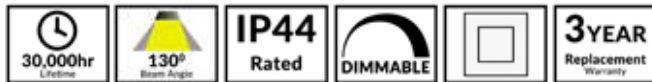

Additional SMART Features:

- Tuneable colour temperature (3000K warm white through to 6500K daylight)
- Works with any 2.4GHz enabled WiFi network (note: will not currently pair with 5.0GHz bandwidth.) or Bluetooth LE 4.2
- Create schedules and timing to automate your home
- Control from anywhere via app or voice control using Alexa Hubs, Google Home and other compatible devices
- Compatible with all Tuya Powered apps

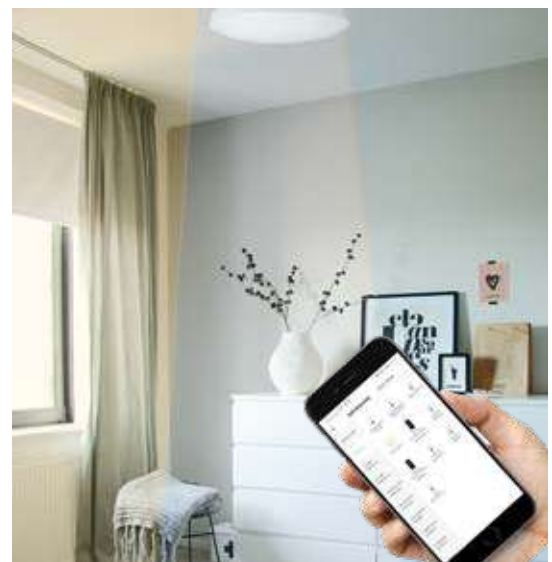

Part No.	Description	Kelvin	Lumens	Watt	Dimensions	Base	Carton QTY
SMTOYS1	OYSTER LED SMART WH RND DIMM TRI CCT	3000-6500K	1350-1550LM	18W	Ø340x85mm	Ø300mm	1/8



- LED Tri-CCT dimmable oyster lights
- Input voltage range: 200-240V AC 50/60Hz
- Inbuilt driver output voltage: 60-80V
- Material: PC
- LED chips: SMD2835
- Power factor: >0.9
- Tri-CCT (3000K/ 4000K/ 5000K) in one fitting
- CRI: 80
- Ambient temperature: -20 to 40°C
- Suitable for dimming
- Suitable for 2-way switching
- Suitable for use with PIR or microwave sensors
- Suitable for indoor & outdoor use
- Changes to appearance due to climatic conditions not covered under warranty

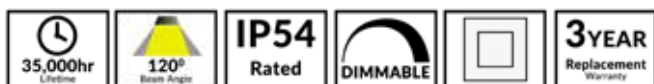

Tested & Recommended Dimmers:

Brand	Part No.
HPM	CAT250L
CLIPSAL	32ELEDM, 31E2PUDM, 32E450T, 31E450UDM

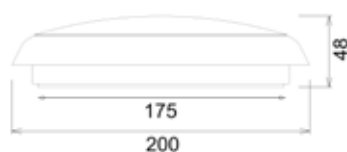

OYSDIM001

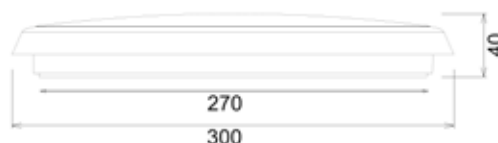

OYSDIM002

Part No.	Lumens			Watt	CRI	Power Factor	Diam	Depth	Back Plate	Carton QTY
	3000K	4000K	5000K							
OYSDIM001	1200LM	1300LM	1250LM	15W	80	>0.9	Ø200mm	48mm	Ø175mm	1/20
OYSDIM002	2000LM	2200LM	2100LM	24W	80	>0.9	Ø300mm	40mm	Ø270mm	1/12

- LED Tri-CCT dimmable oyster lights
- Input voltage range: 220-240V AC 50/60Hz
- Constant current inbuilt driver output voltage: 60-80VDC
- Base: metal
- Diffuser: PS
- LED chips: SMD2835 LED
- Power factor: >0.9
- Tri-CCT (3000K/ 4000K/5000K) in one fitting
- CRI: 80
- Ambient temperature: -20 to 40°C
- Suitable for dimming
- Suitable for 2-way switching
- Suitable for use with 3 wire motion or microwave sensors
- Changes to appearance due to climatic conditions not covered under warranty



Tested & Recommended Dimmers:

Brand	Part No.
HPM	CAT250L, CAT250T & CAT400T
CLIPSAL	32E450UDM, 31E2PUDM, 32E450LM, 32ELEDM-WE & 32E450TM
DIGINET	MEDM, MMDM/RT
HPM	CAT250L

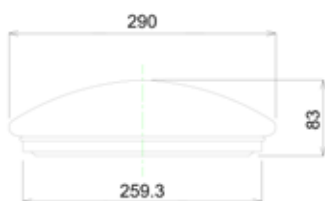

OYSDIM003

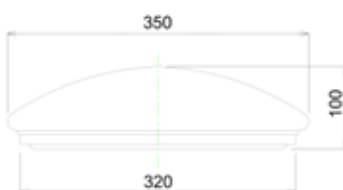

OYSDIM004

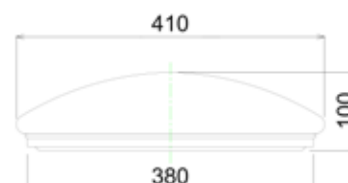

OYSDIM005

Part No.	Lumens			Watt	CRI	Power Factor	Diam	Depth	Back Plate	Carton QTY
	3000K	4000K	5000K							
OYSDIM003	960LM	1140LM	1020LM	12W	80	>0.9	Ø290mm	83mm	Ø259.3mm	1/10
OYSDIM004	1400LM	1650LM	1500LM	18W	80	>0.9	Ø350mm	100mm	Ø320mm	1/10
OYSDIM005	1700LM	2000LM	1800LM	24W	80	>0.9	Ø410mm	100mm	Ø380mm	1/8



- LED dimmable surface mounted oyster lights
- Input voltage range: 220-240V
- Inbuilt constant current driver included
- Housing & faceplate: PC
- Diffuser: white PS
- Mounting bracket: aluminium
- Tri-CCT (3000K/ 4000K/ 5000K) in one fitting
- CCT switch on DC cable
- LED chips: SMD2835
- Power factor: 0.9
- CRI: ≥80
- Flex & plug not included
- Ambient temperature: -20 to 40°C
- Suitable for dimming
- Suitable for 2-way switching
- Suitable for use with motion or Microwave sensors

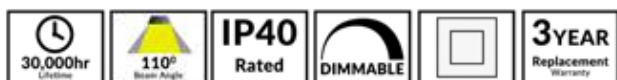

Tested & Recommended Dimmers:

BRAND	PART NO.
CLA	VELA
CLIPSAL	32E450UDM, 31E2PUDM, 32ELEDDM-WE, 32E450TM, PDL354PBDMUN-VW
HPM	Cat 250T, Cat 400T
Diginet	MEDM, MMDM/RT

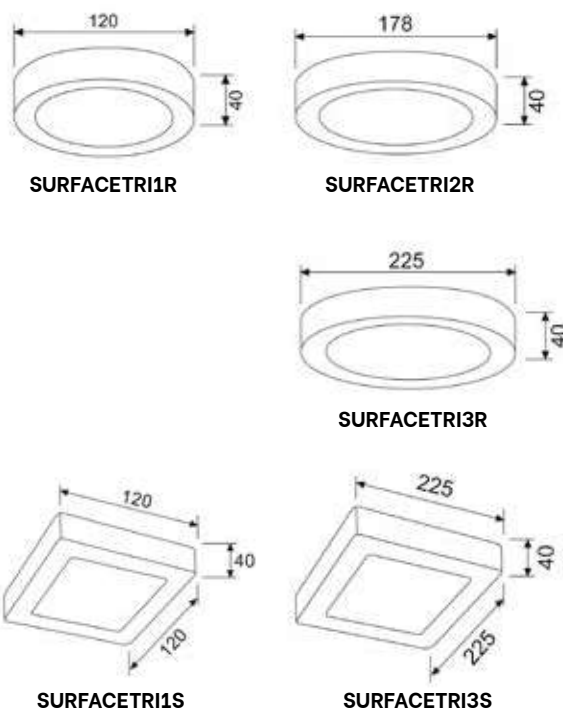

Part No.	Description	Lumens			Watt	CRI	Carton QTY
		3000K	4000K	5000K			
SURFACETRI1R	OYSTER DIMM LED S/M WH RND TRI	420LM	480LM	450LM	6W	≥80	1/40
SURFACETRI2R	OYSTER DIMM LED S/M WH RND TRI	840LM	960LM	900LM	12W	≥80	1/40
SURFACETRI3R	OYSTER DIMM LED S/M WH RND TRI	1350LM	1550LM	1450LM	18W	≥80	1/20
SURFACETRI1S	OYSTER DIMM LED S/M WH SQ TRI	420LM	480LM	450LM	6W	≥80	1/40
SURFACETRI3S	OYSTER DIMM LED S/M WH SQ TRI	1350LM	1550LM	1450LM	18W	≥80	1/20



**GENERAL LIGHTING
BATTENS**



- Interior LED dimmable Tri-CCT surface mounted battens
- Input voltage range: 220-240V AC 50/60Hz
- Constant current inbuilt driver included
- Housing: powder coated aluminium
- Diffuser: PC
- Heat sink: aluminium
- Tri-CCT (3000K/ 4000K/ 5000K) in one fitting
- LED chips: SMD2835
- Power factor: ≥ 0.9
- CRI: >80
- Ambient temperature: -20 to 40°C
- Suitable for dimming
- Suitable for 2-way switching
- Suitable for use with 3 wire motion or Microwave sensors



Tested & Recommended Dimmers:

Brand	Part No.
DIGINET	LEDsmart: MMDM/BP, MMDM/RT
Clipsal	Universal: 32ELEDM, 32E45UDM
HPM	CAT400L, CAT400T

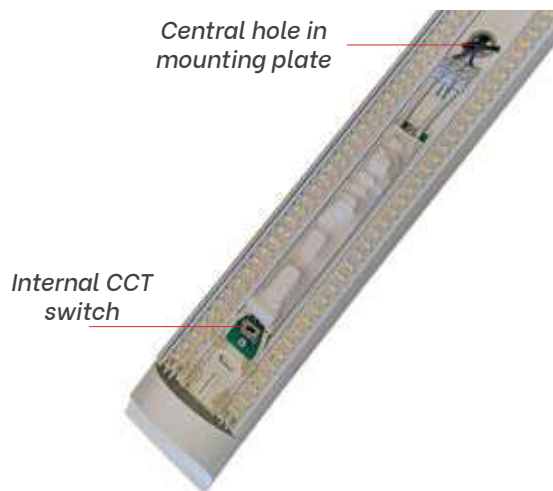

RAZORDM001A

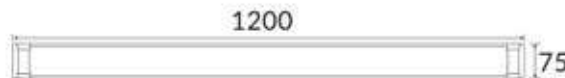

RAZORDM002A

Part No.	Lumens			LED Chips	Watt	CRI	Length	Width	Depth	Carton QTY
	3000K	4000K	5000K							
RAZORDM001A	1500LM	1700LM	1500LM	240pcs 2835	18W	>80	600mm	75mm	31mm	1/10
RAZORDM002A	3000LM	3400LM	3000LM	480pcs 2835	36W	>80	1200mm	75mm	31mm	1/10



- Interior LED Surface Mounted Dimmable Tri-CCT Battens (Wide)
- Input voltage: 220-240V AC 50/60Hz
- Inbuilt driver included
- Diffuser: PC (white)
- Housing: powder coated aluminium
- Heatsink: aluminium
- High power factor: ≥ 0.9
- Tri-CCT (3000K/ 4000K/ 5000K) in one fitting
- Internal switch (under diffuser)
- Central hole in mounting plate
- LED chips: SMD2835
- CRI: >80
- Ambient temperature: -20 to 40°C
- Suitable for dimming with most trailing edge dimmers
- Suitable for 2-way switching
- Suitable for use with 3 wire Microwave & Motion sensors

Wide Housing: 120mm



Central hole in mounting plate



Internal CCT Switch

Tested & Recommended Dimmers:

Brand	Part No.
CLIPSAL	32E450TM, 32E450UDM 32ELEDM 400W 41E300PBUD2SM-VM
HPM	Cat 400L, Cat400T, MMDM/BP400W, MMDM(RT)400W

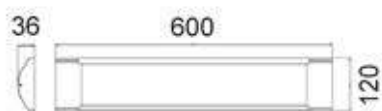

RAZORDMW001



RAZORDMW002

Part No.	Description	Lumens			Watt	CRI	Power Factor	Dimensions	Carton QTY
		3000K	4000K	5000K					
RAZORDMW001	BATTEN LED S/M WH DIMM Central Hole 1700Lm TRI	1500LM	1700LM	1500LM	18W	>80	≥ 0.9	600x120mm	1/10
RAZORDMW002	BATTEN LED S/M WH DIMM Central Hole 3400Lm TRI	3000LM	3400LM	3000LM	36W	>80	≥ 0.9	1200x120mm	1/10



- Exterior LED waterproof **DUAL POWER TRI-CCT** battens
- Input voltage range: 220-240V 50Hz
- Inbuilt Constant Current LED driver
- Housing & diffuser: PC
- Tri-CCT (3000K/ 4000K/ 5000K) in one fitting
- Tri-CCT switch on internal driver
- Wattage switch inside driver
- LED chips: 120pcs or 240pcs SMD2835
- CRI: >80
- Power factor: 0.9
- Ambient temperature: -20 to 40°C
- Suitable for 2-way switching
- Suitable for use with 3 wire motion or Microwave sensors
- Includes: 2xMounting brackets(SS grade 304);
1xConnector(IP65)



SHIELDTRI1
SHIELDTRI2



Back plate



SHIELDTRI1

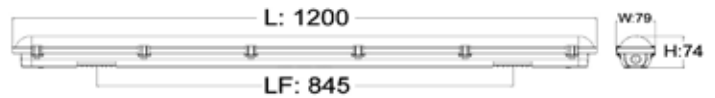

SHIELDTRI2

Part No.	Description	Lumens				Dimensions	Carton QTY
		3000K		4000K			
SHIELDTRI1	BATTEN LED S/M TRIP-ROOF 9W/18W	9W	18W	9W	18W	600x80x75 mm	1/10
		800LM	1600LM	1000LM	2000LM		
SHIELDTRI2	BATTEN LED S/M TRIP-ROOF 18W/36W	18W	36W	18W	36W	1200x80x75 mm	1/10
		1750LM	3500LM	2000LM	4000LM		





GENERAL LIGHTING
CONNECTABLE TRACK SYSTEMS

GU10 Track Heads Connectable Track Systems

- Interior GU10 universal track head lights
- Suitable for universal track
- Input voltage range: 100-240V
- Material: aluminium
- Colour: black and white
- Lamp holder: 1xGU10 (Max.50W)
- Globe not included
- Tilt: 90° / Swivel: 328°
- **Globe grabber/suction cap included**



TRKB3G002
TRKB1G002



TRKW3G002
TRKW1G002

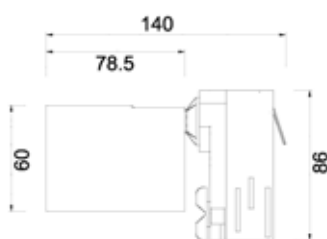

TRKB3G002 &
TRKW3G002



TRKB1G002 &
TRKW1G002

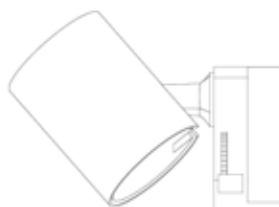
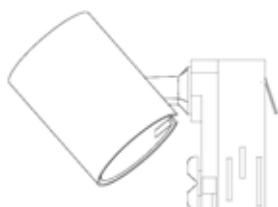

4 WIRE 3 CIRCUIT TRACK HEAD LIGHTS:

Part No.	Description	Carton QTY
TRKB3G002	TRACK Head 4 WIRE 3 Circuit GU10 BLK (No Globes) (Suitable for Universal Track)	1/50
TRKW3G002	TRACK Head 4 WIRE 3 Circuit GU10 WH (No Globes) (Suitable for Universal Track)	1/50

3 WIRE 1 CIRCUIT TRACK HEAD LIGHTS:

Part No.	Description	Carton QTY
TRKB1G002	TRACK Head 1 Circuit GU10 BLK (No Globes) IP20 (Suitable for Universal Track)	1/50
TRKW1G002	TRACK Head 1 Circuit GU10 WH (No Globes) IP20 (Suitable for Universal Track)	1/50

LED Track Heads Connectable Track Systems

- Input voltage: 220-240V
- Faceplate & housing: PC
- Diffuser: PMMA
- Heatsink: aluminium
- Tri-CCT: 2700K/ 4000K/ 6000K in one fitting
- LED chip: 1pc COB LED
- Rear switch
- Power factor: 0.9
- CRI: ≥90
- Tilt: 90° / Swivel: 355°
- Ambient temperature: -20 to 40°C
- Suitable for dimming
- Suitable for 2-way switching



Tested & Recommended Dimmers:

Brand	Part No.
CLA	VELA
CLIPSAL	32ELEDM, 32E45UDM
DIGINET	MEDM
HPM LEGRAND	EM400TRWE

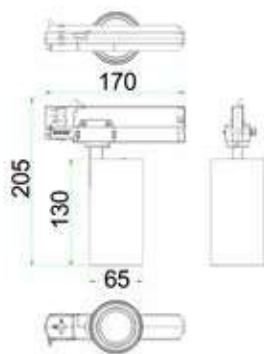

Part No.	Description	Lumens			Watt	CRI	Carton QTY
		2700K	4000K	6000K			
TRKTRIO1	TRACK 4 WIRE 3 Circuit LED HEAD BLK	1120lm	1260lm	1220lm	15W	≥90	1/16
TRKTRIO2	TRACK 4 WIRE 3 Circuit LED HEAD WH	1250lm	1420lm	1370lm	15W	≥90	1/16



These modular LED track heads with their quick assembly and tool-free replacement design, reduces cost and time. A multitude of available optical accessories like lenses and reflectors offer customization to suit various lighting needs.

- 4 wire 3 circuit LED Tri-CCT dimmable Track head lights & accessories
- Input voltage: 220-240V
- Faceplate & housing: powder coated aluminium
- Diffuser: glass
- Heatsink: aluminium
- Tri-CCT: 2700K/ 4000K/ 6000K in one fitting
- LED chip: 1pc COB LED
- Rear switch
- Power factor: 0.92
- CRI: ≥90
- Tilt: 90° / Swivel: 355°
- Ambient temperature: -20 to 40°C
- Suitable for dimming
- Suitable for 2-way switching



ZONE1BK
(INCLUDES ZONERING1BK & ZONEREF1)



REAR CCT SWITCH

Tested & Recommended Dimmers:

Brand	Part No.
CLA	VELA
CLIPSAL	32ELEDM, 32E450TM, 31E2RUDM, 32E450UDM
DIGINET	MEDM
SCHNEIDER	SBD200LED, SBDB15RC



Part No.	Description	Lumens			Watt	CRI	Carton QTY
		2700K	4000K	6000K			
ZONE1BK	TRACK 4 WIRE 3 Circuit LED HEAD BLK	2310LM	2580LM	2460LM	30W	≥90	1/8
ZONE1WH	TRACK 4 WIRE 3 Circuit LED HEAD WH	2610LM	2860LM	2770LM	30W	≥90	1/8

TRACK HEAD COMBINATION

(Shown with ZONERING2)

Stay flexible. Simply change the light distribution yourself at any time - without tools and with hands.



Lamp



Front Ring



Honeycomb Mesh



Lens (Stripe Beam Shape)



Lens (Square Beam Shape)



Shade (Partial Spread)



Shade (Wide Spread)



Barn



Ring

TRACK HEAD ACCESSORIES

1. Track Head Rings

INCLUDED



ZONERING1BK
(Standard)

INCLUDED



ZONERING1WH
(Standard)

Standard Ring Set
Included in ZONE1BK or
ZONE1WH
Ø95mm



ZONERING2BK
(Optional)



ZONERING2WH
(Optional)

Optional Ring Set
Ø95mm



2. Track Head Reflector

INCLUDED



ZONEREF1 (Standard)

Standard Reflector
Included in ZONE1BK or ZONE1WH
Aluminium with glass lens
Ø75mm

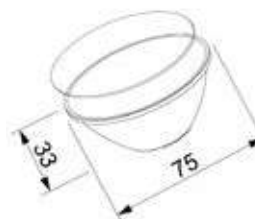

3. Track Head Lens (15° & 36°)



ZONE36LENS1
(Standard)
36D Ø75mm



ZONE15LENS1
(Standard)
15D Ø75mm



ZONE36LENS2
(Optional)
Highlight Soft 36D Ø75mm

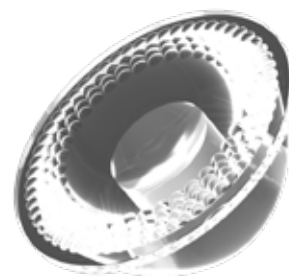

ZONE36LENS3
(Optional)
Gradual Change Soft
36D Ø75mm

4. Track Head Beam Shaping Filters (Ø75mm)

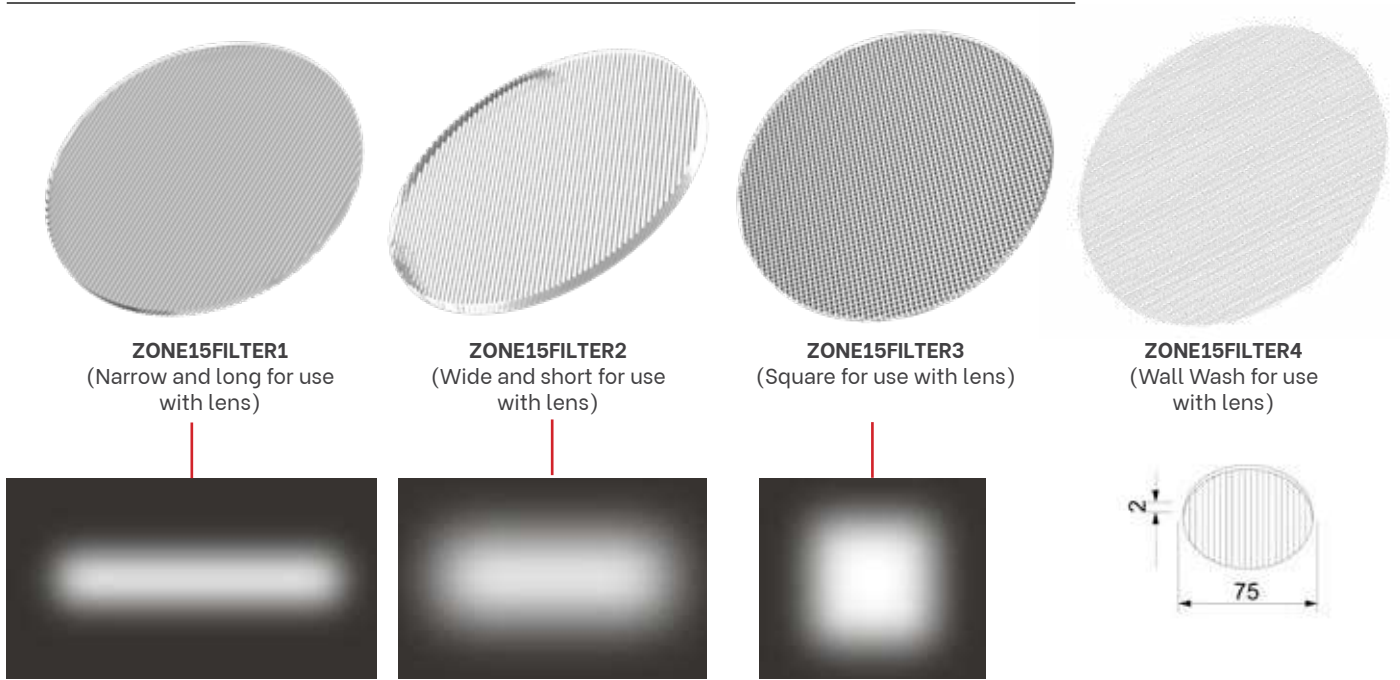

Use the additional accessory to change the light shape. *Can be used with standard ZONERING1 & optional ZONERING2*

5. Track Head Lens Colour Kits

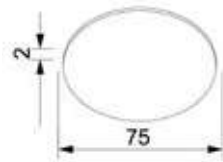

7 Piece colour lens kits (red, green, blue, yellow, orange, purple & tawny)

Material: P/C

For Ring 2 System

Ø75mm

Can be used with standard ZONERING1 & optional ZONERING2



6. Track Head Honeycomb Filter (Anti Glare Mesh Ø75mm)

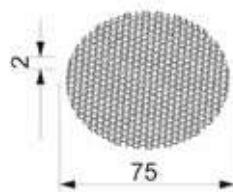
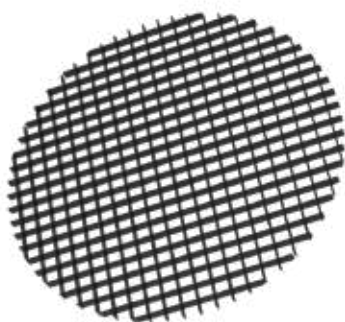

ZONEHONEY
(Optional)

7. Track Head Barns



ZONEBARNBK
(Optional)

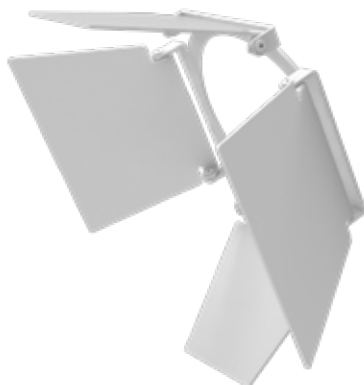

ZONEBARNWH
(Optional)

Barn door
L105 X W105 X H85mm

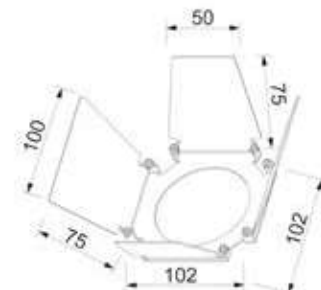

8. Track Head Shades



ZONESHADE1BK
(Optional)



ZONESHADE1WH
(Optional)

Shade (Wide Spread)
Ø75mm



ZONESHADE2BK
(Optional)



ZONESHADE2WH
(Optional)

Shade (Partial)
Ø75mm

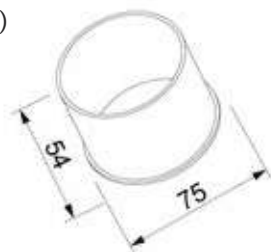



FRONT RINGS

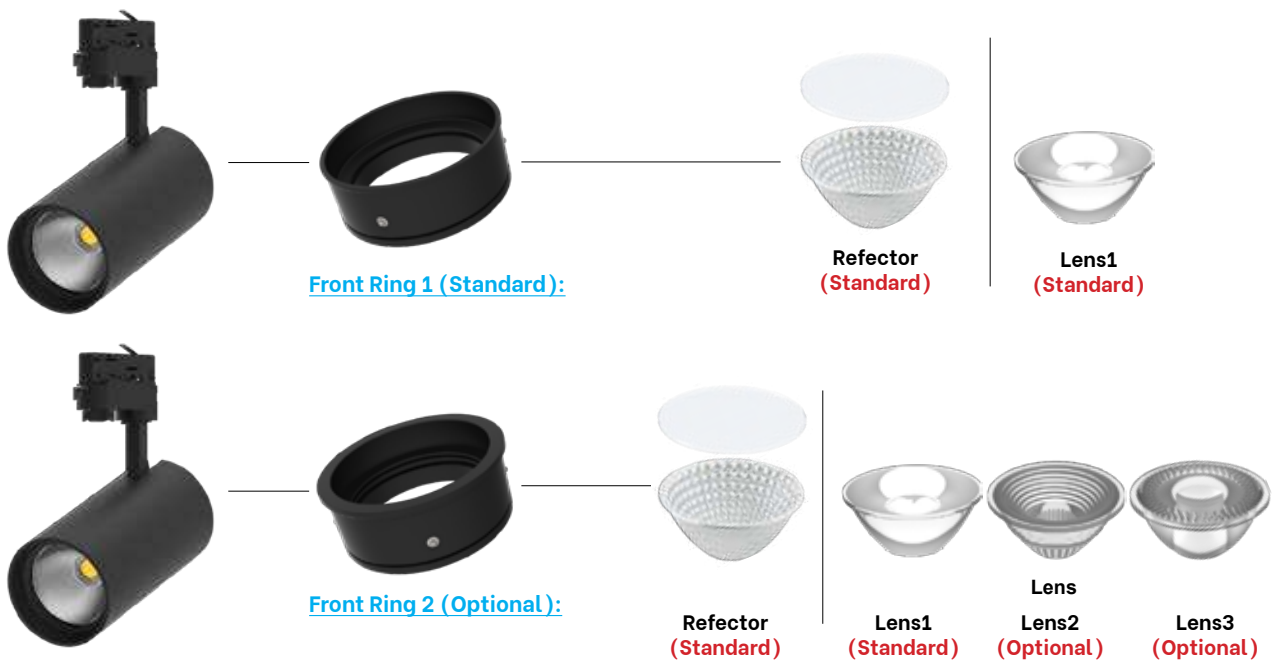

For more information, please visit the link below to watch the instruction video:
<https://youtu.be/GZi3S-9qEkk>

4 Wire 3 Circuit Track & Accessories Connectable Track Systems

4 Wire 3-Circuit Track

- Input voltage range: 220-240V/ 16A
- Material: PC and aluminium
- Colour: black and white
- Universal track



TRK3BL1M
TRK3BL2M



TRK3WH1M
TRK3WH2M

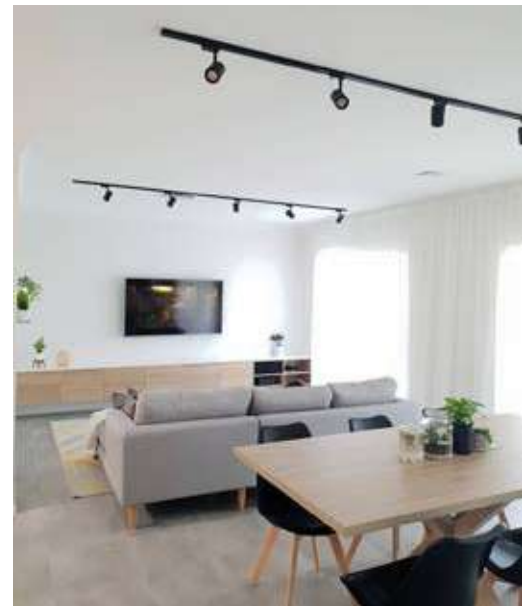
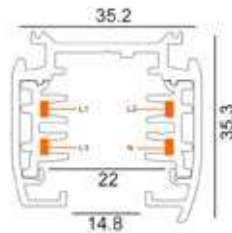

Part No.	Description	Dimensions	Carton QTY
TRK3BL1M	TRACK 3 Circuit 4 Wire 1M BLK (incl LIVE TRK3BLLIVER & END CAP TRK3BLEND)	L1000xW35.2xH35.51mm	1/12
TRK3BL2M	TRACK 3 Circuit 4 Wire 2M BLK (incl LIVE TRK3BLLIVER & END CAP TRK3BLEND)	L2000xW35.2xH35.51mm	1/12
TRK3WH1M	TRACK 3 Circuit 4 Wire 1M WH (incl LIVE TRK3WHLIVER & END CAP TRK3WHEND)	L1000xW35.2xH35.51mm	1/12
TRK3WH2M	TRACK 3 Circuit 4 Wire 2M WH (incl LIVE TRK3WHLIVER & END CAP TRK3WHEND)	L2000xW35.2xH35.51mm	1/12

4 Wire 3-Circuit Track Straight Connectors



TRK3BLCON1



TRK3WHCON1



TRK3BLCON2



TRK3WHCON2

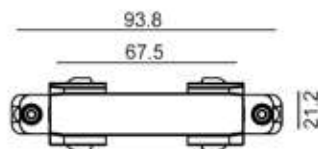

TRK3BLCON1
TRK3WHCON1

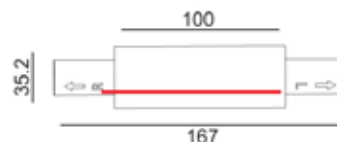

TRK3BLCON2
TRK3WHCON2

Part No.	Description	Carton QTY
TRK3BLCON1	TRACK 3 Circuit 4 Wire Mini Straight Connector BLK	1/100
TRK3BLCON2	TRACK 3 Circuit 4 Wire Straight Connector BLK	1/100
TRK3WHCON1	TRACK 3 Circuit 4 Wire Mini Straight Connector WH	1/100
TRK3WHCON2	TRACK 3 Circuit 4 Wire Straight Connector WH	1/100

4 Wire 3-Circuit Track 'L-Piece' Connectors (Left or right)



TRK3BLCON3R
TRK3BLCON3L



TRK3WHCON3R
TRK3WHCON3L

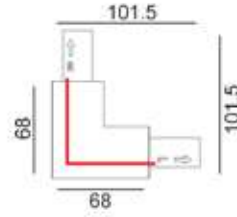

TRK3BLCON3L
TRK3WHCON3L

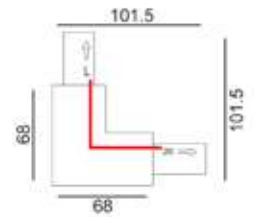

TRK3BLCON3R
TRK3WHCON3R

Part No.	Description	Carton QTY
TRK3BLCON3L	TRACK 3 Circuit 4 Wire L-Piece Connector - LEFT BLK	1/30
TRK3BLCON3R	TRACK 3 Circuit 4 Wire L-Piece Connector - RIGHT BLK	1/30
TRK3WHCON3L	TRACK 3 Circuit 4 Wire L-Piece Connector - LEFT WH	1/30
TRK3WHCON3R	TRACK 3 Circuit 4 Wire L-Piece Connector - RIGHT WH	1/30

4 Wire 3-Circuit Track 'T-Piece' Connectors (Left or right)



TRK3BLCON4L1
TRK3BLCON4L2
TRK3BLCON4R1
TRK3BLCON4R2



TRK3WHCON4L1
TRK3WHCON4L2
TRK3WHCON4R1
TRK3WHCON4R2

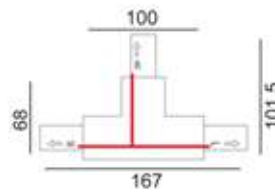

TRK3BLCON4L1
TRK3WHCON4L1

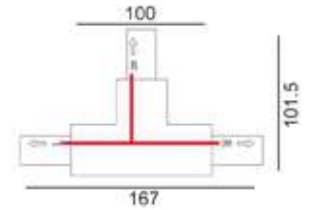

TRK3BLCON4L2
TRK3WHCON4L2

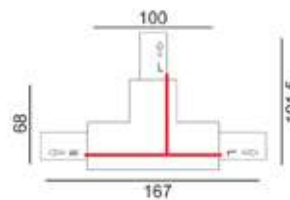

TRK3BLCON4R1
TRK3WHCON4R1

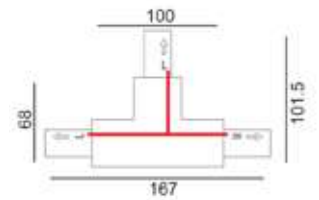

TRK3BLCON4R2
TRK3WHCON4R2

Part No.	Description	Carton QTY
TRK3BLCON4L1	TRACK 3 Circuit 4 Wire T-Piece Connector - LEFT1 BLK	1/30
TRK3BLCON4L2	TRACK 3 Circuit 4 Wire T-Piece Connector - LEFT2 BLK	1/30
TRK3BLCON4R1	TRACK 3 Circuit 4 Wire T-Piece Connector - RIGHT1 BLK	1/30
TRK3BLCON4R2	TRACK 3 Circuit 4 Wire T-Piece Connector - RIGHT2 BLK	1/30
TRK3WHCON4L1	TRACK 3 Circuit 4 Wire T-Piece Connector - LEFT1 WH	1/30
TRK3WHCON4L2	TRACK 3 Circuit 4 Wire T-Piece Connector - LEFT2 WH	1/30
TRK3WHCON4R1	TRACK 3 Circuit 4 Wire T-Piece Connector - RIGHT1 WH	1/30
TRK3WHCON4R2	TRACK 3 Circuit 4 Wire T-Piece Connector - RIGHT2 WH	1/30

4 Wire 3-Circuit Track 'Cross-Piece' & Elbow Connectors

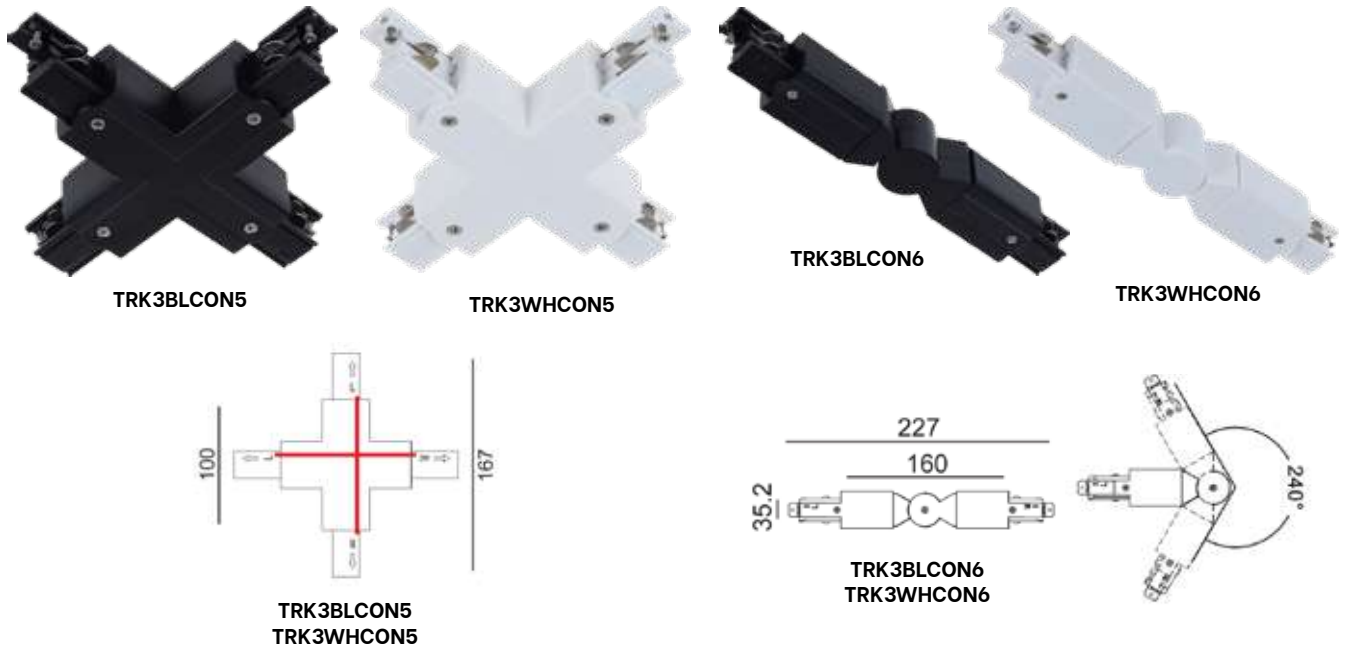

Part No.	Description	Carton QTY
TRK3BLCON5	TRACK 3 Circuit 4 Wire Cross-Piece Connector BLK	1/30
TRK3BLCON6	TRACK 3 Circuit 4 Wire Elbow Connector BLK	1/30
TRK3WHCON5	TRACK 3 Circuit 4 Wire Cross-Piece Connector WH	1/30
TRK3WHCON6	TRACK 3 Circuit 4 Wire Elbow Connector WH	1/30

4 Wire 3-Circuit Track Flexible Connector



Part No.	Description	Carton QTY
TRK3BLFLEXCON	TRACK 3 Circuit 4 Wire Flexible Connector BLK	1/1
TRK3WHFLEXCON	TRACK 3 Circuit 4 Wire Flexible Connector WH	1/1

**NOTE: Except TRK3BL/WHCON1 & TRK3BL/WHCON6, all our connectors and joiners have center feed facility (ability to connect with power supply)*

4 Wire 3-Circuit Track End Cap & Live End (Left or right)

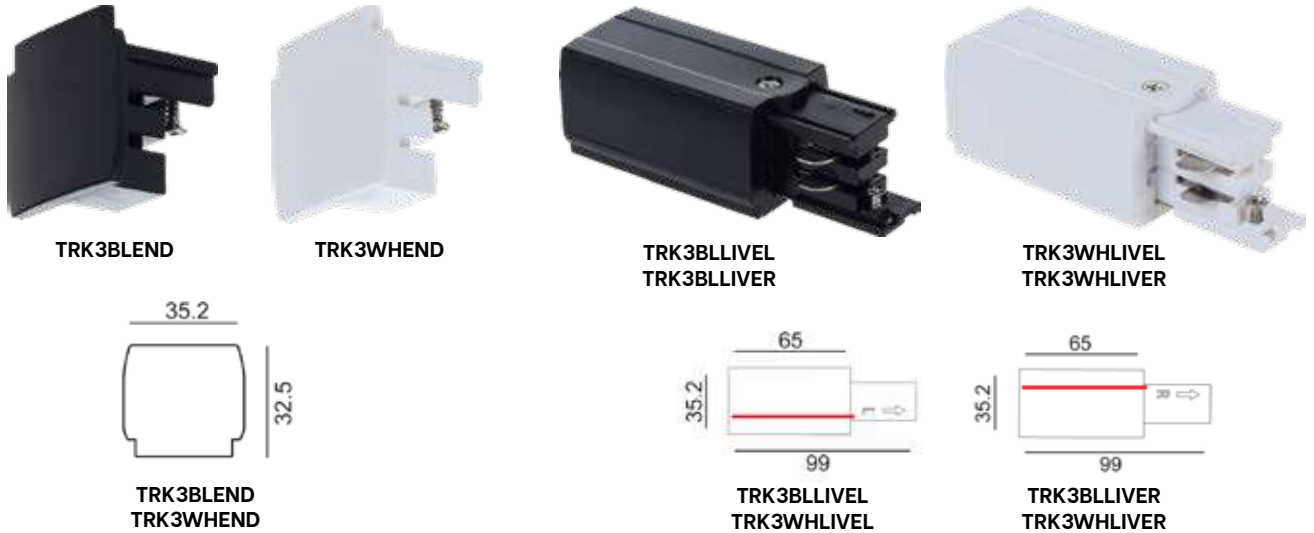

Part No.	Description	Carton QTY
TRK3BLEND	TRACK 3 Circuit 4 Wire End Cap BLK	1/100
TRK3BLLLEVEL	TRACK 3 Circuit 4 Wire TRACK LIVE END - LEFT BLK	1/100
TRK3BLLIVER	TRACK 3 Circuit 4 Wire TRACK LIVE END - RIGHT BLK	1/100
TRK3WHEND	TRACK 3 Circuit 4 Wire End Cap WH	1/100
TRK3WHLLEVEL	TRACK 3 Circuit 4 Wire TRACK LIVE END - LEFT WH	1/100
TRK3WHLIVER	TRACK 3 Circuit 4 Wire TRACK LIVE END - RIGHT WH	1/100

4 Wire 3-Circuit Track Ceiling Kits

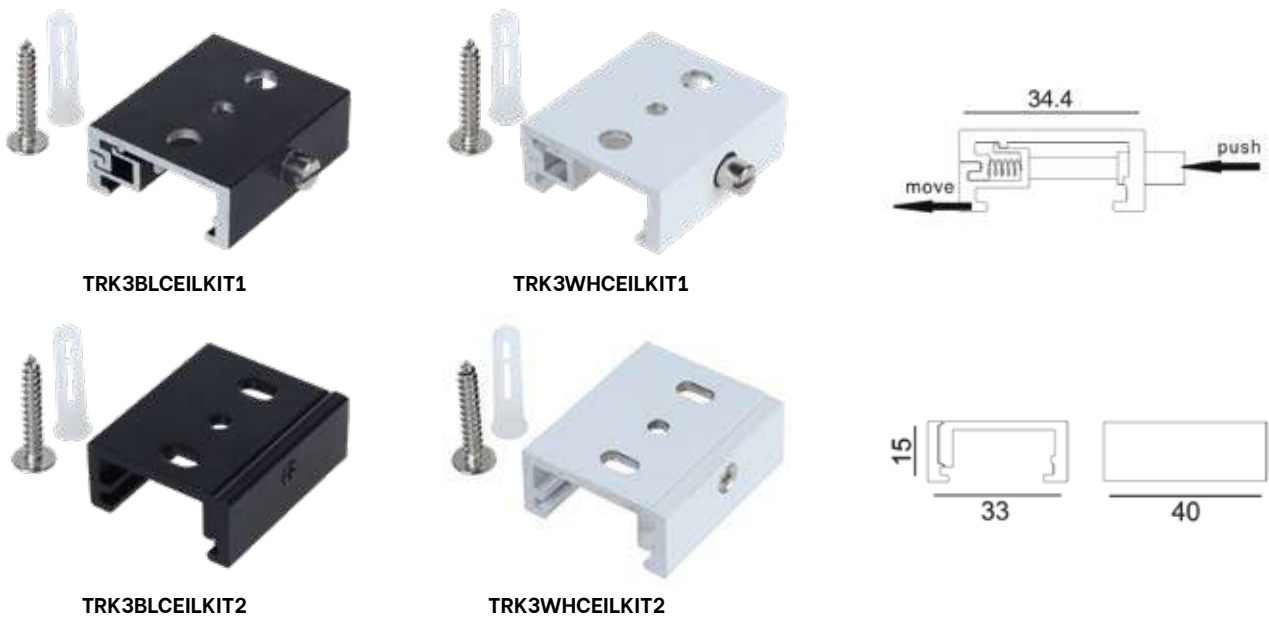

Part No.	Description	Carton QTY
TRK3BLCEILKIT1	TRACK 3 Circuit 4 Wire Ceiling Kit With Spring BLK	1/1
TRK3BLCEILKIT2	TRACK 3 Circuit 4 Wire Ceiling Clamp Kit For Track Connection BLK	1/1
TRK3WHCEILKIT1	TRACK 3 Circuit 4 Wire Ceiling Kit With Spring WH	1/1
TRK3WHCEILKIT2	TRACK 3 Circuit 4 Wire Ceiling Clamp Kit For Track Connection WH	1/1

4 Wire 3-Circuit Track Installation:

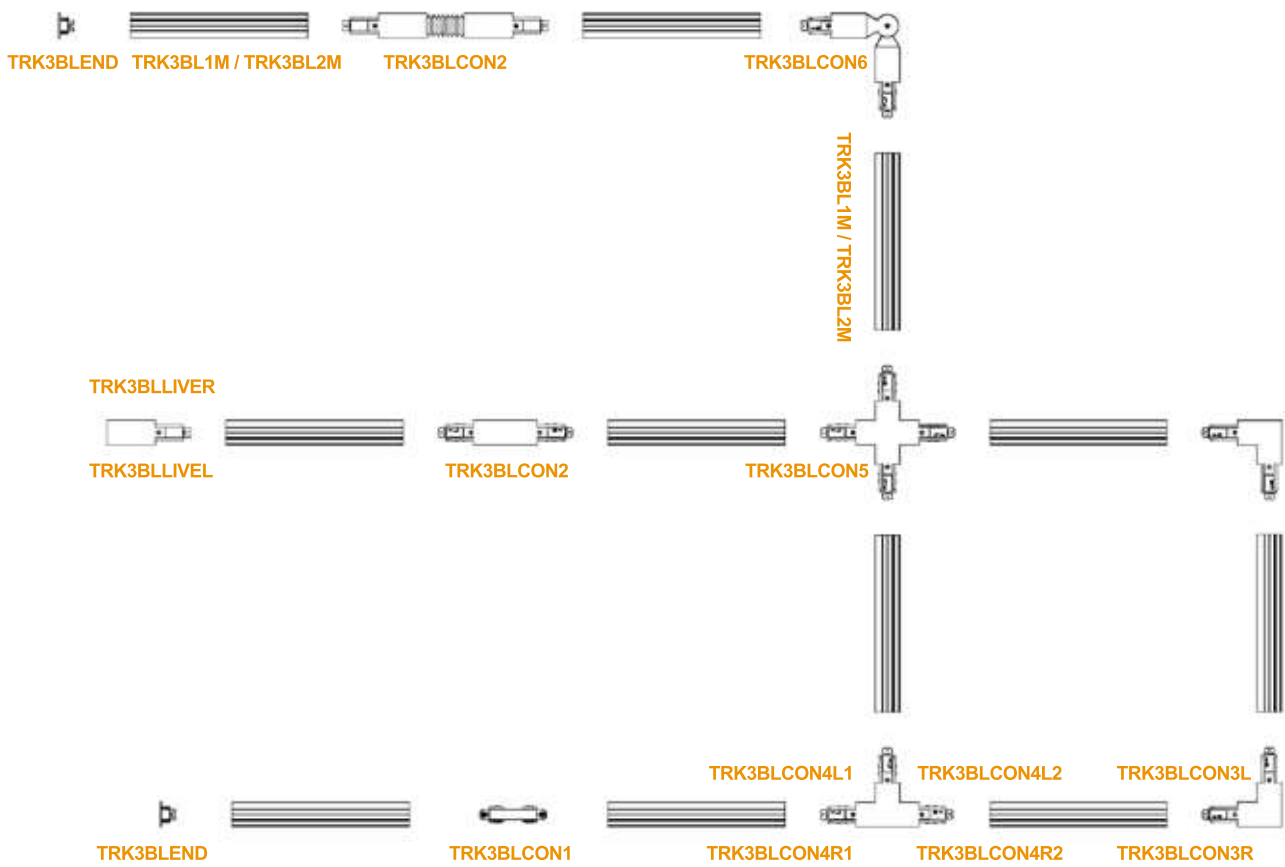

Installation :

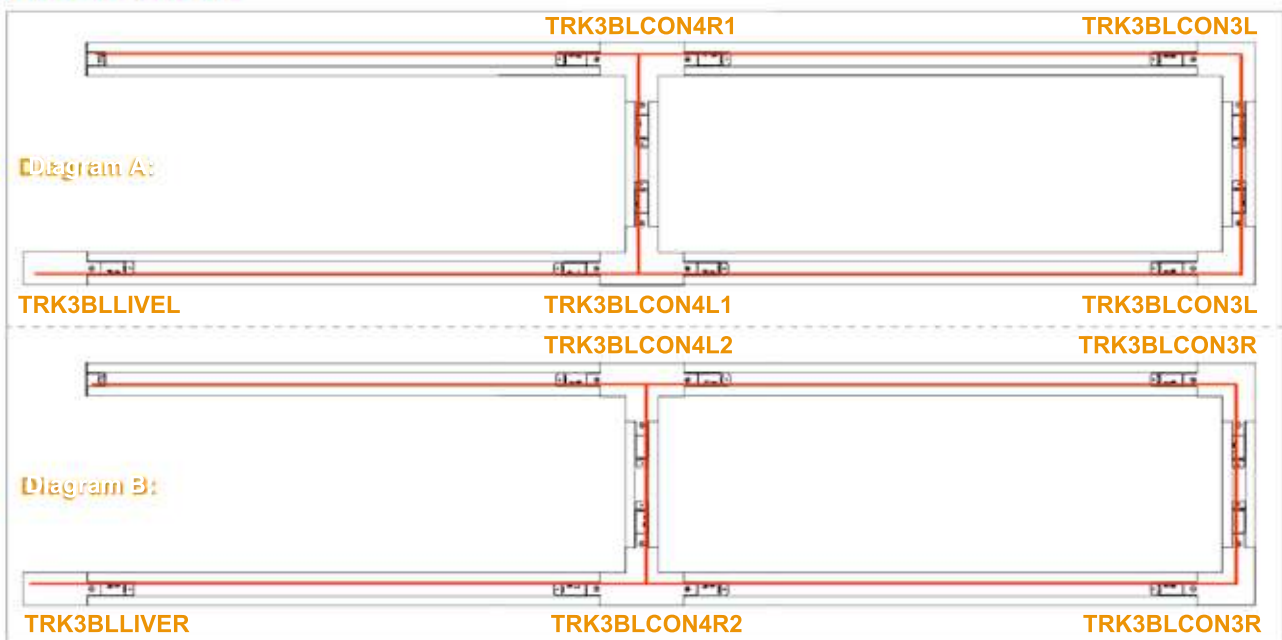

4 Wire 3-Circuit Track Pendant Light Adaptors



TRK3BLADAP3
TRACK 3 Circuit 4 Wire Adaptor Big
Hold Weight 10Kg Max BLK



TRK3WHADAP3
TRACK 3 Circuit 4 Wire Adaptor Big
Hold Weight 10Kg Max WH

- For 4 wire 3 circuit track
- Hold weight: 10kg Max
- Colour: black and white
- To be used with split nipple (Part No. TRK3BL/WHNIPCON sold separately)
- Warranty: 3 year replacement



TRK3BLADAP4
TRACK 3 Circuit 4 Wire Adaptor Small
Hold Weight 5Kg Max BLK



TRK3WHADAP4
TRACK 3 Circuit 4 Wire Adaptor Small
Hold Weight 5Kg Max WH

- For 4 wire 3 circuit track
- Hold weight: 5kg Max
- Colour: black and white
- To be used with split nipple (Part No. TRK3BL/WHNIPCON sold separately)
- Warranty: 3 year replacement

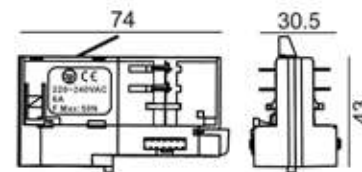

4 Wire 3-Circuit Track Split Nipple Connector



TRK3BLNIPCON
TRACK 3 Circuit 4 Wire Split Nipple
Connector BLK



TRK3WHNIPCON
TRACK 3 Circuit 4 Wire Split Nipple
Connector WH

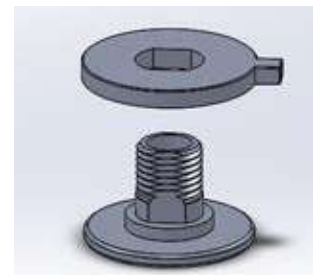

4 Wire 3-Circuit Track Suspension Kits



TRK3BLSUSKIT1
TRACK 3 Circuit 4 Wire Suspension Mount Kit (With 1.5m Steel Wire) BLK



TRK3WHSUSKIT1
TRACK 3 Circuit 4 Wire Suspension Mount Kit (With 1.5m Steel Wire) WH

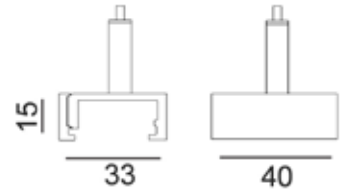

TRK3BLSUSKIT2
TRACK 3 Circuit 4 Wire Suspension Mount Ezclick Kit (With 1.5m Steel Wire) BLK



TRK3WHSUSKIT2
TRACK 3 Circuit 4 Wire Suspension Mount Ezclick Kit (With 1.5m Steel Wire) WH

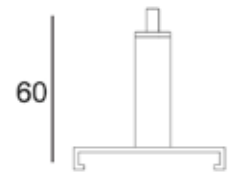

Rod(1m) →



TRK3BLSUSKIT3
TRACK 3 Circuit 4 Wire Suspension Mount Rod Kit With M6x1 Metre Threaded Rod BLK

Rod(1m) →



TRK3WHSUSKIT3
TRACK 3 Circuit 4 Wire Suspension Mount Rod Kit With M6x1 Metre Threaded Rod WH

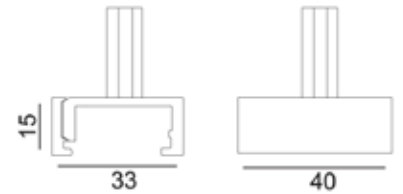

Rod(1m) →



TRK3BLSUSKIT4
TRACK 3 Circuit 4 Wire Suspension Mount Ezclick Kit With M6x1 Metre Threaded Rod BLK

Rod(1m) →



TRK3WHSUSKIT4
TRACK 3 Circuit 4 Wire Suspension Mount Ezclick Kit With M6x1 Metre Threaded Rod WH

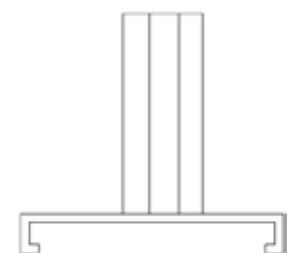



TRK3BLSUSKIT5

TRACK 3 Circuit 4 Wire Suspension Kit With Spring (Added With 1.5m Steel Wire) BLK



TRK3WHSUSKIT5

TRACK 3 Circuit 4 Wire Suspension Kit With Spring (Added With 1.5m Steel Wire) WH

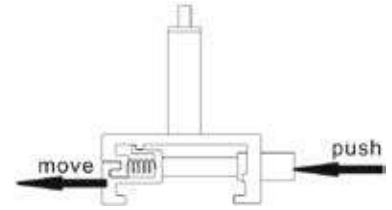

4 Wire 3-Circuit Track Suspension Clamp for Track Connection



TRK3BLSUSCLAMP

TRACK 3 Circuit 4 Wire Suspension Clamp For Track Connection BLK



TRK3WHSUSCLAMP

TRACK 3 Circuit 4 Wire Suspension Clamp For Track Connection WH



3 Wire 1 Circuit Track & Accessories

Connectable Track Systems

3 Wire 1-Circuit Track

- Input voltage range: 220-240V/ 16A
- Material: PC and aluminium
- Colour: black and white
- Universal track



TRK1BL1M
TRK1BL2M



TRK1WH1M
TRK1WH2M

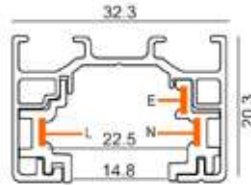

Part No.	Description	Dimensions	Carton QTY
TRK1BL1M	TRACK 1 Circuit 3 Wire 1M BLK (incl LIVE TRK1BLLIVER & END CAP TRK1BLEND)	L1000xW32.3xH20.3mm	1/20
TRK1BL2M	TRACK 1 Circuit 3 Wire 2M BLK (incl LIVE TRK1BLLIVER & END CAP TRK1BLEND)	L2000xW32.3xH20.3mm	1/20
TRK1WH1M	TRACK 1 Circuit 3 Wire 1M WH (incl LIVE TRK1WHLIVER & END CAP TRK1WHEND)	L1000xW32.3xH20.3mm	1/20
TRK1WH2M	TRACK 1 Circuit 3 Wire 2M WH (incl LIVE TRK1WHLIVER & END CAP TRK1WHEND)	L2000xW32.3xH20.3mm	1/20

3 Wire 1-Circuit Track Straight Connectors



TRK1BLCON1



TRK1WHCON1



TRK1BLCON2



TRK1WHCON2

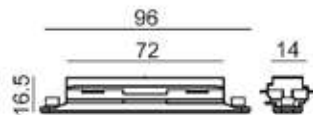

TRK1BLCON1
TRK1WHCON1

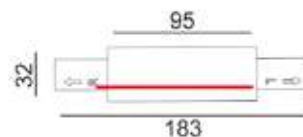

TRK1BLCON2
TRK1WHCON2

Part No.	Description	Carton QTY
TRK1BLCON1	TRACK 1 Circuit 3 Wire Mini Straight Connector BLK	1/100
TRK1BLCON2	TRACK 1 Circuit 3 Wire Straight Connector BLK	1/100
TRK1WHCON1	TRACK 1 Circuit 3 Wire Mini Straight Connector WH	1/100
TRK1WHCON2	TRACK 1 Circuit 3 Wire Straight Connector WH	1/100

3 Wire 1-Circuit Track 'L-Piece' Connectors (Left or right)



TRK1BLCON3R
TRK1BLCON3L



TRK1WHCON3R
TRK1WHCON3L

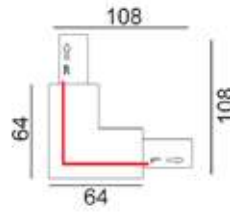

TRK1BLCON3L
TRK1WHCON3L

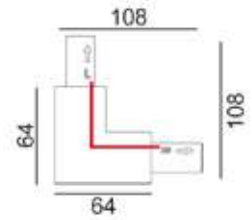

TRK1BLCON3R
TRK1WHCON3R

Part No.	Description	Carton QTY
TRK1BLCON3L	TRACK 1 Circuit 3 Wire L-Piece Connector - LEFT BLK	1/100
TRK1BLCON3R	TRACK 1 Circuit 3 Wire L-Piece Connector - RIGHT BLK	1/100
TRK1WHCON3L	TRACK 1 Circuit 3 Wire L-Piece Connector - LEFT WH	1/100
TRK1WHCON3R	TRACK 1 Circuit 3 Wire L-Piece Connector - RIGHT WH	1/100

3 Wire 1-Circuit Track 'T-Piece' Connectors (Left or right)



TRK1BLCON4L1
TRK1BLCON4L2
TRK1BLCON4R1
TRK1BLCON4R2



TRK1WHCON4L1
TRK1WHCON4L2
TRK1WHCON4R1
TRK1WHCON4R2

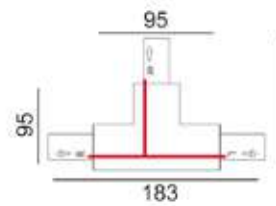

TRK1BLCON4L1
TRK1WHCON4L1

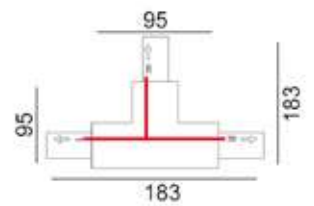

TRK1BLCON4L2
TRK1WHCON4L2

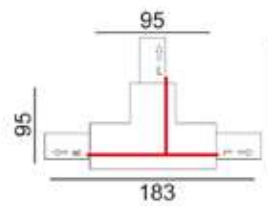

TRK1BLCON4R1
TRK1WHCON4R1

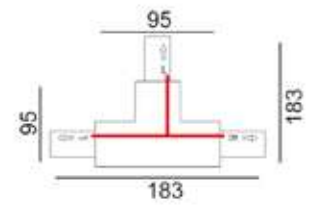

TRK1BLCON4R2
TRK1WHCON4R2

Part No.	Description	Carton QTY
TRK1BLCON4L1	TRACK 1 Circuit 3 Wire T-Piece Connector - LEFT1 BLK	1/100
TRK1BLCON4L2	TRACK 1 Circuit 3 Wire T-Piece Connector - LEFT2 BLK	1/100
TRK1BLCON4R1	TRACK 1 Circuit 3 Wire T-Piece Connector - RIGHT1 BLK	1/100
TRK1BLCON4R2	TRACK 1 Circuit 3 Wire T-Piece Connector - RIGHT2 BLK	1/100
TRK1WHCON4L1	TRACK 1 Circuit 3 Wire T-Piece Connector - LEFT1 WH	1/100
TRK1WHCON4L2	TRACK 1 Circuit 3 Wire T-Piece Connector - LEFT2 WH	1/100
TRK1WHCON4R1	TRACK 1 Circuit 3 Wire T-Piece Connector - RIGHT1 WH	1/100
TRK1WHCON4R2	TRACK 1 Circuit 3 Wire T-Piece Connector - RIGHT2 WH	1/100

3 Wire 1-Circuit Track 'Cross-Piece' & Elbow Connectors

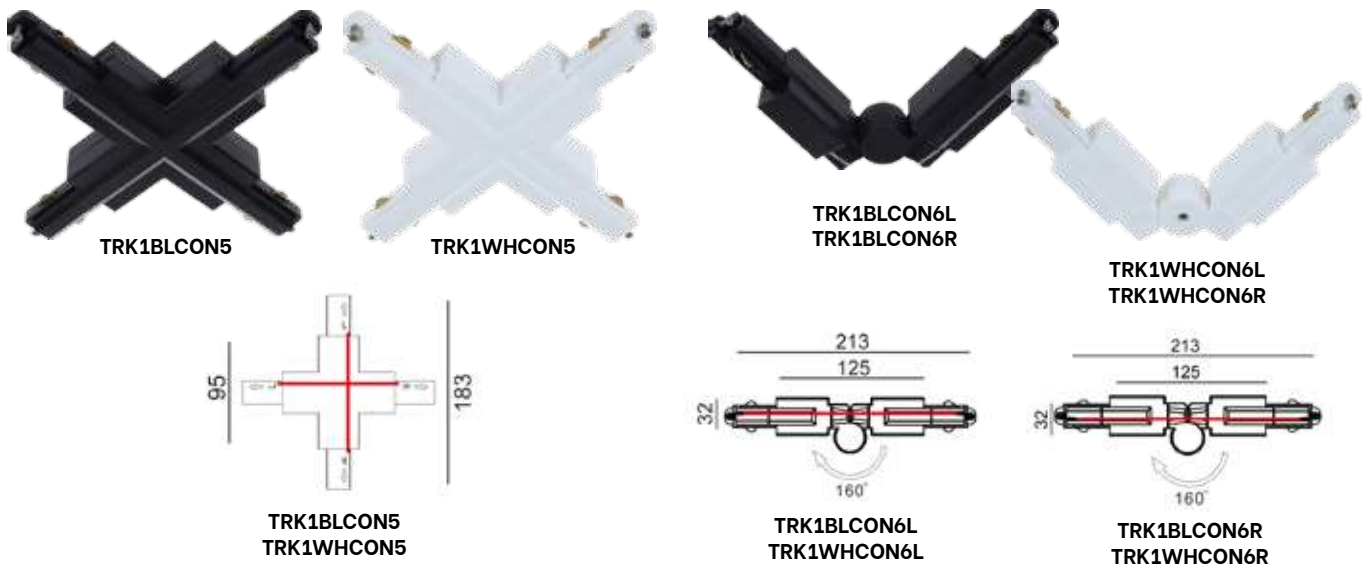

Part No.	Description	Carton QTY
TRK1BLCON5	TRACK 1 Circuit 3 Wire Cross-Piece Connector BLK	1/100
TRK1BLCON6L	TRACK 1 Circuit 3 Wire Elbow Connector- LEFT BLK	1/100
TRK1BLCON6R	TRACK 1 Circuit 3 Wire Elbow Connector- RIGHT BLK	1/100
TRK1WHCON5	TRACK 1 Circuit 3 Wire Cross-Piece Connector WH	1/100
TRK1WHCON6L	TRACK 1 Circuit 3 Wire Elbow Connector- LEFT WH	1/100
TRK1WHCON6R	TRACK 1 Circuit 3 Wire Elbow Connector- RIGHT WH	1/100

3 Wire 1-Circuit Track End Cap & Live End (Left or right)



Part No.	Description	Carton QTY
TRK1BLEND	TRACK 1 Circuit 3 Wire End Cap BLK	1/100
TRK1BLLLIVE	TRACK 1 Circuit 3 Wire TRACK LIVE END - LEFT BLK	1/100
TRK1BLLIVER	TRACK 1 Circuit 3 Wire TRACK LIVE END - RIGHT BLK	1/100
TRK1WHEND	TRACK 1 Circuit 3 Wire End Cap WH	1/100
TRK1WHLIVE	TRACK 1 Circuit 3 Wire TRACK LIVE END - LEFT WH	1/100
TRK1WHLIVER	TRACK 1 Circuit 3 Wire TRACK LIVE END - RIGHT WH	1/100

**NOTE: Except TRK1BL/WHCON1 & TRK1BL/WHCON6L/R, all our connectors and joiners have center feed facility (ability to connect with power supply)*

3 Wire 1-Circuit Track Installation:

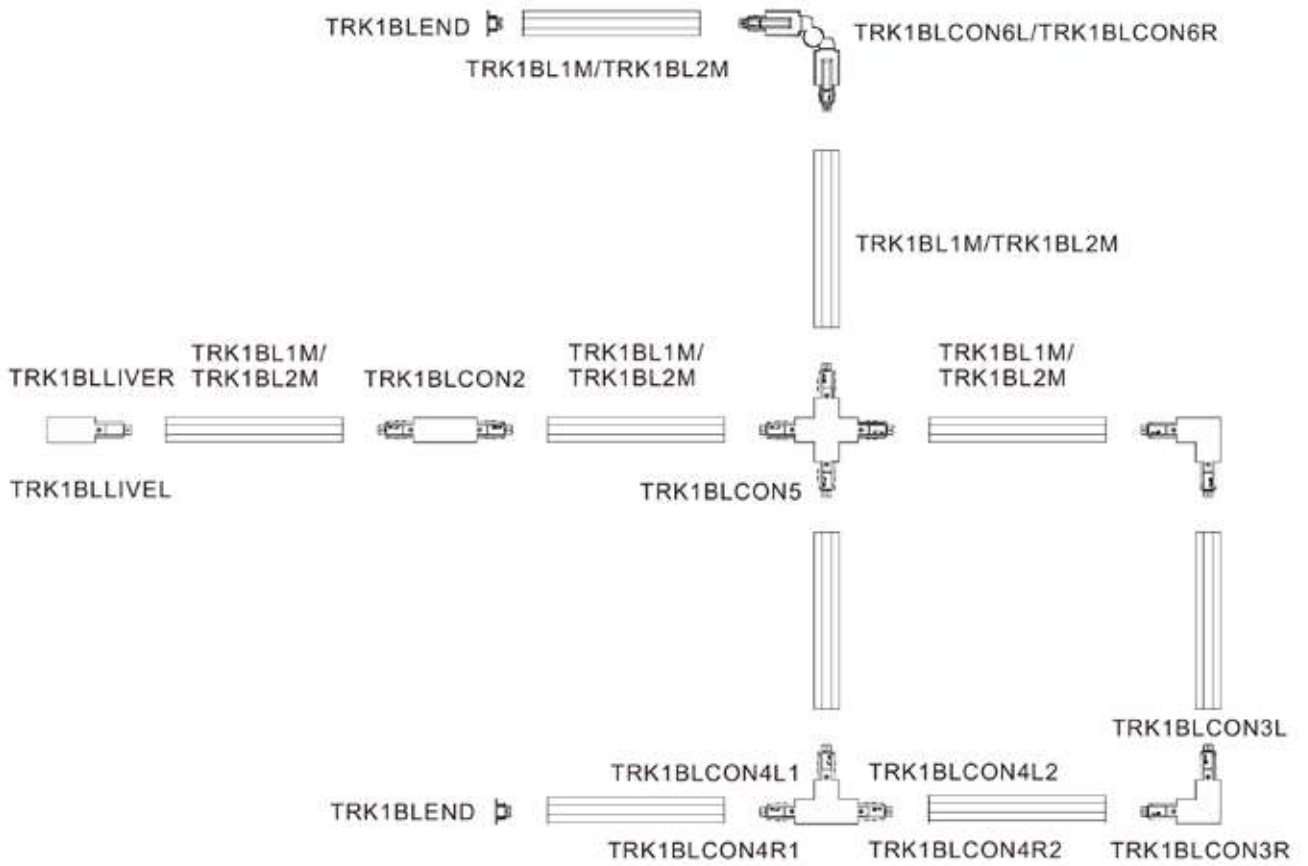

Installation :

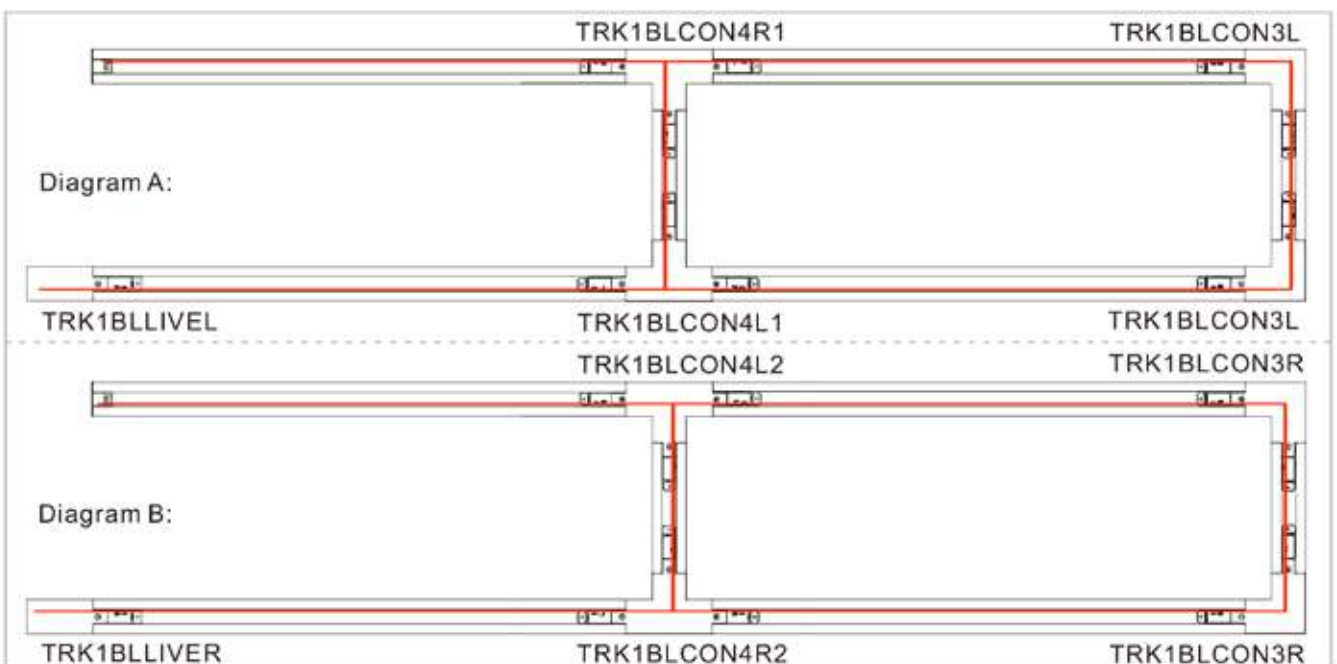

3 Wire 1 Circuit Track Pendant Light Adaptors



TRK1BLADAP1



TRK1WHADAP1

- For 3 wire 1 circuit track
- Hold weight: 5kg Max
- M10x16mm
- Colour: black and white
- Warranty: 3 year replacement



Part No.	Description
TRK1BLADAP1	TRACK 1 Circuit 3 Wire Adaptor Hold Weight 5Kg Max M10x16mm BLK
TRK1WHADAP1	TRACK 1 Circuit 3 Wire Adaptor Hold Weight 5Kg Max M10x16mm WH



TRK1BLADAP2



TRK1WHADAP2

- For 3 wire 1 circuit track
- Hold weight: 5kg Max.
- Colour: black and white
- Warranty: 3 year replacement

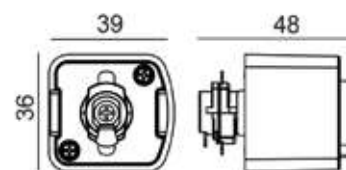

Part No.	Description
TRK1BLADAP2	TRACK 1 Circuit 3 Wire Square Adaptor Hold Weight 5Kg Max BLK
TRK1WHADAP2	TRACK 1 Circuit 3 Wire Square Adaptor Hold Weight 5Kg Max WH



GENERAL LIGHTING
INTERIOR UTILITY LIGHTS

RAZORDM Interior Utility Lights



- Interior LED dimmable Tri-CCT surface mounted battens
- Input voltage range: 220-240V AC 50/60Hz
- Constant current inbuilt driver included
- Housing: powder coated aluminium
- Diffuser: PC
- Heat sink: aluminium
- Tri-CCT (3000K/ 4000K/ 5000K) in one fitting
- LED chips: SMD2835
- Power factor: ≥ 0.9
- CRI: >80
- Ambient temperature: -20 to 40°C
- Suitable for dimming
- Suitable for 2-way switching
- Suitable for use with 3 wire motion or Microwave sensors



Tested & Recommended Dimmers:

Brand	Part No.
DIGINET	LEDSmart: MMDM/BP, MMDM/RT
Clipsal	Universal: 32ELEDM, 32E45UDM
HPM	CAT400L, CAT400T

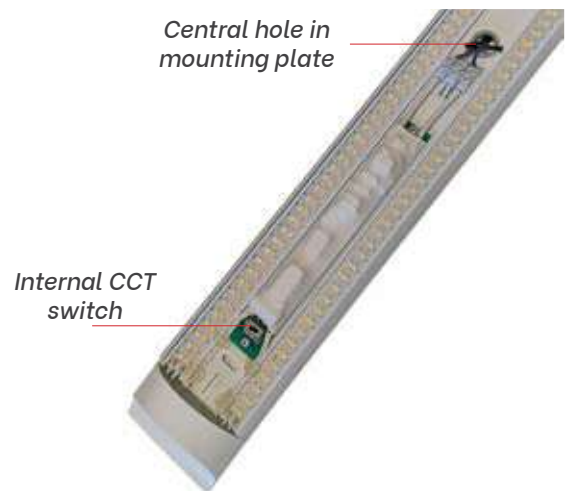

Part No.	Lumens			LED Chips	Watt	CRI	Length	Width	Depth	Carton QTY
	3000K	4000K	5000K							
RAZORDM001A	1500LM	1700LM	1500LM	240pcs 2835	18W	>80	600mm	75mm	31mm	1/10
RAZORDM002A	3000LM	3400LM	3000LM	480pcs 2835	36W	>80	1200mm	75mm	31mm	1/10



- Interior LED Surface Mounted Dimmable Tri-CCT Battens (Wide)
- Input voltage: 220-240V AC 50/60Hz
- Inbuilt driver included
- Diffuser: PC (white)
- Housing: powder coated aluminium
- Heatsink: aluminium
- High power factor: ≥ 0.9
- Tri-CCT (3000K/ 4000K/ 5000K) in one fitting
- Internal switch (under diffuser)
- Central hole in mounting plate
- LED chips: SMD2835
- CRI: >80
- Ambient temperature: -20 to 40°C
- Suitable for dimming with most trailing edge dimmers
- Suitable for 2-way switching
- Suitable for use with 3 wire Microwave & Motion sensors

Wide Housing: 120mm



Central hole in mounting plate



Internal CCT Switch

Tested & Recommended Dimmers:

Brand	Part No.
CLIPSAL	32E450TM, 32E450UDM 32ELEDM 400W 41E300PBUD2SM-VM
HPM	Cat 400L, Cat400T, MMDM/BP400W, MMDM(RT)400W

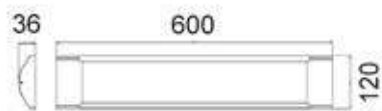

RAZORDMW001

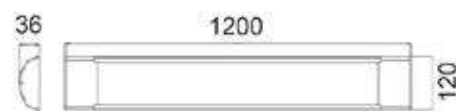

RAZORDMW002

Part No.	Description	Lumens			Watt	CRI	Power Factor	Dimensions	Carton QTY
		3000K	4000K	5000K					
RAZORDMW01	BATTEN LED S/M WH DIMM Central Hole 1700Lm TRI	1500LM	1700LM	1500LM	18W	>80	≥ 0.9	600x120mm	1/10
RAZORDMW02	BATTEN LED S/M WH DIMM Central Hole 3400Lm TRI	3000LM	3400LM	3000LM	36W	>80	≥ 0.9	1200x120mm	1/10



- Interior LED Tri-CCT linkable T5 slimline lights
 - Input voltage range: 220-240V AC 50/60Hz
 - Inbuilt driver
 - Housing: PC
 - Mounting bracket: aluminium
 - LED chips: SMD2835
 - Tri-CCT in one fitting: 3000K / 4000K / 5700K
 - Slide switch on side
 - CRI: ≥80
 - Power factor: >0.9
 - Flex & plug and connecting cables sold separately
 - Hardwire connecting cable and mounting bracket included in the box
 - Not suitable for dimming
 - Ambient temperature: -15 to 40°C
 - Note: All LINKTRI models can be used together.
- Maximum connection wattage: 150W



15mm hardwire connecting cable included in the box



LINKTRICN



LINKTRIFP

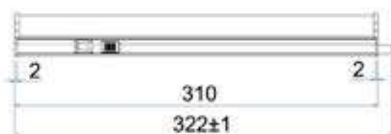

LINKTRIO1

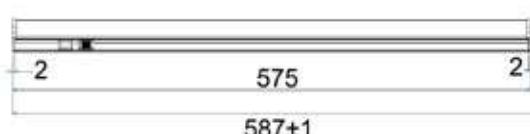
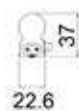

LINKTRIO2



LINKTRIO3

Part No.	Description	Lumens			Watt	CRI	Width	Length	Depth	Carton QTY
		3000K	4000K	5700K						
LINKTRIO1	LINKABLE LED SLIM 4W TRI	380LM	420LM	400LM	4W	80	22.6mm	322mm	37mm	1/40
LINKTRIO2	LINKABLE LED SLIM 9W TRI	855LM	945LM	900LM	9W	80	22.6mm	587mm	37mm	1/40
LINKTRIO3	LINKABLE LED SLIM 18W TRI	1710LM	1890LM	1800LM	18W	80	22.6mm	1187mm	37mm	1/40
LINKTRICN	LINKABLE LED SLIM CONNECTOR 220mm (22cm) FOR LINK TRI SERIES									
LINKTRIFP	LINKABLE LED SLIM F&P 2 PIN 1.2M CABLE FOR LINK TRI SERIES									

NIGHT Interior Utility Lights

- Interior LED utility wall night light
- Input voltage: 220-250V AC
- Inbuilt LED driver
- Automatically Turns on at dusk and off at dawn
- No batteries required
- Rotates through 360° to light any direction
- For indoor use only

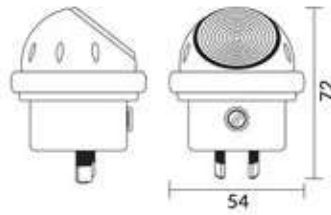

1. For best results, use in a place with ample natural light, unobstructed by window furnishings
2. To use safely, ensure the night light is fully inserted into socket
3. The photoelectric eye will sense fading light and automatically switch the night light on and off again as natural light return

Part No.	Description	Kelvin	Lumens	Watt	CRI	Dimensions	Carton QTY
NIGHT01	WALL INTERNAL LED PLUG IN NIGHTLIGHT	6500K	28LM	0.2w	-	72X54mm	12/96

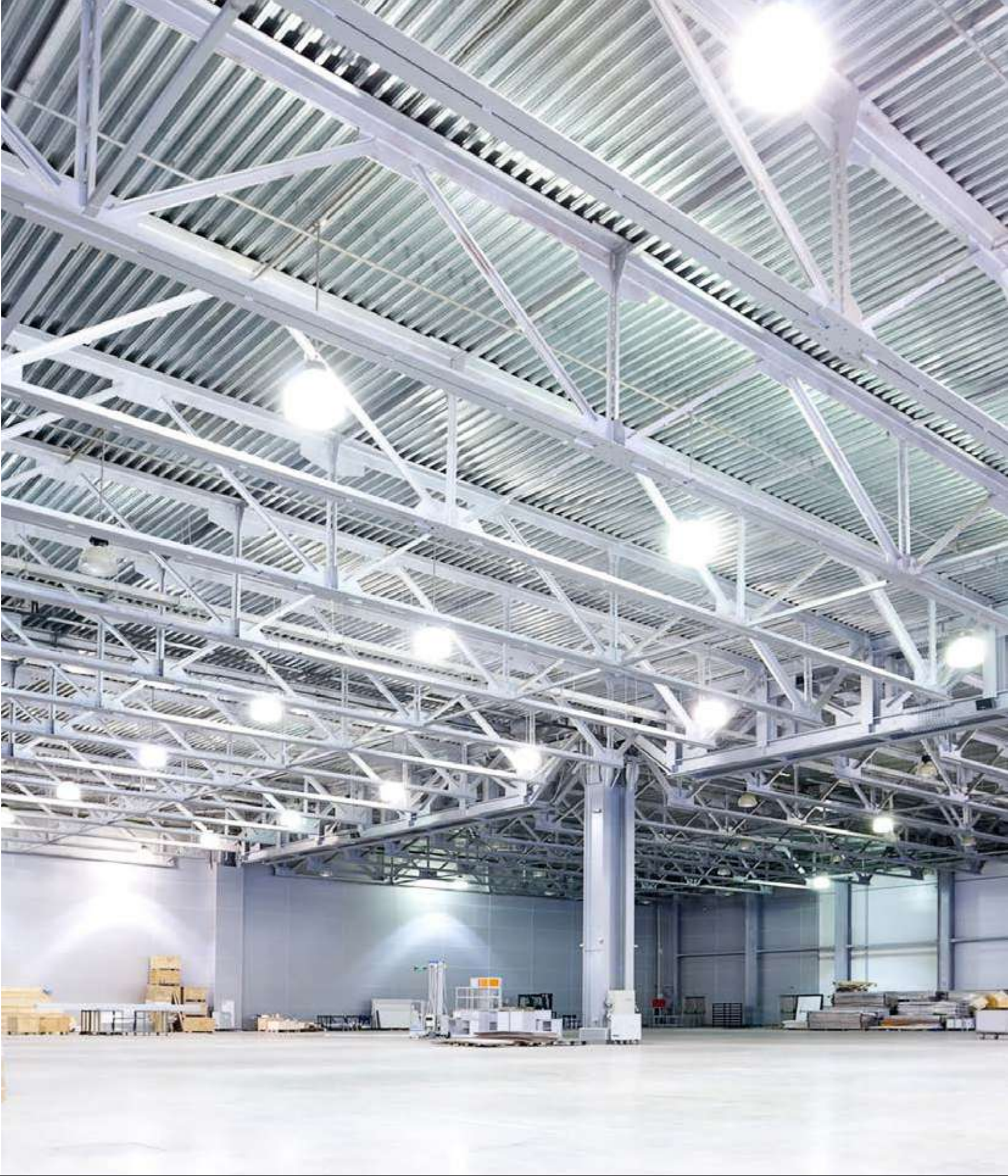

GENERAL LIGHTING
HIGH BAYS

HIB High Bays

- LED UFO style high bays
- Input voltage range: 100-277V AC 50/60Hz
- Constant current LED driver inbuilt
- Housing & heatsink: Graphene
- Diffuser: PC
- LED chips: 3030 LED
- Power factor: ≥ 0.95
- CRI: 70
- Flex & plug: 1500mm
- Ambient temperature: -20 to 50°C
- Not suitable for dimming
- Suitable for 2-way switching
- Suitable for use with 3 wire motion or Microwave sensors

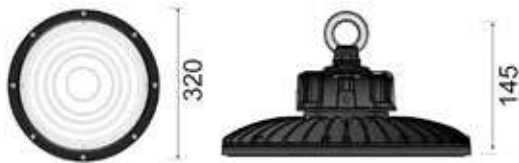

HIB12

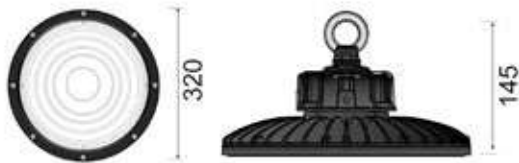

HIB13



Part No.	Description	Kelvin	Lumens	Watt	LEDs	CRI	Dimensions	Carton QTY
HIB12	HI BAY UFO LED 150W IP65 90D	5700K	18000LM	150W	180pcs 3030	70	Ø320X145mm	1/1
HIB13	HI BAY UFO LED 200W IP65 90D	5700K	24000LM	200W	240pcs 3030	70	Ø325X160mm	1/1



GENERAL LIGHTING
SECURITY LIGHTS



SEC Security Lights

- Surface mounted LED PAR30 security Lights with/ without sensor
- Adjustable: up/ down & side to side
- Input voltage: 240V AC
- Housing: PBT + PC
- Lamp holder: E27
- Max.150W PAR30 halogen globes
- 10W LED PAR30 globe (Part No. PAR3001) included

Sensor Spec:

- Detection range: 180°
- Detection distance: 5-12m
- Detection motion speed: 0.6-1.5m/s
- Rated load: 1200W (HAL) 300W (CFL & LED)
- Time delay: Min: 10s±3s; Max: 10m±3min
- Ambient light: 3-2000 lux (adj)
- Ambient temperature: -10 to 40°C
- Installation height: 1.8-2.5m
- Manual override via light switch

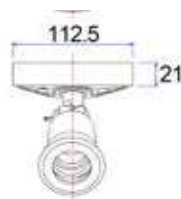

SEC01



SEC01S

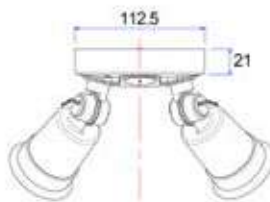

SEC02



SEC02S

Part No.	Description	PAR3001 INFO						Carton QTY
		Kelvin	Lumens	Watt	CRI	Beam	LEDs	
SEC01	SECURITY PAR30 ES S/ADJ BLK without sensor	5000K	800LM	10W	80	40°	10pcs 2835	1/40
SEC01S	SECURITY PAR30 ES S/ADJ BLK with sensor	5000K	800LM	10W	80	40°	10pcs 2835	1/32
SEC02	SECURITY PAR30 X 2 ES D/ADJ BLK without sensor	5000K	2x800LM	2x10W	80	40°	10pcs 2835	1/24
SEC02S	SECURITY PAR30 X 2 ES D/ADJ BLK with sensor	5000K	2x800LM	2x10W	80	40°	10pcs 2835	1/24

LED Globes Other Spec (Part No. PAR3001):

- LED chips: 10pcs SMD2835
- Power factor: ≥0.5
- Ambient temperature: -10 to 40°C
- Suitable for 2-way switching
- Suitable for use with PIR sensor



PAR3001

- Surface mounted LED security Lights with sensor
- Adjustable: head tilts down 90° and swivels 360°
- Input voltage range: 220-240V AC 50/60Hz
- Housing & diffuser: PC
- Mounting bracket: PC
- Heatsink: PC
- LED chips: 28pcs SMD2835
- CRI: >80
- Power factor: >0.9
- Ambient temperature: -20 to 40°C
- Suitable for 2-way switching

Sensor Spec:

- Sensor type: PIR
- Installation height: 1.8-2.5m
- Detection angle: 140°
- Motion detection distance: 9m Max
- Motion detection speed: 10 sec±3 sec to 5min±1min (Adjustable)
- UV resistant
- No manual override



SEC03S



SEC04S



Part No.	Description	Kelvin	Lumens	Watt	CRI	Beam	LEDs	Carton QTY
SEC03S	SECURITY FLOOD LED 15W S/ADJ WH with sensor	4000K	1100LM	15W	>80	120°	28pcs 2835	1/20
SEC04S	SECURITY FLOOD LED 15W S/ADJ BLK with sensor	4000K	1100LM	15W	>80	120°	28pcs 2835	1/20



GLOBES
LED GLOBES

SMTGU10 (5W) LED Globes

SMART LIGHTS

- GU10 LED smart Globe
- Input voltage range: 220–240V 50/60Hz
- Shade & diffuser: plastic
- LED chips: 20pcs SMD2835
- CRI: ≥80
- Power factor: 0.5
- Ambient temperature: -20 to 30°C
- App: control all functions via Tuya app on smart devices
- Manual: on/off control via normal wall switch
- Dimmable only via app or voice control through Amazon Alexa, Google Home and other compatible voice activated control devices (Not compatible with wall switch dimmer)
- Setup requires WiFi with Internet connection
- Suitable for 2-way switching
- Not suitable for use with sensors



Additional SMART Features:

- Tuneable RGB colour spectrum (up to 14 million colours)
- Tuneable colour temperature (3000K warm white through to 6500K daylight)
- Works with any 2.4GHz enabled WiFi network (note: will not currently pair with 5.0GHz bandwidth.) or Bluetooth LE 4.2
- Create schedules and timing to automate your home
- Control from anywhere via app or voice control using Alexa Hubs, Google Home and other compatible devices
- Compatible with all Tuya Powered apps

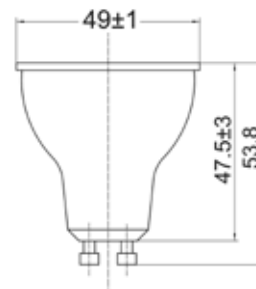

Scan QRCode to download

Part No.	Description	Base	Kelvin	Lumens	Watt	Dimensions	Carton QTY
SMTGU101	GLOBE LED SMART GU10 5W RGB TRI CCT	GU10	RGB+ 3000- 6000K	360-450LM- 3000K 400-500LM- 4000K 400-500LM-6000K	5W	Ø50X53.8mm	1/10/100

GU10TRI (6W) LED Globes



- GU10 LED Tri-CCT globe
- Input voltage: 176-264V AC
- Diffuser: plastic white
- Housing: plastic & aluminium
- Heatsink: PBT
- LED chips: 10pcs SMD2835
- Tri-CCT (3000K/ 4000K/ 5000K)
- CCT switch on housing
- CRI: ≥80
- Power factor: ≥0.5
- Ambient temperature: -20 to 40°C
- Not suitable for dimming
- Suitable for 2 way switching
- Suitable for use with sensors



Part No.	Description	Lumens			Watt	Size	Carton QTY
		3000K	4000K	5000K			
GU10TRI1	GLOBE LED GU10 6W TRI	432LM	495LM	605LM	6W	Ø50x60mm	1/10/100

GU10 LED Globes (6W)

- GU10 LED globes
- Input voltage range: 176-264V AC 50/60Hz
- Constant current LED driver inbuilt
- Housing: aluminium & Plastic
- LED chips: 9pcs SMD2835
- Power factor: >0.5
- Ambient temperature: -15 to 40°C
- Not suitable for dimming
- Suitable for 2 way switching
- Suitable for use with 3 wire PIR or microwave sensors



Part No.	Description	Base	Kelvin	Lumens	Watt	CRI	Dimensions	Carton QTY
GU1001	GLOBE LED GU10 6W 3000K FR 120D	GU10	3000K	470LM	6=40W	≥80	Ø50x52.8mm	1/10/100
GU1002	GLOBE LED GU10 6W 5000K FR 120D	GU10	5000K	485LM	6=40W	≥80	Ø50x52.8mm	1/10/100

GU10 Dimmable LED Globes (5W) LED Globes

- GU10 dimmable LED globes
- Input voltage range: 220-240V AC
- Inbuilt constant current LED driver
- Housing & diffuser: glass
- Power factor: >0.7
- LED chips: 6pcs SMD2835
- Ambient temperature: -20 to 50°C
- Suitable for dimming
- Suitable for 2-way switching
- Suitable for use with PIR sensor



Part No.	Description	Base	Kelvin	Lumens	Watt	CRI	Dimensions	Carton QTY
GU1003D	GLOBE LED GU10 DIMM 5W 3000K CLR	GU10	3000K	400LM	5W	>80	Ø50x56mm	1/10/100
GU1004D	GLOBE LED GU10 DIMM 5W 5000K CLR	GU10	5000K	400LM	5W	>80	Ø50x56mm	1/10/100

GU10 Coloured LED Globes (5W)

- GU10 coloured LED globe
- Input voltage range: 220-240V AC
- Inbuilt constant current LED driver
- Housing: plastic
- Power factor: 0.5
- LED chips: 10pcs SMD2835
- Ambient temperature: -10 to 40°C
- Suitable for 2-way switching
- Suitable for use with PIR sensor



Part No.	Description	Base	Kelvin	Lumens	Watt	CRI	Dimensions	Carton QTY
GU10B01A	GLOBE LED AC GU10 5W BLUE	GU10	BLUE	50LM	5=30W	N/A	Ø50x56mm	1/200
GU10G01A	GLOBE LED AC GU10 5W GREEN	GU10	GREEN	50LM	5=30W	N/A	Ø50x56mm	1/200
GU10R01A	GLOBE LED AC GU10 5W RED	GU10	RED	50LM	5=30W	N/A	Ø50x56mm	1/200

MR16TRI (6W)

LED Globes



- MR16 TRI-CCT LED globe
- Input voltage: 12V AC/DC
- Diffuser: plastic white
- Housing: plastic & aluminium
- Heatsink: PBT
- LED chips: 10pcs SMD2835
- Tri-CCT (3000K/ 4000K/ 5000K)
- CCT switch on housing
- CRI: ≥80
- Power factor: ≥0.5
- Ambient temperature: -20 to 40°C
- Not suitable for dimming
- Not suitable for 2 way switching
- Not suitable for use with sensors



Part No.	Description	Lumens			Watt	Size	Carton QTY
		3000K	4000K	5000K			
MR16TRI1	GLOBE LED MR16 6W TRI	432LM	495LM	605LM	6W	Ø50x56mm	1/10/100

MR16 LED Globes (6W)

- MR16 LED globes
- Input voltage: 12V AC/DC
- Driver input voltage: 12V 50/60Hz
- Housing & heat sink: aluminium & plastic
- LED chips: 6pcs SMD2835
- Power factor: ≥0.5
- CRI: 80
- Ambient temperature: -15 to 40°C
- Not suitable for dimming
- Suitable for 2 way switching
- Suitable for use with 3 wire PIR or Microwave sensors
- Remote constant voltage AC/DC control gear required

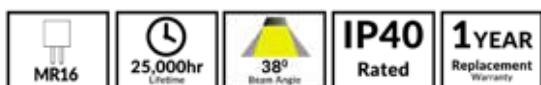

Part No.	Description	Base	Kelvin	Lumens	Watt	CRI	Dimensions	Carton
								QTY
MR1601A	GLOBE LED 12V AC/DC (Wh) MR16 3000K	MR16	3000K	480LM	6=40W	80	Ø50x47.7mm	1/10/100
MR1602A	GLOBE LED 12V AC/DC (Wh) MR16 5000K	MR16	5000K	495LM	6=40W	80	Ø50x47.7mm	1/10/100

*Tested & recommended control gears are listed next page.

MR16 LED Coloured Globes (5W) LED Globes

- MR16 coloured LED globes
- Input voltage: 12V AC/DC
- Housing: plastic & aluminium
- Wattage: 5W (=30W incandescent)
- Power factor: 0.8
- LED chips: 10pcs SMD2835 LED
- Ambient temperature: -10 to 40°C
- Not suitable for dimming
- Suitable for 2-way switching
- Suitable for use with PIR sensor
- Remote constant voltage AC/DC control gear required



Part No.	Description	Base	Kelvin	Lumens	Watt	CRI	Dimensions	Carton QTY
MR16B01A	GLOBE LED 12V AC/DC MR16 BLUE	MR16	BLUE	50LM	5=30W	N/A	Ø50x46mm	1/200
MR16G01A	GLOBE LED 12V AC/DC MR16 GREEN	MR16	GREEN	50LM	5=30W	N/A	Ø50x46mm	1/200
MR16R01A	GLOBE LED 12V AC/DC MR16 RED	MR16	RED	50LM	5=30W	N/A	Ø50x46mm	1/200

Tested & Recommended Control Gears for MR16 LED globes:

Brand	Part No.	Type	IP Rating
CLA	CLADR12W / CLADR12WFP	12W LED Driver (Constant Voltage)	IP20
CLA	DRIV1	12W LED Driver (Constant Voltage)	IP20
CLA	OTTER1	12W LED Driver (Constant Voltage)	IP67
CLA	CLA111011	10W LED Driver (Constant Voltage)	IP67
CLA	CLA113011	30W LED Driver (Constant Voltage)	IP67
CLA	CLA115011	50W LED Driver (Constant Voltage)	IP67
CLA	CLA1110011	100W LED Driver (Constant Voltage)	IP67
CLA	OTTER5	150W LED Driver (Constant Voltage)	IP67
CLA	CLA1120011	200W LED Driver (Constant Voltage)	IP67
CLA	OTTER7	300W LED Driver (Constant Voltage)	IP67
LUXMAN	ETH50.302VA	50W Transformer	IP65

MR11 LED Globes (4W) LED Globes

- MR11 LED globes
- Input voltage: 12V AC/DC
- Heatsink: aluminium
- Wattage: 4W=30W Incandescent globe
- LED chips: 3pcs SMD2835
- CRI: >80
- Power factor: ≥0.5
- Ambient temperature: -20 to 50°C
- Not suitable for dimming
- Suitable for 2 way switching
- Suitable for use with sensors
- Remote control gear required



Part No.	Description	Base	Kelvin	Lumens	Watt	Dimensions	Carton QTY
MR1101	GLOBE LED 12V GU4 AC/DC MR11 4W 3000K	GU4	3000K	260LM	4W	Ø34.8X38.5mm	1/10/100
MR1102	GLOBE LED 12V GU4 AC/DC MR11 4W 5000K	GU4	5000K	260LM	4W	Ø34.8X38.5mm	1/10/100

Tested & Recommended Control Gears for MR11 LED globes:

Brand	Part No.	Type	IP Rating
CLA	CLADR12W / CLADR12WFP	12W LED Driver (Constant Voltage)	IP20
CLA	DRIV1	12W LED Driver (Constant Voltage)	IP20
CLA	OTTER1	12W LED Driver (Constant Voltage)	IP67
CLA	CLA111011	10W LED Driver (Constant Voltage)	IP67
CLA	CLA113011	30W LED Driver (Constant Voltage)	IP67
CLA	CLA115011	50W LED Driver (Constant Voltage)	IP67
CLA	CLA1110011	100W LED Driver (Constant Voltage)	IP67
CLA	OTTER5	150W LED Driver (Constant Voltage)	IP67
CLA	CLA1120011	200W LED Driver (Constant Voltage)	IP67
CLA	OTTER7	300W LED Driver (Constant Voltage)	IP67
LUXMAN	ETH50.302VA	50W Transformer	IP65

- GLS LED smart Globe
- Input voltage range: 220-240V 50/60Hz
- Housing: plastic & aluminium
- Diffuser: plastic
- Frosted Diffuser
- LED chips: 20pcs SMD2835
- CRI: ≥ 80
- Power factor: ≥ 0.5
- Ambient temperature: -20 to 30°C
- App: control all functions via Tuya app on smart devices
- Manual: on/off control via normal wall switch
- Dimmable only via app or voice control through Amazon Alexa, Google Home and other compatible voice activated control devices (Not compatible with wall switch dimmer)
- Setup requires WiFi connection
- Suitable for 2-way switching
- Not suitable for use with sensor



Additional SMART Features:

- Tuneable RGB colour spectrum (up to 14 million colours)
- Tuneable colour temperature (3000K warm white through to 6500K daylight)
- Works with any 2.4GHz enabled WiFi network (note: will not currently pair with 5.0GHz bandwidth.) or Bluetooth LE 4.2
- Create schedules and timing to automate your home
- Control from anywhere via app or voice control using Alexa Hubs, Google Home and other compatible devices
- Compatible with all Tuya Powered apps

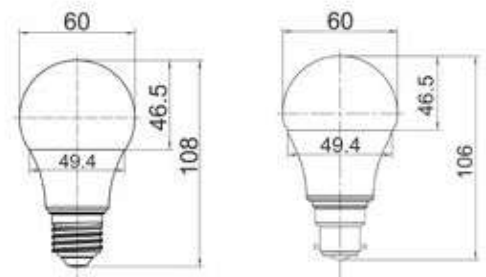

Tuya Smart
Formal version



Scan QRCode to download

Part No.	Description	Base	Kelvin	Lumens	Watt	Dimensions	Carton QTY
SMTGLS1	GLOBE LED SMART ES GLS 10W RGB TRI CCT	E27	RGB+ 3000- 6000K	700-800LM- 3000K 750-880LM- 4000K	10W	Ø60X108mm	1/10/100
SMTGLS2	GLOBE LED SMART BC GLS 10W RGB TRI CCT	B22	6000K	750-880LM-6000K	10W	Ø60X108mm	1/10/100

GLSTRI (10W) LED Globes



- Input voltage: 176-264V AC
- Diffuser: plastic frosted
- Housing: plastic & aluminium
- Heatsink: PBT
- LED chips: 16pcs SMD2835
- Tri-CCT (3000K/ 4000K/ 5000K)
- CCT switch on housing
- CRI: ≥80
- Power factor: ≥0.5
- Ambient temperature: -20 to 40°C
- Not suitable for dimming
- Suitable for 2 way switching
- Suitable for use with sensors

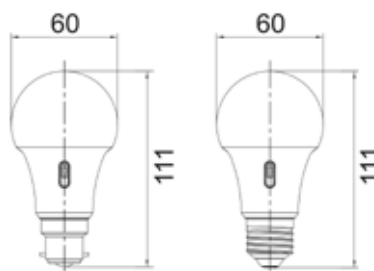

Part No.	Description	Base	Lumens			Watt	Dimensions	Carton QTY
			3000K	4000K	5000K			
GLSTRIBC1	GLOBE LED BC GLS 10W TRI	B22	729LM	792LM	891LM	10W	Ø60x111mm	1/10/50
GLSTRIES1	GLOBE LED ES GLS 10W TRI	E27	729LM	792LM	891LM	10W	Ø60x111mm	1/10/50

GLS LED Filament Globes (8W)

- LED filament GLS dimmable globes
- Input Voltage range: 180-260V AC 50/60Hz
- Diffuser: clear glass
- LED chips: 4x24pcs 5131JC
- Power factor: >0.7
- Ambient temperature: -20 to 50°C
- Suitable for dimming
- Suitable for 2-way switching
- Suitable for use with PIR or Microwave sensors



Tested & Recommended Dimmers:

Brand	Part No.
CLA	VELA
LEGRAND	Cat AR400A3PM
CLIPSAL	32ELEDM, 32E450TM, 31E2RUDM, 32E450UDM
DIGINET	MEDM

Part No.	Description	Base	Kelvin	Lumens	Watt	CRI	Dimensions	Carton QTY
CF14DIM	GLOBE LED CARBON LOOK DIMM BC GLS 8W	B22	2700K	800LM	8=75W	>80	Ø60x105mm	1/25/100
CF15DIM	GLOBE LED CARBON LOOK DIMM BC GLS 8W	B22	6000K	800LM	8=75W	>80	Ø60x105mm	1/25/100
CF16DIM	GLOBE LED CARBON LOOK DIMM ES GLS 8W	E27	2700K	800LM	8=75W	>80	Ø60x105mm	1/25/100
CF17DIM	GLOBE LED CARBON LOOK DIMM ES GLS 8W	E27	6000K	800LM	8=75W	>80	Ø60x105mm	1/25/100

- Input voltage: 180-260V
- Heatsink: aluminium
- Diffuser: frosted glass
- LED chips: 4x24pcs 5131JC
- Power factor: >0.7
- CRI: >80
- Ambient temp: -20 to 50°C
- Suitable for use with dimmers
- Suitable for 2-way switching
- Suitable for use with sensors



Tested & Recommended Dimmers:

Brand	Part No.
CLA	VELA
LEGRAND	Cat AR400A3PM
CLIPSAL	32ELEDM, 32E450TM, 31E2RUDM, 32E450UDM
DIGINET	MEDM

Part No.	Description	Base	Kelvin	Lumens	Watt	Dimensions	Carton QTY
GLS36D	GLOBE LED BC GLS 8W DIMM FR	B22	2700K	800LM	8W	Ø60x105mm	1/25/100
GLS37D	GLOBE LED ES GLS 8W DIMM FR	E27	2700K	800LM	8W	Ø60x105mm	1/25/100
GLS38D	GLOBE LED BC GLS 8W DIMM FR	B22	6000K	800LM	8W	Ø60x105mm	1/25/100
GLS39D	GLOBE LED ES GLS 8W DIMM FR	E27	6000K	800LM	8W	Ø60x105mm	1/25/100

GLS LED Globes (6-15W) LED Globes

- Input voltage range: 176-264V AC 50/60Hz
- Material: PBT, aluminium, plastic & PC
- Diffuser: frosted plastic
- LED chips: 2835 LED
- Power factor: ≥ 0.5
- Ambient temperature: -15 to 40°C
- Not suitable for dimming
- Suitable for 2 way switching
- Suitable for use with sensors



Part No.	Description	Base	Kelvin	Lumens	Watt	CRI	Dimensions	Carton QTY
6W								
GLS13B	GLOBE LED ES GLS 6W 3000K FR 180D	E27	3000K	470LM	6W	>80	Ø60x109mm	1/10/50
GLS14B	GLOBE LED ES GLS 6W 5000K FR 180D	E27	5000K	490LM	6W	>80	Ø60x109mm	1/10/50
GLS15B	GLOBE LED BC GLS 6W 3000K FR 180D	B22	3000K	470LM	6W	>80	Ø60x108mm	1/10/50
GLS16B	GLOBE LED BC GLS 6W 5000K FR 180D	B22	5000K	490LM	6W	>80	Ø60x108mm	1/10/50
10W								
GLS31	GLOBE LED BC GLS 10W 3000K FR 180D	B22	3000K	800LM	10W	>80	Ø60x108mm	1/10/50
GLS32	GLOBE LED BC GLS 10W 5000K FR 180D	B22	5000K	825LM	10W	>80	Ø60x108mm	1/10/50
GLS33	GLOBE LED ES GLS 10W 3000K FR 180D	E27	3000K	800LM	10W	>80	Ø60x109mm	1/10/50
GLS34	GLOBE LED ES GLS 10W 5000K FR 180D	E27	5000K	825LM	10W	>80	Ø60x109mm	1/10/50
13W								
GLS21B	GLOBE LED ES GLS 13W 3000K FR 180D	E27	3000K	1055LM	13W	>80	Ø60x117mm	1/10/50
GLS22B	GLOBE LED ES GLS 13W 5000K FR 180D	E27	5000K	1107LM	13W	>80	Ø60x117mm	1/10/50
GLS23B	GLOBE LED BC GLS 13W 3000K FR 180D	B22	3000K	1055LM	13W	>80	Ø60x117mm	1/10/50
GLS24B	GLOBE LED BC GLS 13W 5000K FR 180D	B22	5000K	1107LM	13W	>80	Ø60x117mm	1/10/50
15W								
GLS25B	GLOBE LED BC GLS 15W 3000K FR 180D	B22	3000K	1348LM	15W	>80	Ø60x117mm	1/10/50
GLS26B	GLOBE LED ES GLS 15W 3000K FR 180D	E27	3000K	1348LM	15W	>80	Ø60x117mm	1/10/50
GLS27B	GLOBE LED BC GLS 15W 5000K FR 180D	B22	5000K	1470LM	15W	>80	Ø60x117mm	1/10/50
GLS28B	GLOBE LED ES GLS 15W 5000K FR 180D	E27	5000K	1470LM	15W	>80	Ø60x117mm	1/10/50

GLS LED Dimmable Globes (10W)

- Input voltage range: 176–264V AC 50/60Hz
- Constant current LED driver inbuilt
- Heat sink: aluminium-plastic
- Diffuser: frosted plastic
- LED chips: SMD2835 LED
- Power factor: ≥ 0.7
- Ambient temperature: -15 to 40°C
- Dimmable with most trailing edge or leading edge dimmers
- Suitable for 2-way switching
- Suitable for use with sensors

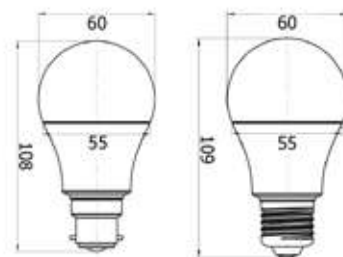

Tested & Recommended Dimmers:

Brand	Part No.
CLIPSAL	32E450UDM
CLIPSAL	32E350UDM
HPM Legrand	CAT400T

Part No.	Description	Base	Kelvin	Lumens	Watt	CRI	Dimensions	Carton QTY
GLS9DB	GLOBE LED BC GLS DIMM 10W 3000K FR	B22	3000K	810LM	10W	>80	Ø60x108mm	1/10/50
GLS10DB	GLOBE LED ES GLS DIMM 10W 3000K FR	E27	3000K	810LM	10W	>80	Ø60x109mm	1/10/50
GLS11DB	GLOBE LED BC GLS DIMM 10W 5000K FR	B22	5000K	850LM	10W	>80	Ø60x108mm	1/10/50
GLS12DB	GLOBE LED ES GLS DIMM 10W 5000K FR	E27	5000K	850LM	10W	>80	Ø60x109mm	1/10/50
GLS29D	GLOBE LED BC GLS DIMM 10W 4000K FR	B22	4000K	810LM	10W	>80	Ø60x108mm	1/10/50
GLS30D	GLOBE LED ES GLS DIMM 10W 4000K FR	E27	4000K	810LM	10W	>80	Ø60x109mm	1/10/50

Fancy Round LED Filament Globes (4W) LED Globes

- LED filament G45 dimmable globes
- Input Voltage range: 180–260V AC 50/60Hz
- Diffuser: clear glass
- LED chips: 4x24pcs 5131JC
- Power factor: >0.7
- Ambient temperature: -20 to 50°C
- Suitable for use with dimmers
- Suitable for 2-way switching
- Suitable for use with PIR or Microwave sensors



Tested & Recommended Dimmers:

Brand	Part No.
CLA	VELA
LEGRAND	Cat AR400A3PM
CLIPSAL	32ELEDM, 32E450TM, 31E2RUDM, 32E450UDM
DIGINET	MEDM

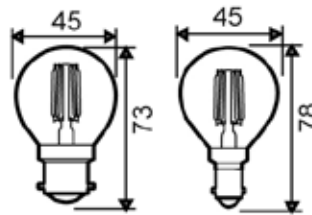

Part No.	Description	Base	Kelvin	Lumens	Watt	CRI	Dimensions	Carton QTY
CF30DIM	GLOBE LED CARBON LOOK BC G45 4W	B22	2700K	400LM	4=40W	>80	Ø45x73mm	1/25/100
CF31DIM	GLOBE LED CARBON LOOK BC G45 4W	B22	6000K	400LM	4=40W	>80	Ø45x73mm	1/25/100
CF32DIM	GLOBE LED CARBON LOOK E27 G45 4W	E27	2700K	400LM	4=40W	>80	Ø45x73mm	1/25/100
CF33DIM	GLOBE LED CARBON LOOK E27 G45 4W	E27	6000K	400LM	4=40W	>80	Ø45x73mm	1/25/100
CF34DIM	GLOBE LED CARBON LOOK SBC G45 4W	B15	2700K	400LM	4=40W	>80	Ø45x78mm	1/25/100
CF35DIM	GLOBE LED CARBON LOOK SBC G45 4W	B15	6000K	400LM	4=40W	>80	Ø45x78mm	1/25/100
CF36DIM	GLOBE LED CARBON LOOK SES G45 4W	E14	2700K	400LM	4=40W	>80	Ø45x78mm	1/25/100
CF37DIM	GLOBE LED CARBON LOOK SES G45 4W	E14	6000K	400LM	4=40W	>80	Ø45x78mm	1/25/100

- Input voltage: 180–260V
- Heatsink: aluminium
- Diffuser: frosted glass
- LED chips: 4x24pcs 5131JC
- Power factor: >0.7
- CRI: >80
- Ambient temp: -20 to 50°C
- Suitable for use with dimmers
- Suitable for 2-way switching
- Suitable for use with sensors



Tested & Recommended Dimmers:

Brand	Part No.
CLA	VELA
LEGRAND	Cat AR400A3PM
CLIPSAL	32ELEDM, 32E450TM, 31E2RUDM, 32E450UDM
DIGINET	MEDM

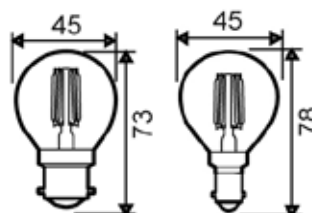

Part No.	Description	Base	Kelvin	Lumens	Watt	CRI	Dimensions	Carton QTY
FR41D	GLOBE LED DIMM filament 4W F/RND	B22	2700K	400LM	4W	>80	Ø45x73mm	1/25/100
FR42D	GLOBE LED DIMM filament 4W F/RND	B22	6000K	400LM	4W	>80	Ø45x73mm	1/25/100
FR43D	GLOBE LED DIMM filament 4W F/RND	E27	2700K	400LM	4W	>80	Ø45x73mm	1/25/100
FR44D	GLOBE LED DIMM filament 4W F/RND	E27	6000K	400LM	4W	>80	Ø45x73mm	1/25/100
FR45D	GLOBE LED DIMM filament 4W F/RND	B15	2700K	400LM	4W	>80	Ø45x78mm	1/25/100
FR46D	GLOBE LED DIMM filament 4W F/RND	B15	6000K	400LM	4W	>80	Ø45x78mm	1/25/100
FR47D	GLOBE LED DIMM filament 4W F/RND	E14	2700K	400LM	4W	>80	Ø45x78mm	1/25/100
FR48D	GLOBE LED DIMM filament 4W F/RND	E14	6000K	400LM	4W	>80	Ø45x78mm	1/25/100

Fancy Round LED Globes (3W) LED Globes

- Input voltage: 240V AC 50/60Hz
- Heatsink: aluminium
- Housing: aluminium-plastic & PC
- Diffuser: frosted
- LED chips: 6pcs SMD2835 LED
- Power factor: ≥ 0.4
- Ambient temperature: -15 to 40°C
- Not suitable for dimming
- Suitable for 2 way switching
- Suitable for use with PIR or Microwave sensors

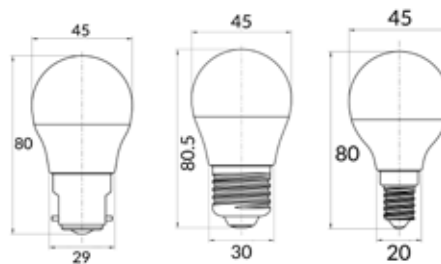

Part No.	Description	Base	Kelvin	Lumens	Watt	CRI	Dimensions	Carton QTY
FR36	GLOBE LED SES F/RND 3W 3000K FR 180D	E14	3000K	235LM	3=25W	80	Ø45x80mm	1/10/100
FR37	GLOBE LED BC F/RND 3W 5000K FR 180D	B22	5000K	260LM	3=25W	80	Ø45x80mm	1/10/100
FR40	GLOBE LED SES 3W F/RND 5000K FR 180D	E14	5000K	260LM	3=25W	80	Ø45x80mm	1/10/100

Fancy Round LED Globes (4W) LED Globes

- Input voltage range: 220-240V AC 50/60Hz
- Cap base: aluminium
- Heat sink: aluminium
- Diffuser: clear glass
- LED chips: 34pcs 3014 LED
- Power factor: ≥ 0.4
- Ambient temperature: -20 to 50°C
- Not suitable for dimming
- Suitable for use with sensors

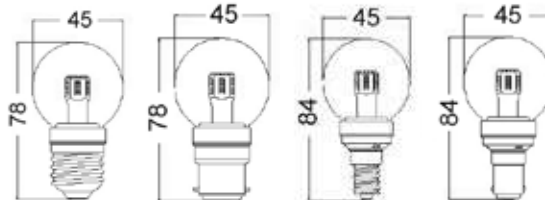

Part No.	Description	Base	Kelvin	Lumens	Watt	CRI	Dimensions	Carton QTY
FR1	GLOBE LED ES F/RND 4W 3000K CLR 300D	E27	3000K	260LM	4=25W	80	Ø45x78mm	1/10/100
FR3	GLOBE LED SES F/RND 4W 3000K CLR 300D	E14	3000K	295LM	4=25W	80	Ø45x84mm	1/10/100
FR4	GLOBE LED SBC F/RND 4W 3000K CLR 300D	B15	3000K	260LM	4=25W	80	Ø45x84mm	1/10/100
FR5	GLOBE LED ES F/RND 4W 5000K CLR 300D	E27	5000K	290LM	4=25W	80	Ø45x78mm	1/10/100
FR6	GLOBE LED BC F/RND 4W 5000K CLR 300D	B22	5000K	290LM	4=25W	80	Ø45x78mm	1/10/100
FR7	GLOBE LED SES F/RND 4W 5000K CLR 300D	E14	5000K	320LM	4=25W	80	Ø45x84mm	1/10/100
FR8	GLOBE LED SBC F/RND 4W 5000K CLR 300D	B15	5000K	320LM	4=25W	80	Ø45x84mm	1/10/100

- Input voltage range: 220-240V AC 50/60Hz
- Cap base: aluminium
- Heat sink: aluminium
- Diffuser: frosted glass
- LED chips: 34pcs 3014 LED
- Power factor: ≥ 0.4
- Ambient temperature: -20 to 50°C
- Not suitable for dimming
- Suitable for use with sensors

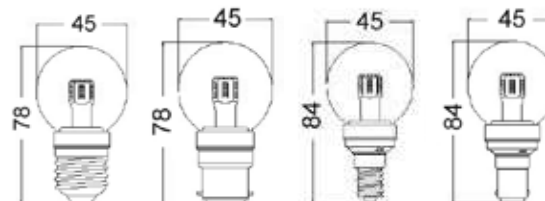

Part No.	Description	Base	Kelvin	Lumens	Watt	CRI	Dimensions	Carton QTY
FR10	GLOBE LED BC F/RND 4W 3000K FR 300D	B22	3000K	280LM	4=25W	80	Ø45x78mm	1/10/100
FR11	GLOBE LED SES F/RND 4W 3000K FR 300D	E14	3000K	280LM	4=25W	80	Ø45x84mm	1/10/100
FR12	GLOBE LED SBC F/RND 4W 3000K FR 300D	B15	3000K	280LM	4=25W	80	Ø45x84mm	1/10/100
FR13	GLOBE LED ES F/RND 4W 5000K FR 300D	E27	5000K	300LM	4=25W	80	Ø45x78mm	1/10/100
FR15	GLOBE LED SES F/RND 4W 5000K FR 300D	E14	5000K	300LM	4=25W	80	Ø45x84mm	1/10/100
FR16	GLOBE LED SBC F/RND 4W 5000K FR 300D	B15	5000K	300LM	4=25W	80	Ø45x84mm	1/10/100

Candle LED Filament Globes (4W) LED Globes

- Input Voltage range: 180-260V AC 50/60Hz
- Diffuser: clear glass
- LED chips: 4x24pcs 5131JC
- Power factor: >0.7
- Ambient temperature: -20 to 50°C
- Suitable for dimming
- Suitable for 2-way switching
- Suitable for use with PIR or Microwave sensors

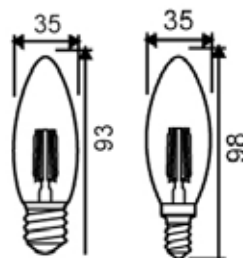

Tested & Recommended Dimmers:

Brand	Part No.
CLA	VELA
LEGRAND	Cat AR400A3PM
CLIPSAL	32ELEDM, 32E450TM, 31E2RUDM, 32E450UDM
DIGINET	MEDM

Part No.	Description	Base	Kelvin	Lumens	Watt	CRI	Dimensions	Carton QTY
CF38DIM	GLOBE LED CARBON LOOK BC C37 4W	B22	2700K	400LM	4=40W	>80	Ø35x93mm	1/25/100
CF39DIM	GLOBE LED CARBON LOOK BC C37 4W	B22	6000K	400LM	4=40W	>80	Ø35x93mm	1/25/100
CF40DIM	GLOBE LED CARBON LOOK ES C37 4W	E27	2700K	400LM	4=40W	>80	Ø35x93mm	1/25/100
CF41DIM	GLOBE LED CARBON LOOK ES C37 4W	E27	6000K	400LM	4=40W	>80	Ø35x93mm	1/25/100
CF42DIM	GLOBE LED CARBON LOOK SBC C37 4W	B15	2700K	400LM	4=40W	>80	Ø35x98mm	1/25/100
CF43DIM	GLOBE LED CARBON LOOK SBC C37 4W	B15	6000K	400LM	4=40W	>80	Ø35x98mm	1/25/100
CF44DIM	GLOBE LED CARBON LOOK SES C37 4W	E14	2700K	400LM	4=40W	>80	Ø35x98mm	1/25/100
CF45DIM	GLOBE LED CARBON LOOK SES C37 4W	E14	6000K	400LM	4=40W	>80	Ø35x98mm	1/25/100

- Input Voltage range: 180-260V AC 50/60Hz
- Diffuser: frosted glass
- LED chips: 4x24pcs 5131JC
- Power factor: >0.7
- Ambient temperature: -20 to 50°C
- Suitable for dimming
- Suitable for 2-way switching
- Suitable for use with PIR or Microwave sensors

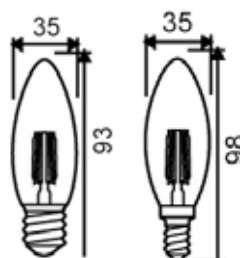

Tested & Recommended Dimmers:

Brand	Part No.
CLA	VELA
LEGRAND	Cat AR400A3PM
CLIPSAL	32ELEDM, 32E450TM, 31E2RUDM, 32E450UDM
DIGINET	MEDM

Part No.	Description	Base	Kelvin	Lumens	Watt	CRI	Dimensions	Carton QTY
CAN33D	GLOBE LED DIMM filament 4W candle	B22	2700K	400LM	4W	>80	Ø35x93mm	1/25/100
CAN34D	GLOBE LED DIMM filament 4W candle	B22	6000K	400LM	4W	>80	Ø35x93mm	1/25/100
CAN35D	GLOBE LED DIMM filament 4W candle	E27	2700K	400LM	4W	>80	Ø35x93mm	1/25/100
CAN36D	GLOBE LED DIMM filament 4W candle	E27	6000K	400LM	4W	>80	Ø35x93mm	1/25/100
CAN37D	GLOBE LED DIMM filament 4W candle	B15	2700K	400LM	4W	>80	Ø35x98mm	1/25/100
CAN38D	GLOBE LED DIMM filament 4W candle	B15	6000K	400LM	4W	>80	Ø35x98mm	1/25/100
CAN39D	GLOBE LED DIMM filament 4W candle	E14	2700K	400LM	4W	>80	Ø35x98mm	1/25/100
CAN40D	GLOBE LED DIMM filament 4W candle	E14	6000K	400LM	4W	>80	Ø35x98mm	1/25/100

Candle LED Globes (3W) LED Globes

- Input voltage range: 176–264V AC 50/60Hz
- Housing: aluminium-plastic & PC
- Diffuser: frosted
- Heat sink: aluminium
- Life time: A series: 20,000hrs (others: 30,000hrs)
- Power factor: >0.5
- Ambient temperature: -15 to 40°C
- Not suitable for dimming



Part No.	Description	Base	Kelvin	Lumens	Watt	CRI	Dimensions	Carton QTY
CAN17	GLOBE LED SBC CAN 3W 5000K FR	B15	5000K	260LM	3=25W	≥80	Ø36x102mm	1/10/100
CAN18	GLOBE LED BC CAN 3W 5000K FR	B22	5000K	260LM	3=25W	≥80	Ø36x100mm	1/10/100
CAN20	GLOBE LED ES CAN 3W 5000K FR	E27	5000K	260LM	3=25W	≥80	Ø36x100mm	1/10/100
CAN24	GLOBE LED ES CAN 3W 3000K FR	E27	3000K	250LM	3=25W	≥80	Ø36x100mm	1/10/100

Candle LED Globes (4W) LED Globes

- Input voltage range: 220-264V AC 50/60Hz
- LED chips: 13pcs 2835
- Power factor: ≥ 0.4
- Housing & heat sink: aluminium
- Diffuser: clear glass
- Ambient temperature: -15 to 40°C
- Not suitable for dimming
- Suitable for use with sensor

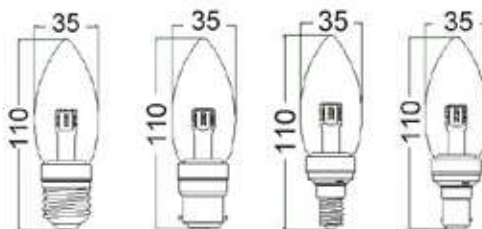

Part No.	Description	Base	Kelvin	Lumens	Watt	CRI	Dimensions	Carton QTY
CAN4	GLOBE LED SBC CAN 4W 3000K CLR	B15	3000K	390LM	4=25W	80	Ø35x110mm	1/10/100
CAN5	GLOBE LED ES CAN 4W 5000K CLR	E27	5000K	420LM	4=25W	80	Ø35x110mm	1/10/100
CAN6	GLOBE LED BC CAN 4W 5000K CLR	B22	5000K	420LM	4=25W	80	Ø35x110mm	1/10/100
CAN8	GLOBE LED SBC CAN 4W 5000K CLR	B15	5000K	420LM	4=25W	80	Ø35x110mm	1/10/100

- Input voltage range: 220-264V AC 50/60Hz
- LED chips: 13pcs 2835
- Power factor: ≥ 0.4
- Housing & heat sink: aluminium
- Diffuser: frosted glass
- Ambient temperature: -15 to 40°C
- Not suitable for dimming
- Suitable for use with sensor

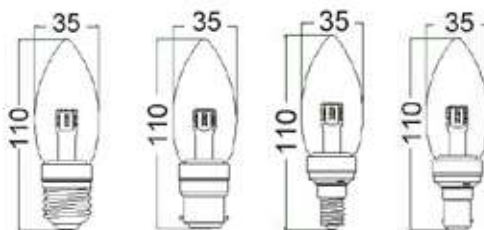

Part No.	Description	Base	Kelvin	Lumens	Watt	CRI	Dimensions	Carton QTY
CAN9	GLOBE LED ES CAN 4W 3000K FR	E27	3000K	345LM	4=25W	80	Ø35x110mm	1/10/100
CAN10	GLOBE LED BC CAN 4W 3000K FR	B22	3000K	345LM	4=25W	80	Ø35x110mm	1/10/100
CAN13	GLOBE LED ES CAN 4W 5000K FR	E27	5000K	370LM	4=25W	80	Ø35x110mm	1/10/100
CAN16	GLOBE LED SBC CAN 4W 5000K FR	B15	5000K	370LM	4=25W	80	Ø35x110mm	1/10/100

Candle LED Globes (6W) LED Globes

- Input voltage range: 176–264V AC 50/60Hz
- Housing: aluminium–plastic & PC
- Diffuser: frosted
- Heat sink: aluminium
- Power factor: >0.5
- Ambient temperature: –15 to 40°C
- Not suitable for dimming



Part No.	Description	Base	Kelvin	Lumens	Watt	CRI	Dimensions	Carton QTY
CAN25	GLOBE LED ES CAN 6W 3000K FR	E27	3000K	470LM	6=40W	≥80	Ø38x102mm	1/10/100
CAN28A	GLOBE LED SBC CAN 6W 3000K FR	B15	3000K	470LM	6=40W	≥80	Ø36x97.5mm	1/10/100
CAN29	GLOBE LED ES CAN 6W 5000K FR	E27	5000K	490LM	6=40W	≥80	Ø38x102mm	1/10/100
CAN32A	GLOBE LED SBC CAN 6W 5000K FR	B15	5000K	490LM	6=40W	≥80	Ø38x107mm	1/10/100

Candle LED Dimmable Globes (4W)

- Input voltage range: 220–264V AC 50/60Hz
- LED chips: 18pcs EDISON 3014 LED
- Power factor: ≥0.8
- Housing & heat sink: aluminium
- Diffuser: clear glass
- Ambient temperature: –15 to 40°C
- Suitable for dimming
- Recommended trailing edge dimmers
- Suitable for use with sensors



Tested & Recommended Dimmers:

Brand	Part No.
HPM	CAT400T
CLIPSAL	450TM, 32E450UDM, 31E2RUDM 350
Luxman	T400PCFL



Part No.	Description	Base	Kelvin	Lumens	Watt	CRI	Dimensions	Carton QTY
CAN1D	GLOBE LED ES CAN 4W 3000K CLR	E27	3000K	360LM	4=25W	80	Ø35x115mm	1/10/100
CAN2D	GLOBE LED BC CAN 4W 3000K CLR	B22	3000K	360LM	4=25W	80	Ø35x113mm	1/10/100
CAN3D	GLOBE LED SES CAN 4W 3000K CLR	E14	3000K	360LM	4=25W	80	Ø35x125mm	1/10/100
CAN4D	GLOBE LED SBC CAN 4W 3000K CLR	B15	3000K	360LM	4=25W	80	Ø35x124mm	1/10/100
CAN5D	GLOBE LED ES CAN 4W 5000K CLR	E27	5000K	370LM	4=25W	80	Ø35x115mm	1/10/100
CAN6D	GLOBE LED BC CAN 4W 5000K CLR	B22	5000K	370LM	4=25W	80	Ø35x113mm	1/10/100
CAN7D	GLOBE LED SES CAN 4W 5000K CLR	E14	5000K	370LM	4=25W	80	Ø35x125mm	1/10/100
CAN8D	GLOBE LED SBC CAN 4W 5000K CLR	B15	5000K	370LM	4=25W	80	Ø35x124mm	1/10/100

- Input voltage range: 220-264V AC 50/60Hz
- LED chips: 18pcs EDISON 3014 LED
- Power factor: ≥0.8
- Housing & heat sink: aluminium
- Diffuser: frosted glass
- Ambient temperature: -15 to 40°C
- Suitable for dimming
- Recommended trailing edge dimmers
- Suitable for use with sensors



Tested & Recommended Dimmers:

Brand	Part No.
HPM	CAT400T
CLIPSAL	450TM, 32E450UDM, 31E2RUDM 350
Luxman	T400PCFL

Part No.	Description	Base	Kelvin	Lumens	Watt	CRI	Dimensions	Carton QTY
CAN9D	GLOBE LED ES CAN 4W 3000K FR	E27	3000K	340LM	4=25W	80	Ø35x115mm	1/10/100
CAN10D	GLOBE LED BC CAN 4W 3000K FR	B22	3000K	340LM	4=25W	80	Ø35x113mm	1/10/100
CAN11D	GLOBE LED SES CAN 4W 3000K FR	E14	3000K	340LM	4=25W	80	Ø35x125mm	1/10/100
CAN13D	GLOBE LED ES CAN 4W 5000K FR	E27	5000K	350LM	4=25W	80	Ø35x115mm	1/10/100
CAN14D	GLOBE LED BC CAN 4W 5000K FR	B22	5000K	350LM	4=25W	80	Ø35x113mm	1/10/100
CAN15D	GLOBE LED SES CAN 4W 5000K FR	E14	5000K	350LM	4=25W	80	Ø35x125mm	1/10/100
CAN16D	GLOBE LED SBC CAN 4W 5000K FR	B15	5000K	350LM	4=25W	80	Ø35x124mm	1/10/100

T40 LED Globes (9W) LED Globes

- Input voltage range: 220-240V AC 50/60Hz
- Constant current LED driver inbuilt
- Housing: aluminium-plastic
- Heat sink: aluminium
- LED chips: 10pcs SMD2835 LED
- Power factor: >0.5
- Ambient temperature: -25 to 40°C
- Not suitable for dimming
- Suitable for 2-way switching
- Suitable for use with Microwave and PIR sensors

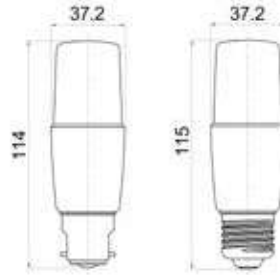

Part No.	Description	Base	Kelvin	Lumens	Watt	CRI	Dimensions	Carton QTY
LT4010	GLOBE LED BC T40 9W 3000K FR	B22	3000K	800LM	9W	≥80	Ø37.2x114mm	1/10/100
LT4011	GLOBE LED BC T40 9W 4000K FR	B22	4000K	800LM	9W	≥80	Ø37.2x114mm	1/10/100
LT4012	GLOBE LED BC T40 9W 5000K FR	B22	5000K	800LM	9W	≥80	Ø37.2x114mm	1/10/100
LT4013	GLOBE LED BC T40 9W 6000K FR	B22	6000K	800LM	9W	≥80	Ø37.2x114mm	1/10/100
LT4014	GLOBE LED ES T40 9W 3000K FR	E27	3000K	800LM	9W	≥80	Ø37.2x115mm	1/10/100
LT4015	GLOBE LED ES T40 9W 4000K FR	E27	4000K	800LM	9W	≥80	Ø37.2x115mm	1/10/100
LT4016	GLOBE LED ES T40 9W 5000K FR	E27	5000K	800LM	9W	≥80	Ø37.2x115mm	1/10/100
LT4017	GLOBE LED ES T40 9W 6000K FR	E27	6000K	800LM	9W	≥80	Ø37.2x115mm	1/10/100

T40 LED Dimmable Globes (9W)

- Input voltage range: 220-240V AC 50/60Hz
- Constant current LED driver inbuilt
- Housing: aluminium-plastic
- Heat sink: aluminium
- LED chips: 10pcs SMD2835 LED
- Power factor: >0.7
- Ambient temperature: -25 to 40°C
- Suitable for dimming
- Suitable for 2-way switching
- Suitable for use with Microwave and PIR sensors

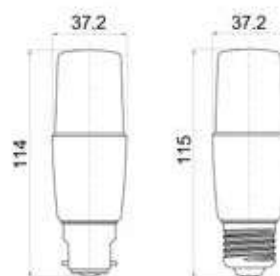

Tested & Recommended Dimmers:

Brand	Part No.
PDL	654M, 654TM
Legrand	CAT 400T
Diginet - LED smart	MEDM
Clipsal	32E450UDM, 32E450LM, 32ELEDM

Part No.	Description	Base	Kelvin	Lumens	Watt	CRI	Dimensions	Carton QTY
LT40D01	GLOBE LED BC T40 9W 3000K FR DIMM	B22	3000K	800LM	9W	≥80	Ø37.2x114mm	1/10/100
LT40D02	GLOBE LED BC T40 9W 4000K FR DIMM	B22	4000K	800LM	9W	≥80	Ø37.2x114mm	1/10/100
LT40D03	GLOBE LED BC T40 9W 5000K FR DIMM	B22	5000K	800LM	9W	≥80	Ø37.2x114mm	1/10/100
LT40D04	GLOBE LED BC T40 9W 6000K FR DIMM	B22	6000K	800LM	9W	≥80	Ø37.2x114mm	1/10/100
LT40D05	GLOBE LED ES T40 9W 3000K FR DIMM	E27	3000K	800LM	9W	≥80	Ø37.2x115mm	1/10/100
LT40D07	GLOBE LED ES T40 9W 5000K FR DIMM	E27	5000K	800LM	9W	≥80	Ø37.2x115mm	1/10/100
LT40D08	GLOBE LED ES T40 9W 6000K FR DIMM	E27	6000K	800LM	9W	≥80	Ø37.2x115mm	1/10/100

G95 LED Filament Globes (6W) LED Globes

- LED filament G95 dimmable globes
- Input Voltage range: 180-260V AC 50/60Hz
- Diffuser: clear glass
- LED chips: 4x24pcs 5131JC
- Power factor: >0.7
- Ambient temperature: -20 to 50°C
- Suitable for dimming
- Suitable for 2-way switching
- Suitable for use with PIR or Microwave sensors



Tested & Recommended Dimmers:

Brand	Part No.
CLA	VELA
LEGRAND	Cat AR400A3PM
CLIPSAL	32ELEDM, 32E450TM, 31E2RUDM, 32E450UDM
DIGINET	MEDM

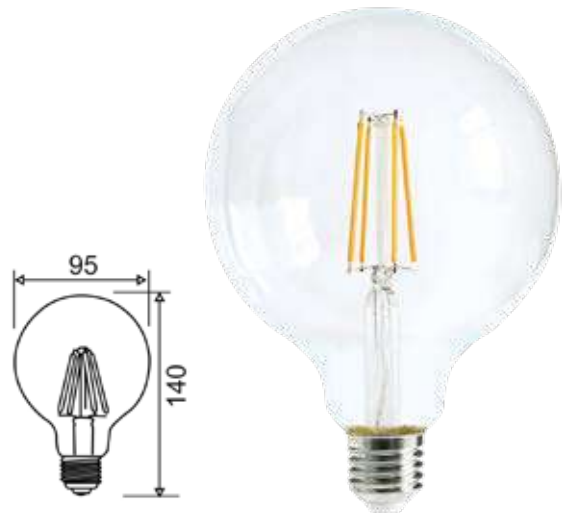

Part No.	Description	Base	Kelvin	Lumens	Watt	CRI	Dimensions	Carton QTY
CF18DIM	GLOBE LED CARBON LOOK BC G95 6W	B22	2700K	600LM	6=60W	>80	Ø95x140mm	1/50
CF19DIM	GLOBE LED CARBON LOOK BC G95 6W	B22	6000K	600LM	6=60W	>80	Ø95x140mm	1/50
CF20DIM	GLOBE LED CARBON LOOK E27 G95 6W	E27	2700K	600LM	6=60W	>80	Ø95x140mm	1/50
CF21DIM	GLOBE LED CARBON LOOK E27 G95 6W	E27	6000K	600LM	6=60W	>80	Ø95x140mm	1/50

- LED filament G95 dimmable globes
- Input Voltage range: 180-260V AC 50/60Hz
- Diffuser: frosted glass
- LED chips: 4x24pcs 5131JC
- Power factor: >0.7
- Ambient temperature: -20 to 50°C
- Suitable for dimming
- Suitable for 2-way switching
- Suitable for use with PIR or Microwave sensors



Tested & Recommended Dimmers:

Brand	Part No.
CLA	VELA
LEGRAND	Cat AR400A3PM
CLIPSAL	32ELEDM, 32E450TM, 31E2RUDM, 32E450UDM
DIGINET	MEDM

Part No.	Description	Base	Kelvin	Lumens	Watt	CRI	Dimensions	Carton QTY
G959	GLOBE LED BC G95 6W FR DIMM	B22	2700K	600LM	6W	>80	Ø95x140mm	1/25/50
G9510	GLOBE LED ES G95 6W FR DIMM	E27	2700K	600LM	6W	>80	Ø95x140mm	1/25/50
G9511	GLOBE LED BC G95 6W FR DIMM	B22	6000K	600LM	6W	>80	Ø95x140mm	1/25/50
G9512	GLOBE LED ES G95 6W FR DIMM	E27	6000K	600LM	6W	>80	Ø95x140mm	1/25/50

G95 LED Globes (6W) LED Globes

- Input voltage range: 90-264V AC 50/60Hz
- Housing & heat sink: aluminium
- Diffuser: clear glass
- LED chips: 21pcs 2835
- Power factor: ≥0.5
- Ambient temperature: -15 to 40°C
- Not suitable for dimming
- Suitable for use with sensors



Part No.	Description	Base	Kelvin	Lumens	Watt	CRI	Dimensions	Carton QTY
G953	GLOBE LED BC G95 6W CLR 5000K 300D	B22	5000K	650LM	6=40W	80	Ø95x152mm	1/40
G954	GLOBE LED ES G95 6W CLR 5000K 300D	E27	5000K	650LM	6=40W	80	Ø95x152mm	1/40

- Input voltage range: 90–264V AC 50/60Hz
- Housing & heat sink: aluminium
- Diffuser: frosted glass
- LED chips: 21pcs 2835
- Power factor: ≥0.5
- Ambient temperature: –15 to 40°C
- Not suitable for dimming
- Suitable for use with sensors



Part No.	Description	Base	Kelvin	Lumens	Watt	CRI	Dimensions	Carton QTY
G956	GLOBE LED ES G95 6W FR 3000K 300D	E27	3000K	590LM	6=40W	80	Ø95x152mm	1/40
G957	GLOBE LED BC G95 6W FR 5000K 300D	B22	5000K	620LM	6=40W	80	Ø95x152mm	1/40
G958	GLOBE LED ES G95 6W FR 5000K 300D	E27	5000K	620LM	6=40W	80	Ø95x152mm	1/40

G125 LED Filament Globes (8W) LED Globes

- LED filament G125 dimmable globes
- Input Voltage range: 180–260V AC 50/60Hz
- Diffuser: clear glass
- LED chips: 4x24pcs 5131JC
- Power factor: >0.7
- Ambient temperature: –20 to 50°C
- Suitable for dimming
- Suitable for 2-way switching
- Suitable for use with PIR or Microwave sensors

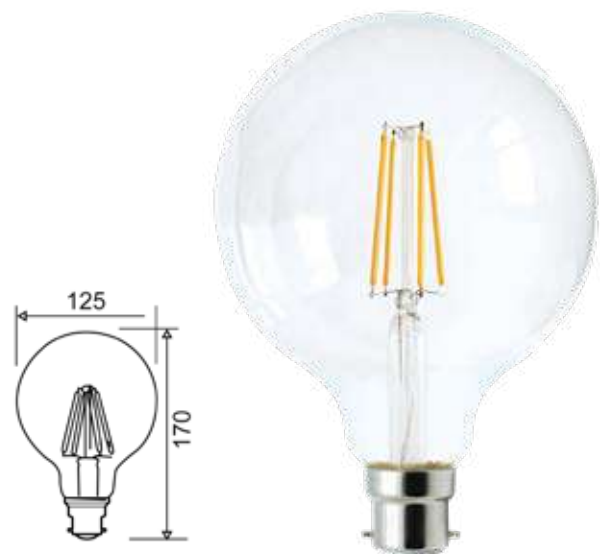

Tested & Recommended Dimmers:

Brand	Part No.
CLA	VELA
LEGRAND	Cat AR400A3PM
CLIPSAL	32ELEDM, 32E450TM, 31E2RUDM, 32E450UDM
DIGINET	MEDM

Part No.	Description	Base	Kelvin	Lumens	Watt	CRI	Dimensions	Carton QTY
CF22DIM	GLOBE LED CARBON LOOK BC G125 8W	B22	2700K	800LM	8=75W	>80	Ø125x170mm	1/50
CF23DIM	GLOBE LED CARBON LOOK BC G125 8W	B22	6000K	800LM	8=75W	>80	Ø125x170mm	1/50
CF24DIM	GLOBE LED CARBON LOOK ES G125 8W	E27	2700K	800LM	8=75W	>80	Ø125x170mm	1/50
CF25DIM	GLOBE LED CARBON LOOK ES G125 8W	E27	6000K	800LM	8=75W	>80	Ø125x170mm	1/50

- LED filament G125 dimmable globes
- Input Voltage range: 180-260V AC 50/60Hz
- Diffuser: frosted glass
- LED chips: 4x24pcs 5131JC
- Power factor: >0.7
- Ambient temperature: -20 to 50°C
- Suitable for dimming
- Suitable for 2-way switching
- Suitable for use with PIR or Microwave sensors



Tested & Recommended Dimmers:

Brand	Part No.
CLA	VELA
LEGRAND	Cat AR400A3PM
CLIPSAL	32ELEDM, 32E450TM, 31E2RUDM, 32E450UDM
DIGINET	MEDM

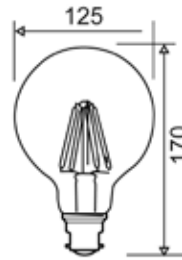

Part No.	Description	Base	Kelvin	Lumens	Watt	CRI	Dimensions	Carton QTY
G1259	GLOBE LED BC G125 8W FR DIMM	B22	2700K	800LM	8W	>80	Ø125x175mm	1/25/50
G12510	GLOBE LED ES G125 8W FR DIMM	E27	2700K	800LM	8W	>80	Ø125x175mm	1/25/50
G12511	GLOBE LED BC G125 8W FR DIMM	B22	6000K	800LM	8W	>80	Ø125x175mm	1/25/50
G12512	GLOBE LED ES G125 8W FR DIMM	E27	6000K	800LM	8W	>80	Ø125x175mm	1/25/50

G125 LED Filament Globes (6W) LED Globes

- Input voltage range: 220-250V AC 50/60Hz
- Cap base: aluminium
- Diffuser: amber tinge/ vintage colour glass
- Power factor: ≥0.4
- Ambient temperature: -20 to 50°C
- Not suitable for dimming

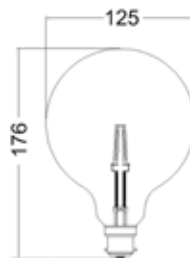

Part No.	Description	Base	Kelvin	Lumens	Watt	CRI	Dimensions	Carton QTY
CF3A	GLOBE LED CARBON LOOK ES G125 (Amber)	E27	2200K	425lm	6=60W	80	Ø125x176mm	1/20
CF4A	GLOBE LED CARBON LOOK BC G125 (Amber)	B22	2200K	425lm	6=60W	80	Ø125x176mm	1/20

G125 LED Globes (6W) LED Globes

- Input voltage range: 90-265V AC 50/60Hz
- Housing & heat sink: aluminium
- Diffuser: clear glass
- LED chips: 21pcs 2835
- Power factor: 0.5
- Ambient temperature: -15 to 40°C
- Not suitable for dimming
- Suitable for use with sensors

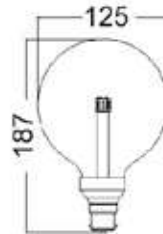

Part No.	Description	Base	Kelvin	Lumens	Watt	CRI	Dimensions	Carton QTY
G1251	GLOBE LED BC G125 6W CLR 3000K	B22	3000K	620LM	6=40W	80	Ø125x187mm	1/20
G1252	GLOBE LED ES G125 6W CLR 3000K	E27	3000K	620LM	6=40W	80	Ø125x187mm	1/20
G1253	GLOBE LED BC G125 6W CLR 5000K	B22	5000K	650LM	6=40W	80	Ø125x187mm	1/20
G1254	GLOBE LED ES G125 6W CLR 5000K	E27	5000K	650LM	6=40W	80	Ø125x187mm	1/20

- Input voltage range: 90-265V AC 50/60Hz
- Housing & heat sink: aluminium
- Diffuser: frosted glass
- LED chips: 21pcs 2835
- Power factor: 0.5
- Ambient temperature: -15 to 40°C
- Not suitable for dimming
- Suitable for use with sensors

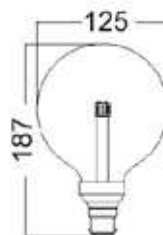

Part No.	Description	Base	Kelvin	Lumens	Watt	CRI	Dimensions	Carton QTY
G1257	GLOBE LED BC G125 6W FR 5000K	B22	5000K	620LM	6=40W	80	Ø125x187mm	1/20
G1258	GLOBE LED ES G125 6W FR 5000K	E27	5000K	620LM	6=40W	80	Ø125x187mm	1/20

Pear LED Filament Globes (8W) LED Globes

- LED filament ST64 dimmable globes
- Input Voltage range: 180-260V AC 50/60Hz
- LED chips: 4x24pcs 5131JC
- Power factor: >0.7
- Ambient temperature: -20 to 50°C
- Suitable for dimming
- Suitable for 2-way switching
- Suitable for use with PIR or Microwave sensors



Tested & Recommended Dimmers:

Brand	Part No.
CLA	VELA
LEGRAND	Cat AR400A3PM
CLIPSAL	32ELEDM, 32E450TM, 31E2RUDM, 32E450UDM
DIGINET	MEDM

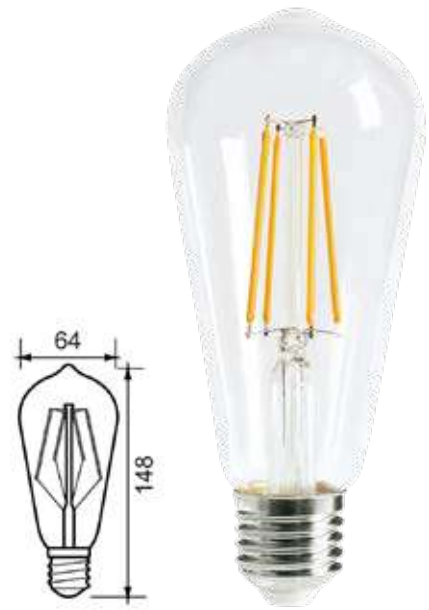

Part No.	Description	Base	Kelvin	Lumens	Watt	CRI	Dimensions	Carton QTY
CF26DIM	GLOBE LED CARBON LOOK BC ST64 8W	B22	2700K	800LM	8=75W	>80	Ø64x140mm	1/25/100
CF27DIM	GLOBE LED CARBON LOOK BC ST64 8W	B22	6000K	800LM	8=75W	>80	Ø64x140mm	1/25/100
CF28DIM	GLOBE LED CARBON LOOK E27 ST64 8W	E27	2700K	800LM	8=75W	>80	Ø64x140mm	1/25/100
CF29DIM	GLOBE LED CARBON LOOK E27 ST64 8W	E27	6000K	800LM	8=75W	>80	Ø64x140mm	1/25/100

ST57 LED Filament Globes (4W)

- Input voltage range: 220-250V AC 50/60Hz
- Cap base: aluminium
- Diffuser: amber tinge/ vintage colour glass
- Power factor: ≥0.4
- Ambient temperature: -15 to 40°C
- Not suitable for dimming



Part No.	Description	Base	Kelvin	Lumens	Watt	Beam Angle	CRI	Dimensions	Carton QTY
CF5A	GLOBE LED CARBON LOOK BC ST57 (Amber)	B22	2200K	380LM	4=40W	360°	80	Ø57x126mm	1/60
CF6A	GLOBE LED CARBON LOOK ES ST57 (Amber)	E27	2200K	380LM	4=40W	300°	80	Ø57x132mm	1/60

PAR38 LED Globes (15W) LED Globes

- Input voltage range: 185-265V AC 50/60Hz
- Driver input: 130mA
- Driver output: 250mA
- Housing: Aluminium & PC
- LED chips: 36pcs SMD2835 LED
- Ambient temperature: -25 to 45°C
- Not suitable for dimming
- Suitable for 2 way switching
- Suitable for use with PIR or Microwave sensors



Part No.	Description	Base	Kelvin	Lumens	Watt	CRI	Dimensions	Carton QTY
SUB3	GLOBE LED ES PAR38 (White P/C) 15W	E27	3000K	1300LM	15W	>80	Ø122x135mm	1/24
SUB4	GLOBE LED ES PAR38 (White P/C) 15W	E27	5000K	1350LM	15W	>80	Ø122x135mm	1/24

PAR30 LED Globes (10W)

- Input voltage range: 185-265V AC 50/60Hz
- Constant current driver included
- Housing: PBT, aluminium & PC
- Heat sink: PBT & aluminium
- LED chips: 10pcs SMD2835
- Power factor: ≥0.5
- Ambient temperature: -10 to 40°C
- Not suitable for dimming
- Suitable for 2-way switching
- Suitable for use with PIR sensor
- Suitable for CLA SEC series security lights



Suitable for CLA SEC series security lights

Part No.	Description	Base	Kelvin	Lumens	Watt	CRI	Dimensions	Carton QTY
PAR3001	GLOBE LED ES PAR30 (Black P/C) 10W 5000K	E27	5000K	800LM	10W	80	Ø96x95mm	1/50

R63 & R80 LED Globes

LED Globes

- Input voltage: 240V AC 50/60Hz
- Aluminium Heatsink with thermal conductive plastic
- Diffuser: frosted PC
- LED chips: SMD2835 LED
- Power factor: 0.5
- Ambient temperature: -20 to 55°C
- Humidity 25+- 2°C ≤90%
- Not suitable for dimming

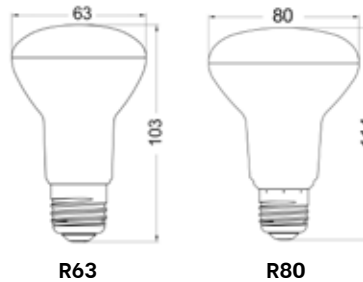

Part No.	Description	Base	Kelvin	Lumens	Watt	CRI	LEDs	Dimensions	Carton QTY
R63L1B	GLOBE LED ES REFL FR R63	E27	3000K	640LM	8=50W	80	7pcs	Ø63x103mm	1/10/100
R63L2B	GLOBE LED ES REFL FR R63	E27	5000K	640LM	8=50W	80	7pcs	Ø63x103mm	1/10/100
R80L1B	GLOBE LED ES REFL FR R80	E27	3000K	810LM	10=65W	80	9pcs	Ø80x114mm	1/50
R80L2B	GLOBE LED ES REFL FR R80	E27	5000K	810LM	10=65W	80	9pcs	Ø80x114mm	1/50

PILOT LED Filament Globe

- Input voltage range: 240V AC 50/60Hz
- Housing: aluminium
- Diffuser: clear glass
- LED chips: 4pcs LED filament
- Power factor: >0.4
- Ambient temperature: -20 to 50°C
- Not suitable for use with dimmers
- Suitable for 2-way switching
- Suitable for use with PIR or microwave sensor

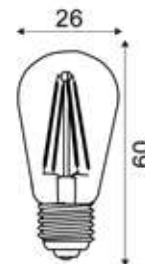

Part No.	Description	Base	Kelvin	Lumens	Watt	CRI	Dimensions	Carton QTY
PILOT01	GLOBE LED PILOT filament 3W 3000K ST26	E14	3000K	300LM	3W	>80	Ø26x60mm	1/25/200

T30 LED Filament Globes

LED Globes

- Input voltage: 220-240V
- Material: amber glass & aluminium
- LED chips: 4x24pcs 5131JC
- Power factor: >0.7
- CRI: >80
- Ambient temperature: -20 to 50°C
- Suitable for use with dimmers
- Suitable for 2-way switching
- Suitable for use with sensors



Tested & Recommended Dimmers:

Brand	Part No.
DIGINET	MEDM
CLA	VELA
CLIPSAL	32ELEDM, 32E450TM, 31E2RUDM, 32E450UDM
LEGRAND	CAT AR400A3PM

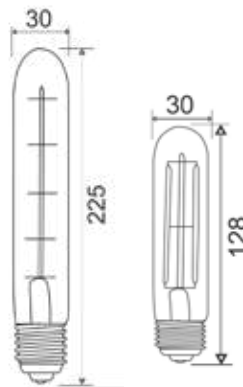

CF46DIM



CF47DIM

Part No.	Description	Kelvin	Lumens	Wattage	Dimensions	Carton QTY
CF46DIM	GLOBE LED DIMM T30 filament	2700K	500LM	5W	Ø30x225mm	1/25/100
CF47DIM	GLOBE LED DIMM T30 filament	2700K	400LM	4W	Ø30x128mm	1/25/100

R7 LED Globes

- Input voltage range: 220-250V AC 50/60Hz
- Heat sink: aluminium
- LED chips: SMD2835 LED
- Power factor: ≥0.5
- Ambient temperature: -20 to 50°C
- Not suitable for dimming
- Suitable for 2 way switching
- Suitable for use with PIR sensors

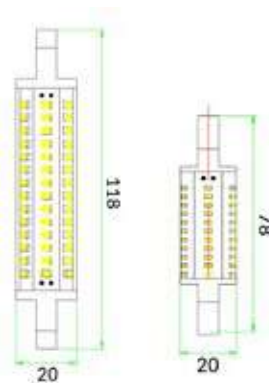

R71A & R72A



R73A & R74A

Part No.	Description	Base	Kelvin	Lumens	Watt	CRI	Dimensions	Carton QTY
R71A	GLOBE LED R7 118mm 8W 3000K 360D	R7	3000K	780LM	8W	80	Ø20x118mm	1/100
R72A	GLOBE LED R7 118mm 8W 5000K 360D	R7	5000K	780LM	8W	80	Ø20x118mm	1/100
R73A	GLOBE LED R7 78mm 4W 3000K 360D	R7	3000K	500LM	4W	80	Ø20x78mm	1/200
R74A	GLOBE LED R7 78mm 4W 5000K 360D	R7	5000K	500LM	4W	80	Ø20x78mm	1/200

R7 LED Globes

LED Globes

- LED R7S globes
- Input Voltage range: 220-240V
- Diffuser: clear glass
- Housing: glass & ceramic
- Heatsink: glass
- LED chips: 1 COB LED
- CRI: >80
- Power factor: >0.5
- Ambient temperature: -20 to 50°C
- Not suitable for dimming
- Suitable for 2 way switching & sensors

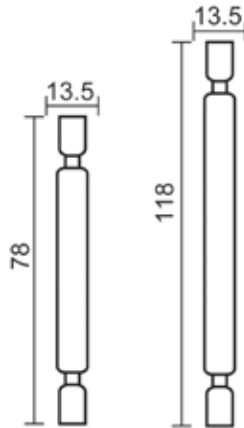

R77 & R78

R75 & R76

Part No.	Description	Base	Kelvin	Lumens	Watt	CRI	Dimensions	Carton QTY
R75	GLOBE LED R7 118mm 8W 3000K 360D	R7	3000K	1000LM	8W	80	Ø13.5x118mm	1/500
R76	GLOBE LED R7 118mm 8W 5000K 360D	R7	5000K	1000LM	8W	80	Ø13.5x118mm	1/500
R77	GLOBE LED R7 78mm 4W 3000K 360D	R7	3000K	400LM	4W	80	Ø13.5x78mm	1/500
R78	GLOBE LED R7 78mm 4W 5000K 360D	R7	5000K	400LM	4W	80	Ø13.5x78mm	1/500

SPECTRA LED Firework Effect Globes LED Globes



- LED firework effect decorative globes
- Input Voltage range: 220-250V AC 50/60Hz
- Power factor: ≥ 0.4
- Heat sink: aluminium
- LED chips: 42pcs SMD2835 LED
- Ambient temperature: -20 to 50°C
- Not suitable for dimming



SPECTRA01



SPECTRA03

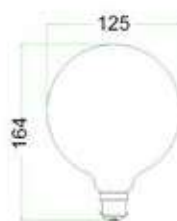

Part No.	Description	Base	Lumens	Watt	CRI	Dimensions	Carton QTY
SPECTRA01	GLOBE LED Firework Effect BC ST57 PEAR 4W	B22	50LM	4W	80	Ø64x140mm	1/100
SPECTRA02	GLOBE LED Firework Effect ES ST57 PEAR 4W	E27	50LM	4W	80	Ø64x140mm	1/100
SPECTRA03	GLOBE LED Firework Effect BC G125 4W	B22	50LM	4W	80	Ø125x164mm	1/20
SPECTRA04	GLOBE LED Firework Effect ES G125 4W	E27	50LM	4W	80	Ø125x164mm	1/20

CHAMA LED Flame Effect Globes LED Globes

- LED decorative flame effect globes
- Input Voltage range: 100–245V AC 50/60Hz
- Heat sink: aluminium & PC
- Diffuser: opal glass
- LED chips: 99pcs SMD2835 LED
- Power factor: ≥ 0.55
- Ambient temperature: -20 to 50°C
- 3 Modes cycle with no memory retention (by turning off and on)
- Not suitable for dimming
- Suitable for 2 way switching



3 modes cycle with no memory retention

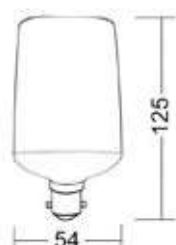

FULLY LIT

FLAME

BEACON

Part No.	Description	Base	Kelvin	Lumens	Watt	CRI	Dimensions	Carton QTY
CHAMA001	GLOBE LED ES FIRE 5W 3 modes	E27	1300K	150LM	5W	-	Ø54x125mm	1/20
CHAMA002	GLOBE LED BC FIRE 5W 3 modes	B22	1300K	150LM	5W	-	Ø54x125mm	1/20

BUG LED Globes

- LED A60 anti insect repellent yellow globes
- Input voltage range: 220–240V AC 50/60Hz
- Yellow tube, insect repelling globes
- Housing & heat sink: Aluminum-plastic
- LED chips: 7pcs SMD2835 LED
- Power factor: 0.5
- Ambient temperature: -20 to 50°C
- Not suitable for dimming
- Suitable for 2 way switching
- Suitable for use with PIR or Microwave sensors



Part No.	Description	Base	Kelvin	Lumens	Watt	CRI	Dimensions	Carton QTY
BUG003	GLOBE LED BC GLS (A60) 7W INSECT YELLOW	B22	1500K	350LM	7W	-	Ø60x110mm	1/100
BUG004	GLOBE LED ES GLS (A60) 7W INSECT YELLOW	E27	1500K	350LM	7W	-	Ø60x113mm	1/100

3U 12V AC/DC LED Globes LED Globes

- Input voltage: 12V AC/DC 50/60Hz
- Nominal current: 1A
- Material: PBT & glass
- LED chips: 48pcs 2835 LED
- Ambient temperature: -15 to 50°C
- Not suitable for dimming
- Recommended iron core(only) transformer & Constant Voltage LED driver



Tested & Recommended Transformers or Drivers:

Brand	Part No.	Type
CLA	CLA113011	LED driver
CLA	CLA115011	LED driver
CLA	CLA1110011	LED driver
CLA	CLA1115011	LED driver
CLA	CLA1120011	LED driver
AQUATRAN	AQ012-050/1415	Iron Core Transformer

Part No.	Description	Base	Kelvin	Lumens	Watt	CRI	Dimensions	Carton QTY
3U001	GLOBE LED 12V AC/DC ES 3U 9W 3000K	E27	3000K	720LM	9W	80	Ø41x140mm	1/10/100
3U002	GLOBE LED 12V AC/DC ES 3U 9W 4000K	E27	4000K	760LM	9W	80	Ø41x140mm	1/10/100
3U003	GLOBE LED 12V AC/DC ES 3U 9W 6500K	E27	6500K	780LM	9W	80	Ø41x140mm	1/10/100

GX53 LED Globes

- Input voltage range: 220-250V AC 50/60hz
- LED chips: 24pcs Epistar LED
- Power factor: ≥0.5
- Ambient temperature: -20 to 50°C
- Not suitable for dimming



Part No.	Description	Base	Kelvin	Lumens	Watt	CRI	Dimensions	Carton QTY
GX53001	GLOBE LED GX53 6W 3000K 180D	GX53	3000K	500LM	6W	80	Ø74x27mm	1/10/100
GX53002	GLOBE LED GX53 6W 5000K 180D	GX53	5000K	520LM	6W	80	Ø74x27mm	1/10/100

G4 LED Globe

- Input voltage: 12V AC/ DC
- Diffuser: clear silicon finish
- Housing: silicon
- Diffuser: PC
- LED chips: 1pc COB LED
- CRI: >80
- Power factor: >0.5
- Ambient temperature: -20 to 50°C
- Not suitable for dimming
- Suitable for 2-way switching
- Suitable for use with PIR sensor
- Remote AC or DC control gear required



Tested & Recommended Drivers / Transformer:

CLADR12WFP, DRIV1, OTTER1, CLA111011, CLA113011, OTTER3, OTTER4, OTTER5, CLA1120011, OTTER7, ETH50.302VA (Transformer)

Part No.	Description	Base	Kelvin	Lumens	Watt	CRI	Dimensions	Carton QTY
G403	GLOBE LED 12V AC/DC G4 1.5W	G4	3000K	150LM	1.5W	>80	Ø11x40mm	100/1000

G4 LED Globe

- Input voltage: 12V AC/ DC
- Material: PC
- Heatsink: ceramic
- Diffuser: PC
- LED chips: 18pcs SMD2835
- CRI: ≥80
- Power factor: 0.5
- Ambient temperature: -10 to 35°C
- Not suitable for dimming
- Suitable for 2-way switching
- Suitable for use with PIR sensor
- Remote AC or DC control gear required

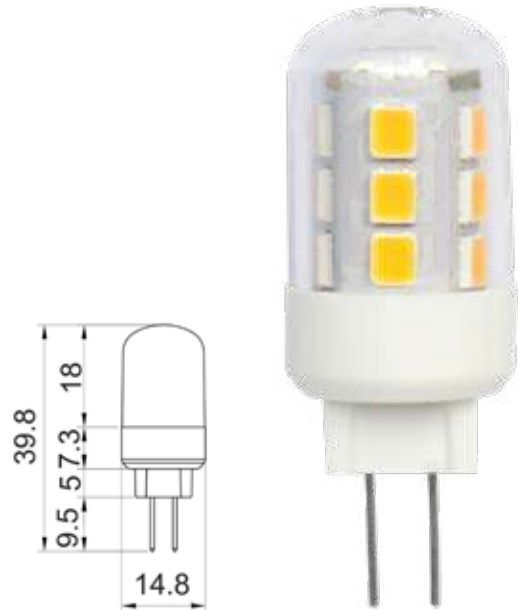

Part No.	Description	Base	Kelvin	Lumens	Watt	CRI	Dimensions	Carton QTY
G401	GLOBE LED 12V AC/DC G4	G4	3000K	160LM	1.5W	≥80	Ø14.8x39.8mm	1/200

G9 LED Globes LED Globes

- Input voltage: 240V AC
- LED chips: SMD2835 LED
- Power factor: >0.4
- Material: ceramic lamp holder & PC diffuser
- Ambient temperature: -20 to 50°C
- Not suitable for dimming

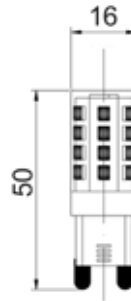

Part No.	Description	Base	Kelvin	Lumens	Watt	CRI	Dimensions	Carton QTY
G90001	GLOBE LED G9 3W 3000K 330D	G9	3000K	240LM	3W	80	Ø16x50mm	1/500
G90002	GLOBE LED G9 3W 5000K 330D	G9	5000K	270LM	3W	80	Ø16x50mm	1/500

PLC LED Globe LED Globes



- Input voltage: 220-240V AC 50/60Hz
- Constant current LED driver inbuilt
- Housing: PC
- Heat sink: aluminium alloy
- Diffuser: PC
- LED chips: 22pcs SMD5630
- Power factor: 0.9
- CRI: 80
- Ambient temperature: -20 to 45°C
- Not suitable for dimming
- Not suitable for 2 way switching
- Not suitable for use with sensors

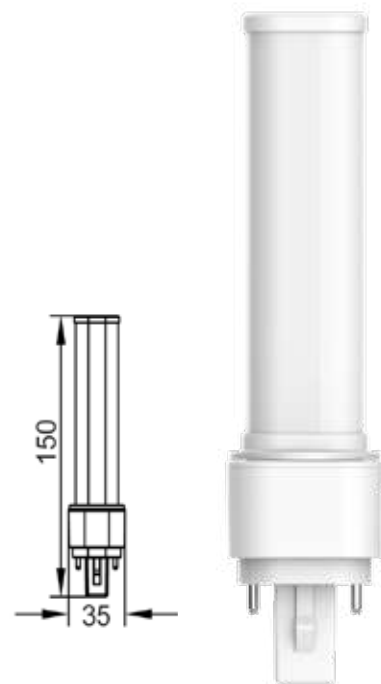

- To be used with magnetic ballast only (2 pin)
- When retrofitting luminaire with electronic ballast, bypass the electronic ballast and rewire the circuit as per the 2nd wiring example shown below.
- 3 year replacement warranty based on max.8hrs usage per day

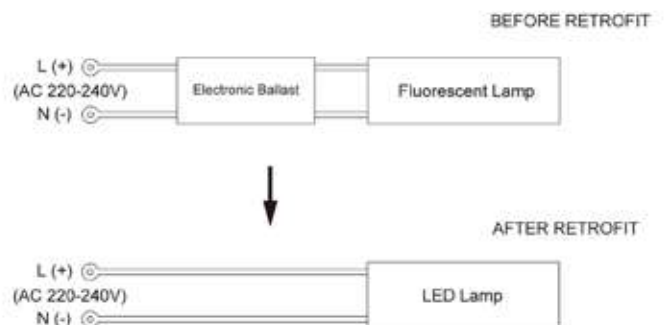

Part No.	Description	Base	Kelvin	Lumens	Watt	CRI	Dimensions	Carton QTY
PLC002	GLOBE LED PLC G24d 2 pin 8W 4000K	G24D	4000K	675LM	8W	80	53x150mm	1/10/50

Elliptical LED Globes LED Globes



- LED elliptical globes
- Input voltage range: 180-240V AC 50/60Hz
- Inbuilt constant current driver included
- No control gear should be in the circuit
- Driver output voltage: 72V
- Housing: PC
- Heat sink: Die cast aluminium
- LED chips: S5 LED
- Power factor: >0.5
- Ambient temperature: -20 to 50°C
- Not suitable for dimming
- Suitable for 2-way switching
- Suitable for use with PIR or Microwave sensors

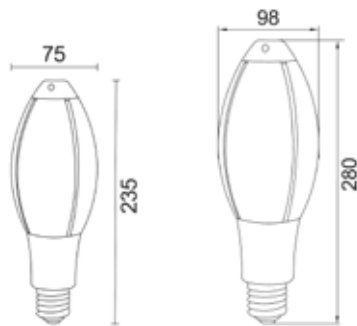

ELLIP01-02

ELLIP03-04



Part No.	Description	Base	Kelvin	Lumens	Watt	CRI	LEDs	Dimensions	Carton QTY
ELLIP01	GLOBE LED ES ELLIPTICAL 25W	E27	3000K	1700LM	25W	80	24pcs S5	Ø75x235mm	1/20
ELLIP02	GLOBE LED ES ELLIPTICAL 25W	E27	5000K	2100LM	25W	80	24pcs S5	Ø75x235mm	1/20
ELLIP03	GLOBE LED E40 ELLIPTICAL 45W	E40	3000K	3100LM	45W	80	48pcs S5	Ø98x280mm	1/10
ELLIP04	GLOBE LED E40 ELLIPTICAL 45W	E40	5000K	3800LM	45W	80	48pcs S5	Ø98x280mm	1/10

T8 LED Tubes LED Globes

- Input voltage range: 220-240V AC 50/60Hz
- Heat sink: PC
- LED chips: SMD2835 LED
- Power factor: ≥ 0.9
- For indoor use only
- Ambient temperature: -20 to 40°C
- Not suitable for use with dimmers
- Suitable for 2-way switching
- Suitable for use with PIR or microwave sensor
- Warranty: please see table below



INSTALLATION INSTRUCTIONS

1. Wiring example of a single circuit luminaire with electronic ballast

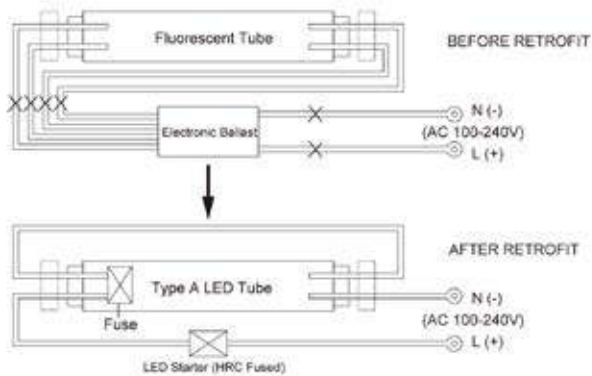

2. Wiring example of a single circuit luminaire with magnetic ballast

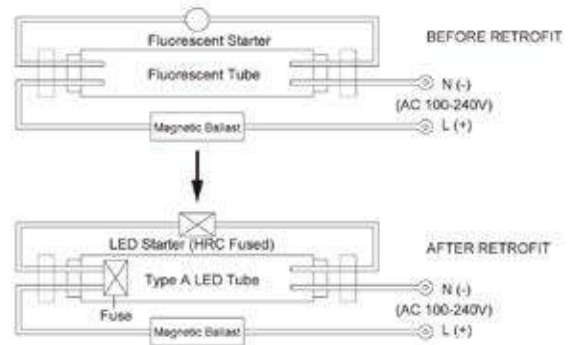

Part No.	Description	Kelvin	Lumens	Watt	CRI	Beam Angle	WTY	Dimensions	Carton QTY
PT82FT4	GLOBE LED T8 TUBE 9W 2FT	6000K	850LM	9W	80	165°	3 year	Ø28x589mm	1/25
PT84FT4A	GLOBE LED T8 TUBE 18W 4FT	6000K	1600LM	18W	80	165°	3 year	Ø28x1198mm	1/25
PT818W5FT	GLOBE LED T8 TUBE 18W 5FT	3000K	1620LM	18W	80	120°	2 year	Ø28x1507mm	1/20
PT827D5FT	GLOBE LED T8 TUBE 27W 5FT	6500K	2700LM	27W	80	165°	3 year	Ø28x1513mm	1/20

CKTRI Oyster Conversion Kits LED Globes

- LED Tri-CCT oyster conversion kits
- Input voltage range: 220-240V AC 50Hz
- Constant current LED driver included
- Clear diffuser: PC
- Heatsink: PCB & aluminium
- Tri-CCT (3000K/ 4000K/ 5000K) switch on driver
- LED chips: SMD2835
- Power factor: >0.8
- CRI: 80
- Not suitable for dimming
- 2 wire input
- Suitable for 2 way switching
- Suitable for use with PIR or Microwave sensors
- Ambient temperature: -20 to 45°C
- Suitable for commercial use

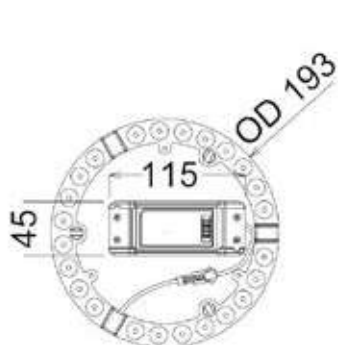

Internal Diameter: 153

CKTRI01

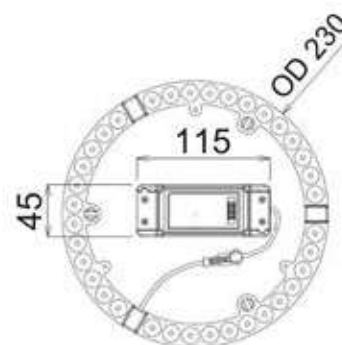

Internal Diameter: 190

CKTRI02 & CKTRI03

Part No.	Description	Lumens			Watt	CRI	Mounting Plate	Carton QTY
		3000K	4000K	5000K				
CKTRI01	GLOBE LED OYSTER CONVERSION KIT Tri-CCT	1000LM	1200LM	1150LM	12W	80	Ø193mm	1/60
CKTRI02	GLOBE LED OYSTER CONVERSION KIT Tri-CCT	1700LM	1800LM	1750LM	18W	80	Ø230mm	1/60
CKTRI03	GLOBE LED OYSTER CONVERSION KIT Tri-CCT	2150LM	2400LM	2250LM	24W	80	Ø230mm	1/60



GLOBES
FLUORESCENT GLOBES

2D Fluorescent Globes Fluorescent Globes

- 2 pin comes with integral starter
- 2 pin only suitable for use with conventional control gear
- 4 pin does not have integral starter
- 4 pin is suitable for use with high frequency electronic control gear
- 8 times the life of incandescent
- 2 pin: GR8 base
- 4 pin: GR10q base
- Not suitable for dimming



Part No.	Description	Base	Kelvin	Lumens	Watt	Dimensions	Carton QTY
2D28WGR10QWW	GLOBE FL GR10Q 2D 4 PIN 28W 3000K	GR10Q	3000K	1800LM	28W	205x207mm	1/40
2D28WGR8DL	GLOBE FL GR8 2D 2 PIN 28W 6400K	GR8	6400K	1930LM	28W	205x207mm	1/40

T5 Circular Fluorescent Globes

- Triphosphor powder coated
- G10q base
- 4 pins together
- Not suitable for dimming



Part No.	Description	Base	Kelvin	Lumens	Watt	Diam	Carton QTY
CLAT532WWW	GLOBE FL G10Q T5 CIRC 32W TRIPHOS 3000K	G10Q	3000K	2200LM	32W	Ø246mm	1/30

T9 Circular Fluorescent Globes

Fluorescent Globes

- Triphosphor powder coated for 20–40% increase in light output and life
- G10q base
- 4 pins together
- Not suitable for dimming



Part No.	Description	Base	Kelvin	Lumens	Watt	Diam	Carton QTY
CLAFCL22WWW	GLOBE FL G10Q T9 CIRC 22W TRIPHOS	G10Q	3000K	1250LM	22W	Ø209mm	1/20
CLAFCL22WCW	GLOBE FL G10Q T9 CIRC 22W TRIPHOS	G10Q	4000K	1250LM	22W	Ø209mm	1/20
CLAFCL22WNW	GLOBE FL G10Q T9 CIRC 22W TRIPHOS	G10Q	5000K	1250LM	22W	Ø209mm	1/20
CLAFCL22WDL	GLOBE FL G10Q T9 CIRC 22W TRIPHOS	G10Q	6400K	1250LM	22W	Ø209mm	1/20
CLAFCL32WCW	GLOBE FL G10Q T9 CIRC 32W TRIPHOS	G10Q	4000K	2200LM	32W	Ø307mm	1/20
CLAFCL32WNW	GLOBE FL G10Q T9 CIRC 32W TRIPHOS	G10Q	5000K	2100LM	32W	Ø307mm	1/20
CLAFCL32WDL	GLOBE FL G10Q T9 CIRC 32W TRIPHOS	G10Q	6400K	2100LM	32W	Ø307mm	1/20
CLAFCL40WWW	GLOBE FL G10Q T9 CIRC 40W TRIPHOS	G10Q	3000K	2850LM	40W	Ø400mm	1/20
CLAFCL40WCW	GLOBE FL G10Q T9 CIRC 40W TRIPHOS	G10Q	4000K	2850LM	40W	Ø400mm	1/20
CLAFCL40WNW	GLOBE FL G10Q T9 CIRC 40W TRIPHOS	G10Q	5000K	2850LM	40W	Ø400mm	1/20

T5 Tube Fluorescent Globes

- Excellent colour rendering
- G5 base
- Can be used indoors and outdoors
- Not suitable for dimming



Part No.	Description	Base	Kelvin	Lumens	Watt	Dimensions	Carton QTY
CLAT514WWW	GLOBE FL G5 T5 TUBE 14W 3000K	G5	3000K	1230LM	14W	Ø17x549mm	1/200
CLAT514WNW	GLOBE FL G5 T5 TUBE 14W 5000K	G5	5000K	1140LM	14W	Ø17x549mm	1/100

PL DU Fluorescent Globes

Fluorescent Globes

- 8 times the life of incandescent globes
- Excellent colour rendering
- Double U tube fluorescent
- 2 pin comes with integral starter
- 2 pin only suitable for use with conventional control gear
- Not suitable for dimming



Part No.	Description	Base	Kelvin	Lumens	Watt	Dimensions	Carton QTY
DU10WG24D1WW	GLOBE FL G24d-1 PLC 2 PIN 10W 3100K	G24d-1	3100K	630LM	10W	35x115mm	1/50
DU10WG24D1CW	GLOBE FL G24d-1 PLC 2 PIN 10W 4200K	G24d-1	4200K	630LM	10W	35x115mm	1/50
DU13WG24D1WW	GLOBE FL G24d-1 PLC 2 PIN 10W 3100K	G24d-1	3100K	880LM	13W	35x115mm	1/50
DU18WG24D2WW	GLOBE FL G24d-2 PLC 2 PIN 18W 3100K	G24d-2	3100K	1160LM	18W	35x153mm	1/100

PL DUE Fluorescent Globes

- 8 times the life of incandescent globes
- Excellent colour rendering
- 4 pin comes with integral starter
- 4 pin is suitable for use with AC mains, DC mains, solar cell & batteries etc
- Not suitable for dimming



Part No.	Description	Base	Kelvin	Lumens	Watt	Dimensions	Carton QTY
DUE18WG24D2WW	GLOBE FL G24q-2 PLC 4 PIN 18W	G24Q-2	3100K	1180LM	18W	35x146mm	1/100
DUE18WG24D2CW	GLOBE FL G24q-2 PLC 4 PIN 18W	G24Q-2	4200K	1180LM	18W	35x146mm	1/100
DUE26WWW4PIN	GLOBE FL G24q-3 PLC 4 PIN 26W	G24Q-3	3100K	1500LM	26W	35x168mm	1/100



GLOBES

CARBON FILAMENT GLOBES

G95 Carbon Filament Globes

Carbon Filament Globes

- Decorative globes
- Input voltage range: 220-240V AC 50/60Hz
- Power factor: 1.0
- Ambient temperature: -30 to 100°C
- Suitable for dimming
- **Not recommended for fan lights**

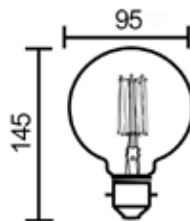

Part No.	Description	Base	Kelvin	Lumens	Watt	Dimensions	Carton QTY
CLACFA25BC	GLOBE CARBON BC G95 25W 2000K	B22	2000K	50LM	25W	Ø95x145mm	1/10/50
CLACFA25ES	GLOBE CARBON ES G95 25W 2000K	E27	2000K	50LM	25W	Ø95x145mm	1/10/50

G125 Carbon Filament Globes

- Decorative globes
- Input voltage range: 220-240V AC 50/60Hz
- Power factor: 1.0
- Ambient temperature: -30 to 100°C
- Suitable for dimming
- **Not recommended for fan lights**

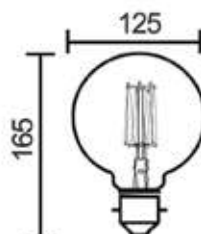

Part No.	Description	Base	Kelvin	Lumens	Watt	Dimensions	Carton QTY
CLACFB25BC	GLOBE CARBON BC G125 25W 2000K	B22	2000K	50LM	25W	Ø125x165mm	1/10/20
CLACFB25ES	GLOBE CARBON ES G125 25W 2000K	E27	2000K	50LM	25W	Ø125x165mm	1/10/20

ST57 Carbon Filament Globes

Carbon Filament Globes

- Decorative globes
- Input voltage range: 220-240V AC 50/60Hz
- Power factor: 1.0
- Ambient temperature: -30 to 100°C
- Suitable for dimming
- **Not recommended for fan lights**

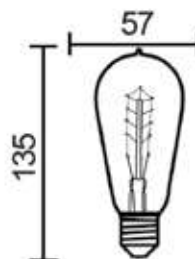

Part No.	Description	Base	Kelvin	Lumens	Watt	Dimensions	Carton QTY
CLACFC25BC	GLOBE CARBON BC ST57 25W 2000K	B22	2000K	50LM	25W	Ø57x135mm	1/10/50
CLACFC25ES	GLOBE CARBON ES ST57 25W 2000K	E27	2000K	50LM	25W	Ø57x135mm	1/10/50

T45 Carbon Filament Globes

- Decorative globes
- Input voltage range: 220-240V AC 50/60Hz
- Power factor: 1.0
- Ambient temperature: -30 to 100°C
- Suitable for dimming
- **Not recommended for fan lights**

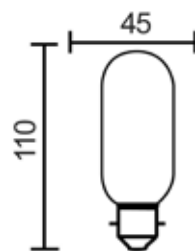

Part No.	Description	Base	Kelvin	Lumens	Watt	Dimensions	Carton QTY
CLACFD25BC	GLOBE CARBON BC T45 25W 2000K	B22	2000K	50LM	25W	Ø45x110mm	1/10/100
CLACFD25ES	GLOBE CARBON ES T45 25W 2000K	E27	2000K	50LM	25W	Ø45x110mm	1/10/100

T9 Carbon Filament Globes (178mm) Carbon Filament Globes

- Decorative globes
- Input voltage range: 220-240V AC 50/60Hz
- Power factor: 1.0
- Ambient temperature: -30 to 100°C
- Suitable for dimming
- **Not recommended for fan lights**

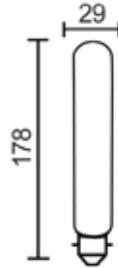

Part No.	Description	Base	Kelvin	Lumens	Watt	Dimensions	Carton QTY
CLACFE25BC	GLOBE CARBON BC T9 25W 2000K	B22	2000K	50LM	25W	Ø29x178mm	1/10/100
CLACFE25ES	GLOBE CARBON ES T9 25W 2000K	E27	2000K	50LM	25W	Ø29x178mm	1/10/100

T9 Carbon Filament Globes (295mm)

- Decorative globes
- Input voltage range: 220-240V AC 50/60Hz
- Power factor: 1.0
- Ambient temperature: -30 to 100°C
- Suitable for dimming
- **Not recommended for fan lights**

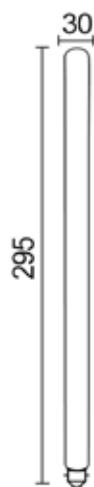

Part No.	Description	Base	Kelvin	Lumens	Watt	Dimensions	Carton QTY
CLACFF25BC	GLOBE CARBON BC T9 25W 2000K	B22	2000K	50LM	25W	Ø30x295mm	1/10/100
CLACFF25ES	GLOBE CARBON ES T9 25W 2000K	E27	2000K	50LM	25W	Ø30x295mm	1/10/100



GLOBES
HEAT LAMP GLOBES

Heat Lamp Globes

Heat Lamp Globes

- Input voltage range: 220–240V AC 50/60Hz
- Power factor: 1.0
- Only available in E27 base
- Suitable for use in bathroom
- Suitable for dimming



Part No.	Description	Base	Kelvin	Lumens	Watt	Dimensions	Carton QTY
CLAHL150W	GLOBE REFL ES HEAT/L 150W 2300K	E27	2300K	800LM	150W	Ø125x185mm	1/10
CLAHL275W	GLOBE REFL ES HEAT/L 275W 2800K	E27	2800K	1800LM	275W	Ø125x185mm	1/40



GLOBES
METAL HALIDE GLOBES

Single Ended MH Globes Metal Halide Globes

- Input voltage: 240V AC with control gear
- Power factor: 0.88
- Ra: 60
- Reduced UV output
- Excellent colour rendering
- High intensity light output
- Not suitable for dimming
- Remote control gear required



Part No.	Description	Base	Kelvin	Lumens	Watt	Length	Carton QTY
CLAMHS35W4000K	GLOBE MH G12 S/ENDED 35W 4000K	G12	4000K	2450LM	35W	95mm	1/10/100
CLAMHS35W5000K	GLOBE MH G12 S/ENDED 35W 5000K	G12	5000K	2450LM	35W	95mm	1/10/100
CLAMHS70W3000K	GLOBE MH G12 S/ENDED 70W 3000K	G12	3000K	4550LM	70W	95mm	1/10/100
CLAMHS150W5000K	GLOBE MH G12 S/ENDED 150W 5000K	G12	5000K	10500LM	150W	95mm	1/10/100

Double Ended MH Globes

- Input voltage: 240V AC with control gear
- Power factor: 0.88
- Ra: 60
- Reduced UV output
- Excellent colour rendering
- High intensity light output
- Not suitable for dimming
- Remote control gear required



Part No.	Description	Base	Kelvin	Lumens	Watt	Length	Carton QTY
CLAMHD35W3000K	GLOBE MH RX7S D/ENDED 35W 3000K	RX7S	3000K	2800LM	35W	114mm	1/100
CLAMHD35W5000K	GLOBE MH RX7S D/ENDED 35W 5000K	RX7S	5000K	2800LM	35W	114mm	1/100
CLAMHD150W3000K	GLOBE MH RX7S D/ENDED 150W 3000K	RX7S	3000K	11250LM	150W	132mm	1/100

Ceramic Double Ended MH Globes Metal Halide Globes

- Input voltage: 240V AC with control gear
- Higher performance than standard metal halide
- Lumen output 85-110 lumen/watt
- Reduced UV output
- Excellent colour rendering 85-95
- High intensity light output
- Not suitable for dimming
- Remote control gear required



Part No.	Description	Base	Kelvin	Lumens	Watt	Dimensions	Carton QTY
CLAMCD150W4K	GLOBE MH RX7S CERAMIC D/ENDED 150W	RX7S	4000K	11400LM	150W	Ø22x138mm	1/12

PAR Ceramic MH Globes

- Input voltage: 240V AC with control gear
- Higher performance than standard metal halide
- Lumen output 85-110 lumen/watt
- Reduced UV output
- Excellent colour rendering 85-95
- High intensity light output
- Not suitable for dimming
- Remote control gear required



Part No.	Description	Base	Kelvin	Lumens	Watt	Dimensions	Carton QTY
CLAMCP3035W10D3K	GLOBE MH ES CERAMIC PAR30 35W 10D	E27	3000K	1700LM	35W	Ø95x122mm	1/6



ACCESSORIES

DECOR LIGHTING ACCESSORIES

CLUSTER Decor Lighting Accessories



CLUSTER1



CLUSTER2



CLUSTER3



CLUSTER4

- Cluster pendant canopies
- Available in 2 designs: Round (Max.6 lights) & Rectangular (Max.11 lights)
- Colour: Matt black / matt white
- Material: iron
- Surface mounted (Mounting bracket included)

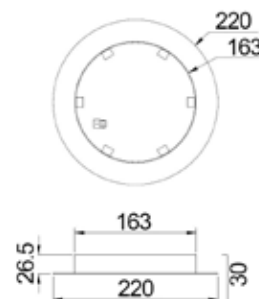
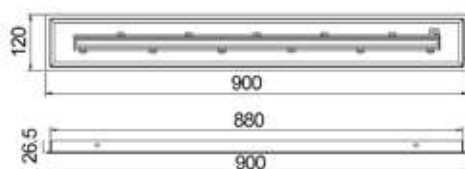
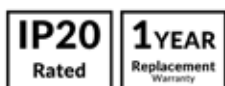

Part No.	Description	Dimensions	Carton QTY
CLUSTER1	RND S/M Cluster Canopy 6 Lights WH	Ø220x26.5mm	1/10
CLUSTER2	RND S/M Cluster Canopy 6 Lights BLK	Ø220x26.5mm	1/10
CLUSTER3	RECT S/M Cluster Canopy 11 Lights WH	900x120x26.5mm	1/10
CLUSTER4	RECT S/M Cluster Canopy 11 Lights BLK	900x120x26.5mm	1/10



ACCESSORIES
CONTROL GEAR

12V Waterproof LED Drivers (IP67) Control Gear

- Input voltage: 170-265V 50/60Hz
- Output voltage: 12V DC
- Short Circuit, Overload and Thermal Protection
- Built in Active PFC Function
- Ambient Temperature: -30 to 50°C
- Flex & Plug Included: 1.2m

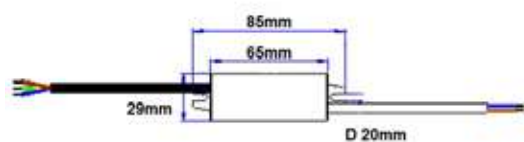

OTTER1



OTTER7

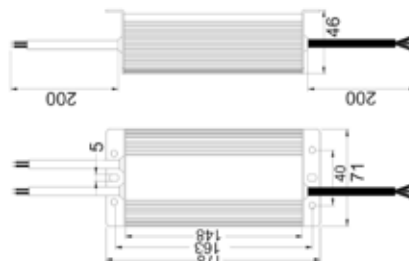

OTTER3-4

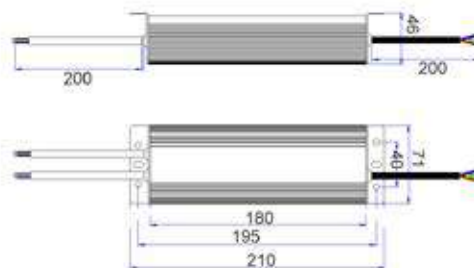

OTTER5

Part No.	Description	Watt	Current	Load	Min.Load per Cable	Max.Load per Cable	Dimensions	Carton QTY
OTTER1	DRIVER LED 12V DC	12W	0.15A	1.2-9.6W	1.2W	9.6W	65x29x20mm	1/25
OTTER3	DRIVER LED 12V DC	50W	4.17A	5-40W	5W	20W	178x71x46mm	1/10
OTTER4	DRIVER LED 12V DC	100W	8.3A	10-80W	10W	40W	178x71x46mm	1/10
OTTER5	DRIVER LED 12V DC	150W	12.5A	15-120W	15W	60W	210x71x46mm	1/10
OTTER7	DRIVER LED 12V DC	300W	25A	30-240W	30W	120W	275x95x50mm	1/5

For OTTER3, OTTER4, OTTER5 & OTTER7

These drivers are manufactured with a split cable format for carrying increased current for easier connection of multiple loads.

Each driver can be used:

- At full load capacity by connecting all cables to one terminal block
- With any combination of split cables (as long as the minimum and maximum loads below are adhered to)

FULL load capacity CANNOT be connected to one cable

12V Waterproof LED Drivers (IP67) Control Gear

- 12V DC constant voltage
- Input voltage: 170-265V AC 50/60Hz
- Output voltage: 12V DC
- Short circuit, overload, over temperature protection
- Ambient temperature: -30 to 50°C
- Flex & plug included



CLA113011

Part No.	Description	Watt	Load	Min. Load Per Cable	Max. Load Per Cable	Dimensions	Carton QTY
CLA111011	DRIVER LED 12V DC C/VOLTAGE 10W	10W	1-8W	1W	8W	120x29x21mm	1/100
CLA113011	DRIVER LED 12V DC C/VOLTAGE 30W	30W	3-24W	3W	24W	182x30x20mm	1/25
CLA1120011	DRIVER LED 12V DC C/VOLTAGE 4x50W	200W	20-160W	5.0W	40W	235x132.2x65mm	1/100

For CLA1120011

These drivers are manufactured with a split cable format for carrying increased current for easier connection of multiple loads.

Each driver can be used:

- At full load capacity by connecting all cables to one terminal block
- With any combination of split cables (as long as the minimum and maximum loads below are adhered to)

FULL load capacity CANNOT be connected to one cable

24V Waterproof LED Drivers (IP67) Control Gear

- Output voltage: 24V DC constant voltage
- Input voltage: 240V AC 50/60Hz
- Short circuit/ Overload/ Over temp protection
- 5% excess VA should be allowed

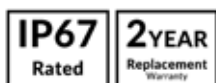

OTTER24V1



OTTER24V3 & OTTER24V4



OTTER24V2

Part No.	Description	Watt	Load	TA	TC	Length	Width	Depth	Carton QTY
OTTER24V1	DRIVER LED 24V DC C/VOLTAGE 12W	12W	1.2-9.6W	40°	80°	65mm	29mm	20mm	1/25
OTTER24V2	DRIVER LED 24V DC C/VOLTAGE 30W	30W	3-24W	40°	80°	166mm	30mm	20mm	1/25
OTTER24V3	DRIVER LED 24V DC C/VOLTAGE 100W	100W	10-80W	40°	80°	162mm	68mm	53mm	1/10
OTTER24V4	DRIVER LED 24V DC C/VOLTAGE 150W	150W	15-120W	40°	80°	215mm	68mm	53mm	1/10

12V Indoor LED Drivers (IP20) Control Gear

- 12V DC constant voltage
- 1-12W output power
- Rated voltage: 240V AC 50/60Hz
- Ambient temperature: -10 to 40°C
- Short circuit protected
- Maximum distance to light source: 2m
- 5% excess VA should be allowed

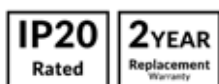

DRIV1

Part No.	Description	Watt	Load	Dimensions	Carton QTY
DRIV1	DRIVER LED 12V DC C/VOLTAGE 1-12W	12W	1.2-9.6W	Ø55x27mm	1/100

12V Indoor LED Drivers (IP20) Control Gear

- 12V DC constant voltage
- 1-12W output power
- Rated voltage: 240V AC 50/60Hz
- 1Amp
- Short cut, overload, electric shock, thermal and main voltage spike protected
- Maximum distance to light source: 2m
- 20% excess VA should be allowed
- Flex & plug: 1.2m



CLADR12WFP

Part No.	Description	Watt	Load	TA	TC	Dimensions	Carton QTY
CLADR12WFP	DRIVER LED 12V DC C/VOLTAGE 1-12W	12W	1.2-9.6W	50°C	75°C	42x116x27mm	1/50

Waterproof Electronic Transformer (IP65)

- IP65 waterproof casing
- Suitable for 12V globes
- Dimmable with leading & trailing edge control gear
- Suitable for outdoor and in ground
- Compatible with C-Bus systems
- Australian Standards Approved
- Soft start to increase globe life by 50%
- Maximum distance to light source: 2m



ETH50.302VA

Part No.	Description	Load	Dimensions	Carton QTY
ETH50.302VA	TRANSFORMER 12V AC Electronic 10-50VA IP65 W/PROOF BLK RND	10-50W	Ø47x29mm	1/100



ACCESSORIES
ELECTRICAL ACCESSORIES

VELA Electrical Accessories - Dimmers

- Push button LED trailing dimmer
- Soft start
- Overload protection & short circuit protection
- Easy to mount in most Australian plates
- Suitable for dimming dimmable LED globes, incandescent globes, high voltage halogen globes, electronic transformers with low voltage halogen globes
- Long press dimming button to dim
- Short press dimming button to on/off
- Comes with 2 face caps round & square edged to suit most Australian plates



Programming:

Minimum brightness setting

- (1) Remove the top cap
- (2) Long press programming button until LED flashes slowly
- (3) Long press dimming button to set level
- (4) Double press dimming button to exit programming mode

Maximum brightness setting

- (1) Remove the top cap
- (2) Long press programming button until LED flashes, short press programming button, until LED starts to flash fast
- (3) Long press dimming button to set level
- (4) Double press dimming button to exit program mode

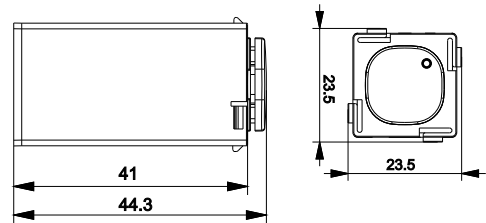

Technical Data:

Part No.	VELA
Nominal Operating Voltage	220-240V
Nominal Operating Frequency	50Hz
Maximum Load	350VA
Minimum Load	10VA
Dimming Technique	Trailing Edge Phase Control
Mounting Centres	84mm Australian Pattern Plate
Safety Compliance	AS/NZS 3100, AS/NZS 3133, IEC 60669-2-1
EMC Compliance	AS/NZS CISPR15, IEC 60669-2-1 (26.1, 26.2), IEC 61000-3-2 (Excepting when used in conjunction with Electronic loads)
Specifications Typical @240V 25°C	
Suitable for Indoor Use only	
No User Serviceable Parts Inside	

DIMERIS Electrical Accessories - Dimmers

- Push button LED trailing dimmer
- Soft start
- Overload protection & short circuit protection
- Easy to mount in most Australian plates
- Suitable for dimming dimmable LED globes, incandescent globes, high voltage halogen globes, electronic transformers with low voltage halogen globes
- Long press dimming button to dim
- Short press dimming button to on/off
- Comes with 2 face caps round & square edged to suit most Australian plates



Part No.	DIMERIS	
Input	Voltage	Max. 10V DC Min. 0.5V DC
Output	Control Current (Max.)	40mA
Environment	Working Temp.	-10°C to 80°C, ambient operating at full load
	Working Humidity	20% to 90% RH non-condensing
	Storage Temp. Humidity	-20°C to 80°C, 10% to 90% RH
Connection	To Dimmable Input Port	UL rated, 20AWG for '+' and '-'
	MTBF	100K Hours min @Ta=25°C
Others	Dimensions (L, W, H)	23mm, 23mm, 54mm
	Compliance with Australian Standard AS/NZS CISPR 15	

- Infrared motion surface mounted sensors
- Available in white and black fitting colour

Part No.	SENS001, SENS002
Mounting Type	Surface Mounted
Input voltage	220-240V AC 50/60Hz
Detection Range	180°
Detection Distance	12m Max (<24°C)
Detection Motion Speed	0.6-1.5m/s
Rated Load	1200W HAL/ 300W CFL/ 300W LED
Time Delay	Min.10sec+3sec Max.15min+2min (Restarts from last movement)
Ambient Light	<3-2000lux (adjustable)
Ambient Temp	-20 to +40°C
Working Humidity	<93%RH
Power Consumption	approx 0.5W
Installation Height	1.8-2.5m
Housing Material	PC
UV Resistant	Yes
3 Wire	Yes
Day/ Night Recognition	Yes
Manual Override	Yes (1) To operate as a light only (i.e. override sensor), turn power off for 3 seconds and then back on (2) To reverse the override function (i.e. re-introduce the use of the sensor), turn power off for 10 seconds and then back on



SENS001



SENS002

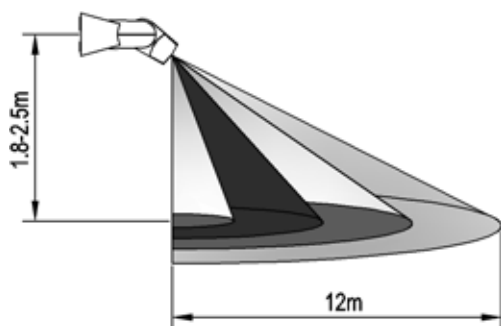
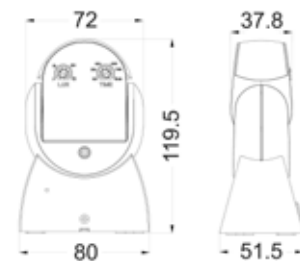

Height of installation: 1.8-2.5m

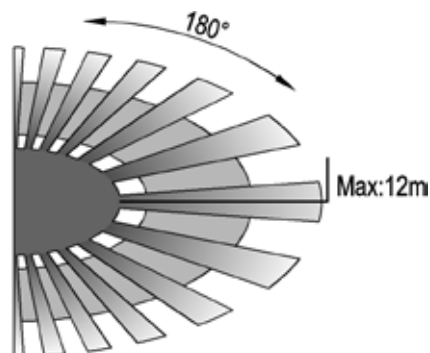

Detection Distance: Max.12m

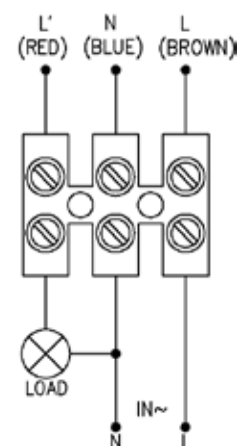

- Infrared motion recessed sensor

Part No.	SENS003
Mounting Type	Recessed
Input voltage	220-240V AC 50/60Hz
Detection Range	360°
Detection Distance	6m Max (<24°C)
Detection Motion Speed	0.6-1.5m/s
Rated Load	1200W HAL/ 300W CFL / 300W LED
Time Delay	Min.10sec+3sec Max.15min+2min (restarts from last movement)
Ambient Light	<3-2000lux (adjustable)
Ambient Temp	-20 to +40°C
Working Humidity	<93%RH
Power Consumption	approx 0.5W
Installation Height	2.2-4m
Housing Material	PC
UV Resistant	Yes
3 Wire	Yes
Day/ Night Recognition	Yes
Manual Override	Yes (1) To operate as a light only (i.e. override sensor), turn power off for 3 seconds and then back on (2) To reverse the override function (i.e. re-introduce the use of the sensor), turn power off for 10 seconds and then back on



SENS003

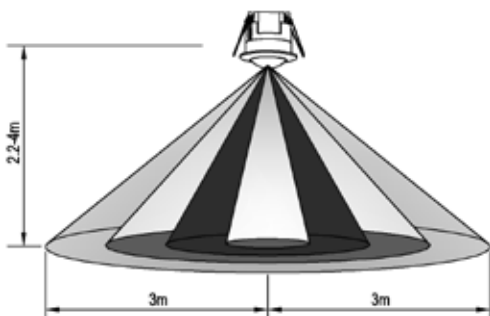
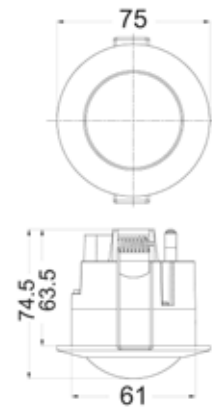

Height of installation: 2.2-4m

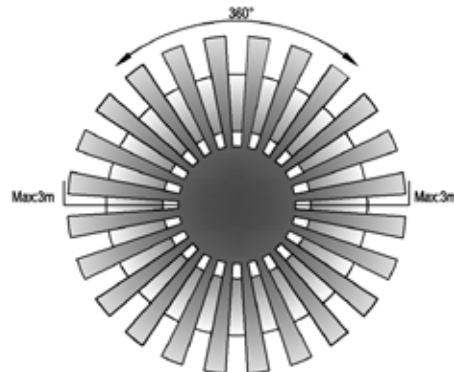

Detection Distance: Max.6m

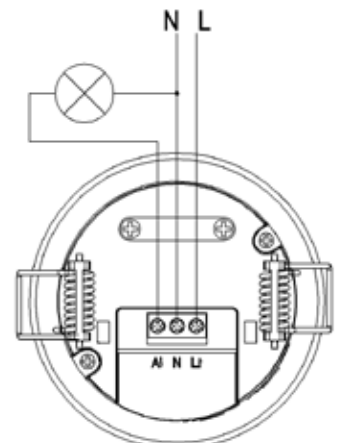

- Infrared motion surface mounted sensor

Part No.	SENS004
Mounting Type	Surfacc
Input voltage	220-240V AC 50/60Hz
Detection Range	360°
Detection Distance	6m Max (<24°C)
Detection Motion Speed	0.6-1.5m/s
Rated Load	2000W HAL/ 1000W CFL/ 1000W LED (If lamp higher than 60W is used the distance between lamp & sensor should be a minimum of 60cm)
Time Delay	Min.10sec±3sec Max.15min±2min (restarts from last movement)
Ambient Light	<3-2000lux (adjustable)
Ambient Temp	-20 to +40°C
Working Humidity	<93%RH
Power Consumption	approx 0.5W
Installation Height	2.2-4m
Housing Material	PC
UV Resistant	Yes
3 Wire	Yes
Day/ Night Recognition	Yes
Manual Override	Yes (1) To operate as a light only (i.e. override sensor), turn power off for 3 seconds and then back on (2) To reverse the override function (i.e. re-introduce the use of the sensor), turn power off for 10 seconds and then back on



SENS004

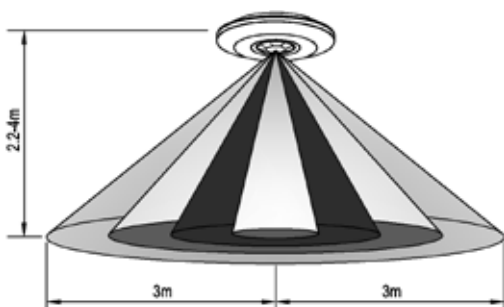
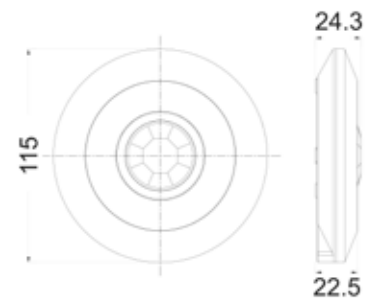

Height of installation: 2.2-4m

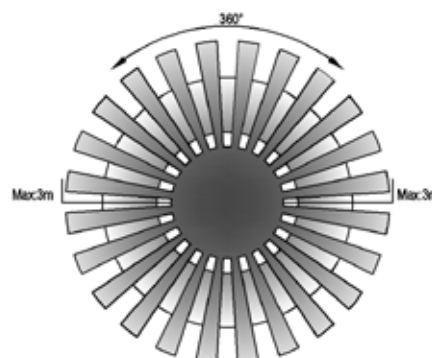

Detection Distance: Max.6m

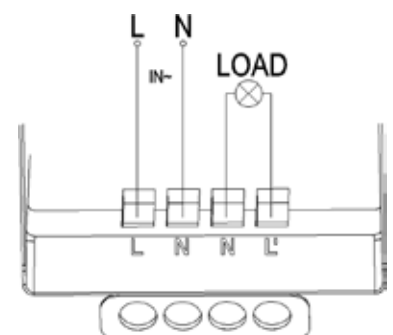

- Infrared motion surface mounted sensor

Part No.	SENS005
Mounting Type	Surface Mounted
Input voltage	220-240V AC 50/60Hz
Detection Range	360°
Detection Distance	20m Max (<24°C)
Detection Motion Speed	0.6-1.5m/s
Rated Load	2000W HAL/ 1000W CFL/ 1000W LED
Time Delay	Min.10sec+3sec Max.30min+2min (restarts from last movement)
Ambient Light	<3-2000lux (adjustable)
Ambient Temp	-20 to +40°C
Working Humidity	<93%RH
Power Consumption	approx 0.5W
Installation Height	2.2-6m
Housing Material	PC
UV Resistant	Yes
3 Wire	Yes
Day/ Night Recognition	Yes
Manual Override	Yes (1) To operate as a light only (i.e. override sensor), turn power off for 3 seconds and then back on (2) To reverse the override function (i.e. re-introduce the use of the sensor), turn power off for 10 seconds and then back on



SENS005

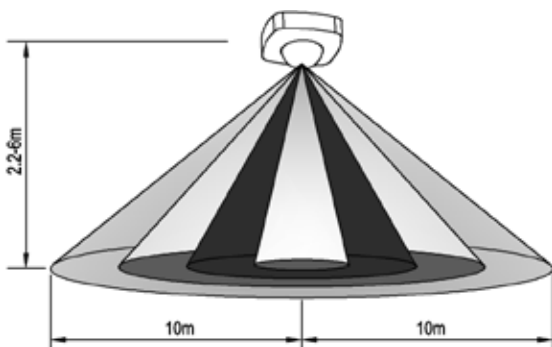
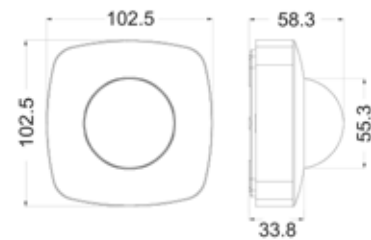

Height of installation: 2.2-6m

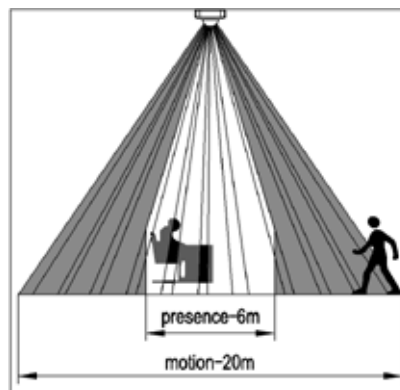

Detection Distance: Max.20m

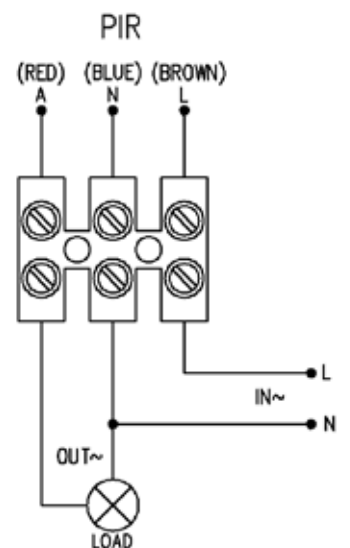

- Adjustable infrared motion surface mounted sensors
- Available in white and black fitting colour
- Adjustable head
- New improved knuckle

Part No.	SENS007, SENS008
Mounting Type	Surface Mounted
Input voltage	220-240V 50/60Hz
Detection Range	120°
Detection Distance	12m Max (<24°C)
Motion Detection Speed	0.6-1.5m/s
Rated Load	2000W HAL/ 1000W CFL/ 1000W LED
Time Delay	Min.10sec±3sec Max.30min±2min (restarts from last movement)
Ambient Light	3-2000Lux
Ambient Temp	-20 to 40°C
Working Humidity	<93%RH
Power Consumption	approx. 0.5W
Installation Height	1.8-2.5m
Housing Material	PC
UV Resistant	Yes
3 Wire	Yes
Day/ Night Recognition	Yes
Manual Override	Yes (1) To operate as a light only (i.e. override sensor), turn power off for 3 seconds and then back on (2) To reverse the override function (i.e. re-introduce the use of the sensor), turn power off for 10 seconds and then back on

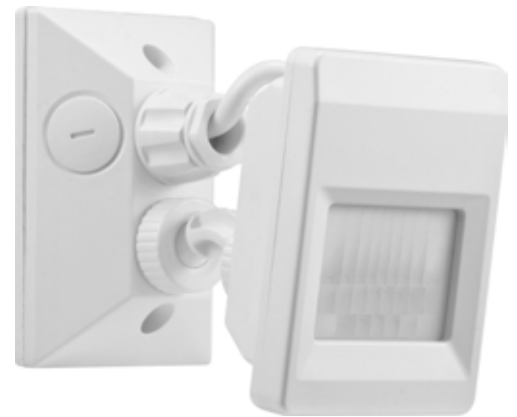

SENS007



SENS008

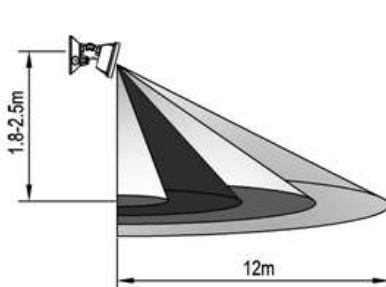
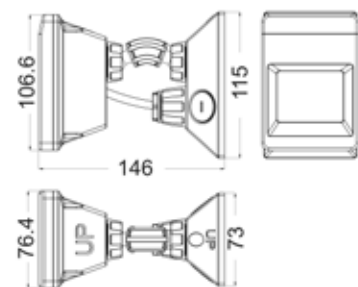

Height of installation: 1.8-2.5m

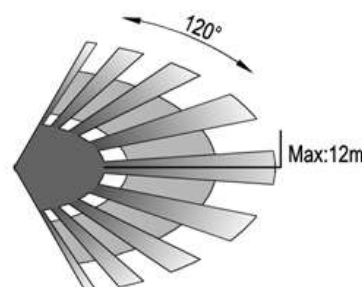

Detection Distance: Max.12m

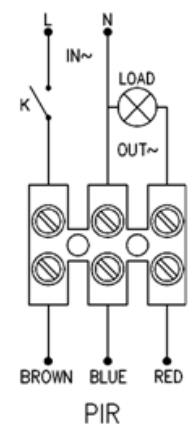

- Adjustable infrared PIR surface mounted sensors
- Available in white and black
- Adjustable head (90° up or down)

Part No.	SENS009, SENS010
Mounting Type	Surface Mounted
Input voltage	220-240V 50/60Hz
Detection Range	360°
Detection Distance	20m Max (<24°C)
Motion Detection Speed	0.6-1.5m/s
Rated Load	2000W HAL/ 1000W CFL/ 1000W LED
Time Delay	Min.10sec+3sec Max.30min±2min (restarts from last movement)
Ambient Light	3-2000Lux (adjustable)
Ambient Temp	-20 to 40°C
Working Humidity	<93%RH
Power Consumption	approx. 0.5W
Installation Height	2.2-6m
Housing Material	PC
UV Resistant	Yes
3 Wire	Yes
Day/ Night Recognition	Yes
Manual Override	Yes



SENS009



SENS010

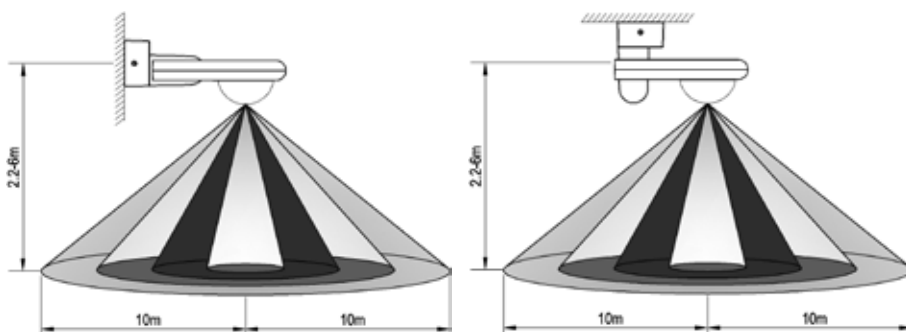
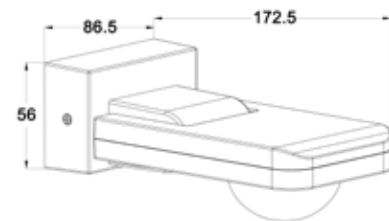

Height of Installation: 2.2-6m

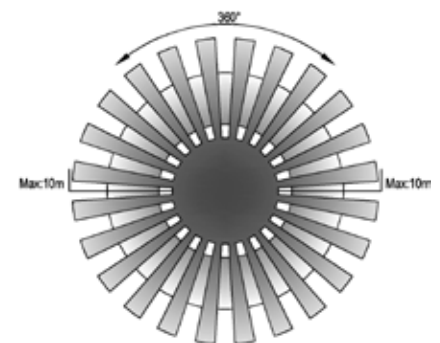

Detection Distance: Max.20m

- Microwave sensor
- To be installed inside a fitting

Part No.	SENS011
Mounting Type	To be installed inside a fitting
Input voltage	220-240V AC 50Hz
Detection Range	360°
Detection Distance	1-8m (radius) adjustable
Detection Motion Speed	0.6-1.5 m/s
Rated Load	1200W HAL/ 300W CFL/ 300W LED
Hold time	Min. 10 sec ± 3sec Max. 12 min ± 1 min
HF System	5.8 GHz CW radar, ISM band
Ambient Light	<3-2000LUX (adjustable)
Ambient Temp	-20 to 50°C
Power consumption	0.9W
Installation Height	2-6m
Housing Material	PC
IP Rating	IP20
Warranty	5 years replacement
Does not operate through metal	
UV resistant	
No manual override	



SENS011

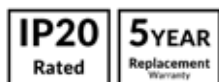
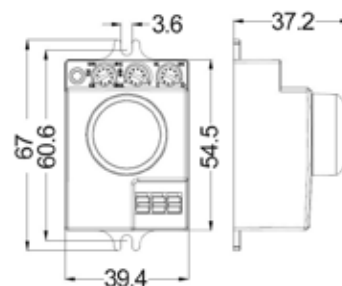

TESTING IN DAYLIGHT:

- Turn the LUX dial clockwise to MAXIMUM (sun). Turn the SENS dial clockwise to MAXIMUM (+). Turn the TIME dial anti-clockwise to MINIMUM (10s)

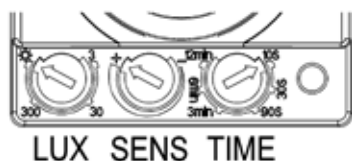

- Switch on the power: The light fitting will turn on and 10sec±3sec later, the light will turn off automatically. If the sensor detects movement, the light will turn on again.
- If no additional movement is detected after 10s (time pre-set in TIME dial for testing purpose), the light will turn off. If the sensor receives a new induction signal before the 10 seconds are up, the timer will restart from when the last movement was detected.

TESTING AT NIGHT:

- Turn LUX dial anti-clockwise to MINIMUM (3). If the ambient light is less than 3LUX, the light will turn on when movement detected.
- If no additional movement is detected after 10s (time pre-set in TIME dial for testing purpose), the light will turn off. If the sensor receives a new induction signal before the 10 seconds are up, the timer will restart from when the last movement was detected.

Once testing is complete, adjust the LUX, SENS and TIME dials as desired.

CONN (IP68) Electrical Accessories - Connectors

- Waterproof connectors
- Copper Cabling max - 4mm braidedW
- Screw Terminal Material: Brass with Ni Plated
- High Temperature rating: -40°C to 105°C
- Silicon Gel gasket
- Nylon glass fiber reinforced (PA66 + GF V0)
- **If using flat sheathed cable, connector ends need to be sealed with waterproof compound.**

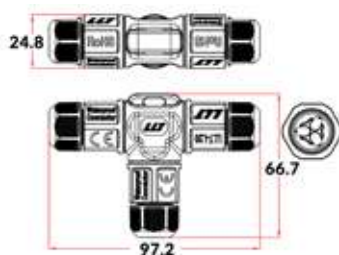
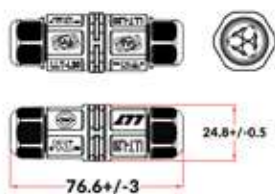
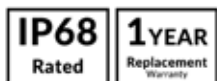

CONN001



CONN002

Part No.	Description	Current Rating	Voltage Rating	Contact Resistance	Breakdown Voltage	Circular Cable Diam	Carton QTY
CONN001	CONNECTOR / 2 Way Cable Extension	25A	380V AC	100Mohm at 500V	1500V/1Min 5mA	6.5-10	1/500
CONN002	CONNECTOR / 3 Way Cable Extension	25A	380V AC	100Mohm at 500V	1500V/1Min 5mA	6.5-10	1/250

CONN (IP20) Electrical Accessories - Connectors

- Single or double cable connectors
- Construction material: Transparent PC
- Screw material: copper
- Wiring hole: 6mm
- Max.current: 32A
- CONN003: Box QTY 100pcs only
- CONN004: Box QTY 50pcs only



CONN003



CONN004

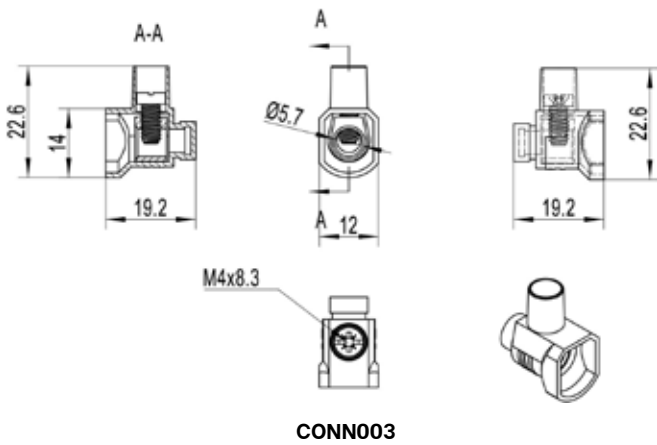

CONN003

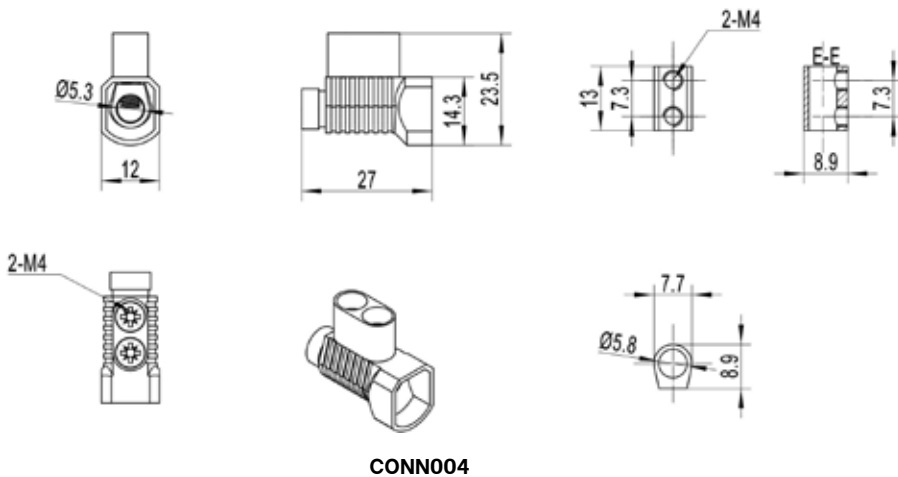

CONN004

Part No.	Description	Max. Current	Wiring Hole	Dimensions	Carton QTY
CONN003	CONNECTOR Single Cable Transparent PC with Copper	32A	1x6mm ²	19.2x12x22.6mm	100/4500
CONN004	CONNECTOR Double Cable 32A Transparent PC	32A	2x6mm ²	27x12x23.5mm	50/1250

SADDLE Electrical Accessories - Saddles



- Stainless steel / alloy steel saddles
- SADDLE001-004 material: stainless steel 304
- SADDLE005-008 material: alloy steel
- Box QTY 100pcs only (SADDLE002: 50pcs)



SADDLE001 & 002



SADDLE003 & 004



SADDLE007 & 008



SADDLE005 & 006

Part No.	Description	Carton QTY
SADDLE001	SADDLE Half STAINLESS STEEL 20mm 6.6mm hole	100/1K
SADDLE002	SADDLE HALF STAINLESS STEEL 25mm 5.6mm hole	50/400
SADDLE003	SADDLE FULL STAINLESS STEEL 20mm 5.6mm hole	100/1K
SADDLE004	SADDLE FULL STAINLESS STEEL 25mm 5.6mm hole	100/1K
SADDLE005	SADDLE HALF ALLOY STEEL 20mm 6.6mm hole	100/1K
SADDLE006	SADDLE HALF ALLOY STEEL 25mm 5.6mm hole	100/1K
SADDLE007	SADDLE FULL ALLOY STEEL 20mm 5.6mm hole	100/1K
SADDLE008	SADDLE FULL ALLOY STEEL 25mm 5.6mm hole	100/1K

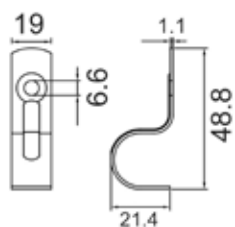

SADDLE001

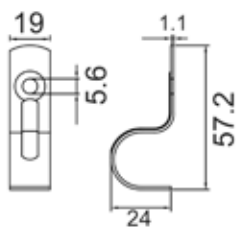

SADDLE002

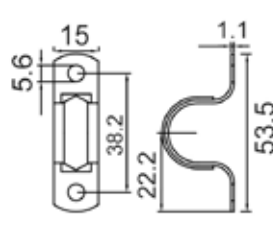

SADDLE003

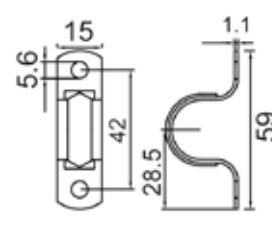

SADDLE004

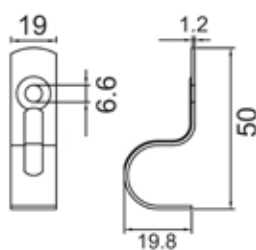

SADDLE005

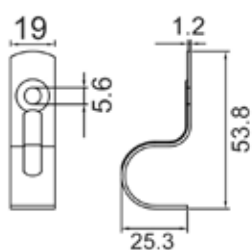

SADDLE006

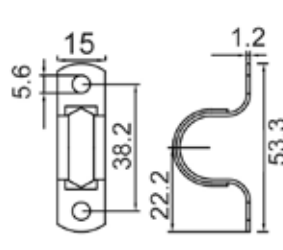

SADDLE007

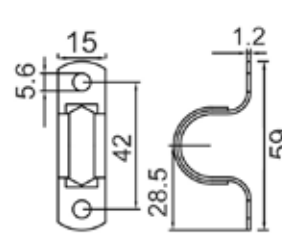

SADDLE008

SOCK Electrical Accessories - Sockets

- 3-Pin quick connection surface socket
- 240V 50Hz
- Material: PC
- 10Amp current rating
- Recommended cable: 1.0mm to 2.5mm
- Product is earthed
- The cable must be stripped back first before placing cable in the socket
- Box QTY of 10pcs only

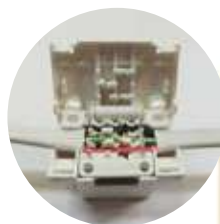

SOCK2

Part No.	Description	Carton QTY
SOCK2	SOCKET Quick Connect Single Surface 3 Pin PLUG BASE 10 Amp Earthed	1/10/200

- 3-Pin rear connecting single surface socket
- 240V/50Hz
- Material: PC
- 10Amp current rating
- Recommended cable: 1.0mm to 2.5mm
- Product is earthed
- Side entry for cable
- Polarity sensitive
- Box QTY of 10pcs only



SOCK3

Part No.	Description	Carton QTY
SOCK3	SOCKET Quick Connect Single Surface 3 Pin PLUG BASE 10 Amp Earthed	1/10/200

GPO Electrical Accessories - Sockets

- Waterproof surface sockets
- Rated voltage: 250V
- Rated current: 10A
- Inside Mech: PA66
- Outer shell: Polycarbonate
- Earthed
- For residential or general use
- IP53 rated weatherproof
- Dustproof, anti-chemical corrosion, anti-ultraviolet, anti-impact, anti-aging, anti-aging oil, anti-splash
- Can be used in gardens, outdoor areas, swimming pools or tennis courts, etc
- Numerous conduit entries
- On/off slide switch

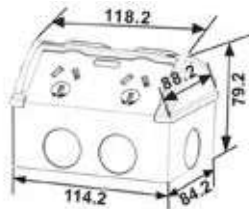
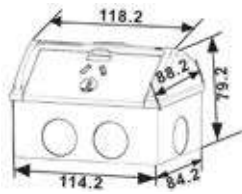

GPO01



GPO02

Part No.	Description	Carton QTY
GPO01	SOCKET SINGLE GPO Weatherproof 250V 10A	1/40
GPO02	SOCKET DOUBLE GPO Weatherproof 250V 10A	1/40

BATFIX Electrical Accessories - Batten Fixture

- 250V/50Hz
- Material: PC
- 10A current rating
- 4 terminals
- Lugs and screws included
- Box QTY of 10pcs only



BATFIX01

Part No.	Description	Carton QTY
BATFIX01	BATTEN FIXTURE BC 10AMP 250V	10/100

Flex & Plug with Inline Switch Electrical Accessories - Flex & Plug

- From plug to switch 1.8m
- From switch to connection 106cm



Part No.	Description	Carton QTY
FP2WSB	FLEX & PLUG 240V POWER CORD with inline switch 2900MM BLK	1/100
FP2WSW	FLEX & PLUG 240V POWER CORD with inline switch 2900MM WH	1/100

Flex & Plug Electrical Accessories - Flex & Plug



FP2M/3M3WWH

Part No.	Description	Carton QTY
FP1.2M2W	FLEX & PLUG 240V (for 12V) (1200mm) 2 WIRE	1/100
FP2M2W	FLEX & PLUG 240V (for 12V) (2000mm) 2 WIRE	1/50
FP2M3W	FLEX & PLUG 240V (2000mm) 3 WIRE	1/50
FP2M2WWH	FLEX & PLUG 240V (for 12V) (2000mm) 2 WIRE (WHITE)	1/1
FP3M2WWH	FLEX & PLUG 240V (for 12V) (3000mm) 2 WIRE (WHITE)	1/1
FP2M3WWH	FLEX & PLUG 240V (2000mm) 3 WIRE (WHITE)	1/1
FP3M3WWH	FLEX & PLUG 240V (3000mm) 3 WIRE (WHITE)	1/1

12V Lamp Holder Electrical Accessories - Lamp Holder



Part No.	Description	Carton QTY
LH0.4M	LAMPHOLDER 12V 400mm (0.40m)	1/1000
LH1.5M	LAMPHOLDER 12V 1500mm (1.50m)	1/250

Plug & Extension Lead Electrical Accessories - Plugs & Leads

- Plugs and extension leads
- Low profile design
- Ideal for domestic use like homes or offices



PLUG001

PLUG002

Part No.	Description	Carton QTY
PLUG001	PLUG TOP Rewirable 3 PIN 10A CLEAR (Male)	1/100
PLUG002	PLUG TOP Rewirable 3 PIN 10A CLEAR (Female)	1/100

- Cable Diameter for LEADW001-005: 3x1.0mm²
- Cable Diameter for LEADB001-009: 3x1.5mm²



LEADB001-009



LEADW001-005

Part No.	Description	Carton QTY
LEADB001	EXTENSION LEAD Piggy Back Black 15A Flex / 10A Plug & Socket 1m	1/60
LEADB002	EXTENSION LEAD Piggy Back Black 15A Flex / 10A Plug & Socket 2m	1/50
LEADB003	EXTENSION LEAD Piggy Back Black 15A Flex / 10A Plug & Socket 3m	1/30
LEADB004	EXTENSION LEAD Piggy Back Black 15A Flex / 10A Plug & Socket 5m	1/20
LEADB005	EXTENSION LEAD Piggy Back Black 15A Flex / 10A Plug & Socket 10m	1/10
LEADB006	EXTENSION LEAD Piggy Back Black 15A Flex / 10A Plug & Socket 15m	1/8
LEADB007	EXTENSION LEAD Piggy Back Black 15A Flex / 10A Plug & Socket 20m	1/6
LEADB008	EXTENSION LEAD Piggy Back Black 15A Flex / 10A Plug & Socket 25m	1/6
LEADB009	EXTENSION LEAD Piggy Back Black 15A Flex / 10A Plug & Socket 30m	1/4
LEADW001	EXTENSION LEAD White 10A 2m	1/50
LEADW002	EXTENSION LEAD White 10A 3m	1/50
LEADW003	EXTENSION LEAD White 10A 5m	1/30
LEADW004	EXTENSION LEAD White 10A 7m	1/20
LEADW005	EXTENSION LEAD White 10A 10m	1/20

Power Boards Electrical Accessories - Power Boards

- Available in 4 power outlets and 6 outlets
- 1m white AC cord with insulated pins
- Overload protection with test button
- Low profile design
- Ideal for home or office use



CLA4PB



CLA6PB

Part No.	Description	Carton QTY
CLA4PB	POWER BOARD 4 SOCKET 1000mm FP	1/48
CLA6PB	POWER BOARD 6 SOCKET 1000mm FP	1/48



ACCESSORIES

TEAM BRAND PRODUCTS

TP001 Team Brand Products

- Tyre pump
- Inflates 205/65R15 tyre to 40psi in 15min
- Quality screw on valve fitting
- Zip carry bag
- 2x ball and camping adaptors
- LED light and ON/OFF switch
- 110mm hose, 500mm cable
- 12V DC input
- Dimensions: 105mm x 95mm x 45mm
- Current draw: 2.5A to 6A



TP001

SJS1200 Team Brand Products

- Smart jump start charger - Will jump start MOST vehicles up to 2.8L(2800cc) diesel or up to 6.0L(6000cc) petrol 12,000mAh (44.4Whr) Lithium polymer battery cell
- Size: L 165 x W 75 x H 35mm (Power Pack only)
- Weight: 415g (Power Pack only)
- Battery: 12V Lithium Polymer 12,000mAh (45 Whr) 3S
- Max.Current: 1200A Absolute. 500A PEAK at clamps 200A START at clamps
- Output: Jump Port 2V DC
- Device powering 12V DC up to 180W. Use SSCFCL156 Adapter (Sold separately)
- Digital Charging Ports: USB x3 / 5V 2.1A x2 / 5V 1A x1
- Battery Chargers: AS approved 240V AC/15V 1A DC. 12V DC/15V DC 1A Car Charger
- Recharge Time: 4 hrs from flat with 240V charger, 8hrs with Car charger
- Charge Indicator: Backlit LCD Display screen
- Self Discharge Rate: approx. 0.2V per month depending on ambient storage temperature
- Protection & Safety: Reverse Current , Reverse Polarity, Short Circuit, Overtemp, Overcranking, Surge, Voltage Differential, Overload Reset, Over Charge, Over Discharge
- LED Flashlight: 3 Modes (Full, S.O.S, Emergency Flash)
- Operating temperature: -20 to 60°C



Zip carry case contents:

- 12V 12,000mAh (44.4Whr) Lipo Power Pack
- Insulated Jump Start Safe Jumper Leads
- 240V AC/15V DC 1A Wall Charger
- 12V DC/15V DC 1A car charger
- USB 5V 2 in 1 Adaptor cable
- User manual and Instruction cards



SJS1200

SJS1500 Team Brand Products

- Smart jump start charger - Will jump start MOST vehicles up to 4.2L(4200cc) diesel or up to 7.0L(7000cc) petrol 16,000mAh (60Whr) Lithium polymer battery cell
- Size: L 185 x W 85 x H 38mm (Power Pack only)
- Weight: 550g (Power Pack only)
- Battery: 12V Lithium Polymer 16,000mAh (60 Whr) 3S
- Max.Current: 1500A Absolute. 600A PEAK at clamps 300A START at clamps
- Output: Jump Port 2V DC
- Device powering 12V DC up to 180watts. Use SSCFL156 Adapter (Sold separately)
- Digital Charging Ports: USB x2 / 5V 2.1A x1 / 5V 1A x1
- Battery Chargers: AS approved 240V AC/15V 1A DC. 12V DC/15V DC 1A Car Charger
- Recharge Time: 4 hrs from flat with 240V charger, 8hrs with Car charger
- Charge Indicator: Backlit LCD Display screen
- Self Discharge Rate: approx. 0.2V per month depending on ambient storage temperature
- Protection & Safety: Reverse Current, Reverse Polarity, Short Circuit, Overtemp, Overcranking, Surge, Voltage Differential, Overload Reset, Over Charge, Over Discharge
- LED Flashlight: 3 Modes (Full, S.O.S, Emergency Flash)
- Operating temperature: -20 to 60°C



Zip carry case contents:

- 12V 16,000mAh (60Whr) Lithium Polymer Power Pack
- Insulated Jump Start Safe Jumper Leads
- 240V AC/15V DC 1A Wall Charger
- 12V DC/15V DC 1A car charger
- USB 2 in 1 Adaptor cable
- User manual and Instruction cards



SJS1500

SJS1500TP

- Smart jump start charger - Will jump start MOST vehicles up to 4.2L(4200cc) diesel or up to 7.0L(7000cc) petrol 16,000mAh (60Whr) Lithium polymer battery cell
- **Tyre pump included**
- Other technical spec is the same with SJS1500TP



Zip carry case contents:

- 12V 16,000mAh (60Whr) Lithium Polymer Power Pack
- Insulated Jump Start Safe Jumper Leads
- 240V AC/15V DC 1A Wall Charger
- 12V DC/15V DC 1A car charger
- USB 2 in 1 Adaptor cable
- User manual and Instruction cards
- Tyre pump included



SJS1500TP

SJS3000 Team Brand Products

- Smart jump start charger - Will jump start MOST vehicles up to 7.0L (7000cc) diesel or up to 10.0L (10000cc) petrol
- Battery: 12V Lithium Polymer 32,000mAh (118.4hr) 6S 2P 3.7v per cell
- Max. Current: 3000A Absolute / 1200 A PEAK at clamps / 800a START at clamp
- Output: 12V DC
- Protection for: Over discharge Protection/ Reverse Current/ Reverse Polarity/ Short circuit/ Overtemp/ Over cranking/ Surge/ Voltage Differential/ Overload Reset/ Over Charge/ Over Discharge
- Charge Time of Power Pack from flat: 4 hours for 240V Wall charger or 8 hours from Car Charger
- Suitable to Emergency Jump Start Vehicles max 7L (7000cc) Diesel or max 10L (10,000CC) Petrol Engines
- Suitable to charge 12V 2.5A / 16V 3.5A or 19V 3.5A Digital Devices
- Suitable to charge 12V DC Devices max 180W 15A when used in conjunction with EC8 to EC5 Adaptor and Female Cigarette Lighter Socket (SSFCL156 sold separately)
- Suitable for use with Tyre Pump (TP001 sold separately)
- Full Recharging recommended after each use and every 6-8 weeks
- Not to be stored in areas of excessive heat where ambient temperature is above 60°C



Zip carry case contents:

- SAA Approved 240V AC / 15V DC 2A Battery Charger
- 12V DC / 15V DC 1A Car Cigarette Lighter Charger
- Heavy Duty Jumper Leads
- EC8 to EC5 Cable Adaptor
- USB 5V 2 in 1 Adaptor Cable
- Multi Volt Digital Charging Cable and 8 Adaptors
- LED flashlight with 3 modes (ON or SOS or EMERGENCY FLASH)
- Backlit LCD Display Screen
- Ultra slim zip carry bag (365x265x70mm Complete Kit Weight 2.3kg)



SJS3000

JSSJL156 Team Brand Products

- **Smart jump start charger**
- **STANDBY:** SOLID RED LED Jumper Leads connected to Power Pack and in SHORT CIRCUIT protection mode
- **BATTERY DETECTION:** SOLID RED LED Jumper clamps connected to battery but vehicle battery has less than 6V. (no output) RECHARGE / REPLACE VEHICLE BATTERY
- **CORRECT CONNECTION:** SOLID GREEN LED Jumper clamps are connected correctly to the vehicle battery terminals. READY TO JUMP START (1min Time Out)
- **INCORRECT CONNECTION:** FAST RED FLASH LED Jumper leads are not connected to the vehicle battery terminals correctly (NO Output)
- **OVER TEMPERATURE:** SLOW GREEN FLASH LED Jumper leads are over heating from continuous cranking or over load. (NO Output) until leads cool down
- **LOW VOLTAGE:** FAST GREEN FLASH LED Power Pack voltage is too low for jump starting attempt. Fully charge the Power Pack. (No Output)
- **VOLTAGE DIFFERENTIAL:** ALTERNATE RED/ GREEN FLASH LED Vehicle Battery voltage is higher than Power Pack. (No Output)
- **REVERSE CURRENT:** ALTERNATE RED/GREEN FLASH LED Vehicle engine has started and is running. (No Output). Disconnect Power Pack from vehicle battery immediately.

Part No.	JSSJL156
Cable	8AWG 200°C
Clamps	Insulated Copper
Forward Current	800A max.
Reverse Current	2A max. 18V max.
Battery Detection	Min.6V
Overheat Cut Out	60°C
Cool Down	Approx.3 min
Reset	Manual button
Time Out	1 min to Red flashing LED



JSSJL156

LEDRESIST

LED Load Resistors 12V 25W 60hm (2PK)

The use of LED tail light bulbs to substitute incandescent bulbs may cause LED bulbs to increase in frequency of flash of the turn indicator, when the turn signal is initiated. To rectify this, you need to mimic the incandescent bulbs current load features. Meeting this load requirement is as simple as attaching one load resistor to each of the lamps.

eXelite



LEDRESIST

LED Auto Globes Team Brand Products



LEDB242

GLOBE LED Auto BAYONET 12V 4W BA9S 6000K (2 PACK)

Wattage	4W
Kelvin	6000K
Lumens	65LM
Warranty	2 Year



LEDB264

GLOBE LED Auto BAYONET 12-24V 21W BA15S 6000K (2 PACK)

Wattage	21W
Kelvin	6000K
Lumens	420LM
Warranty	2 Year



LEDB264FY

GLOBE LED Auto BAYONET 12V 21W BAU15S AMBER 6000K (2 PACK)

Wattage	21W
Kelvin	AMBER
Lumens	360LM
Warranty	2 Year



LEDB265

GLOBE LED Auto BAYONET 12-24V 21/4W BAY15D 6000K (2 PACK)

Wattage	21/5W
Kelvin	6000K
Lumens	380LM (High-beam); 200LM (Low-beam)
Warranty	2 Year



LEDB265D

GLOBE LED Auto BAYONET 12-24V 21/5W BAZ15D 6000K (2 PACK)

Wattage	21/4W
Kelvin	6000K
Lumens	380LM (High-beam); 200LM (Low-beam)
Warranty	2 Year



LEDF271

GLOBE LED Auto FESTOON 12V 10W SV8.5 T11 6000K 36MM (2 PACK)

Wattage	10W
Kelvin	6000K
Lumens	68LM
Warranty	2 Year



LEDF272A

GLOBE LED Auto FESTOON 12V 10W SV8.5 T11 6000K 36MM (2 PACK)

Wattage	10W
Kelvin	6000K
Lumens	68LM
Warranty	2 Year



LEDF274

GLOBE LED Auto FESTOON 12V 10W SV8.5 T11 6000K 36MM (2 PACK)

Wattage	10W
Kelvin	6000K
Lumens	90LM
Warranty	2 Year



LEDW252

GLOBE LED Auto WEDGE 12V W5W T10 6000K (2 PACK)

Wattage	5W
Kelvin	6000K
Lumens	65LM
Warranty	2 Year



LEDW920

GLOBE LED Auto WEDGE 12V W5W T10 6000K (2 PACK)

Wattage	21W
Kelvin	6000K
Lumens	420LM
Warranty	2 Year



LEDW920A

GLOBE LED Auto WEDGE 12-24V 21W T20 6000K AMBER (2 PACK)

Wattage	21W
Kelvin	AMBER
Lumens	360LM
Warranty	2 Year



LEDW921

GLOBE LED Auto WEDGE 12-24V 21W T20 6000K AMBER (2 PACK)

Wattage	16W
Kelvin	6000K
Lumens	350LM
Warranty	2 Year



LEDW922

GLOBE LED Auto WEDGE 12-24V 21W T20 6000K AMBER (2 PACK)

Wattage	21/5W
Kelvin	6000K
Lumens	380LM (high-beam); 200LM (low-beam)
Warranty	2 Year



LEDW3157

GLOBE LED Auto WEDGE 12-24V 21/5W T20 6000K (2 PACK)

Wattage	21/5W
Kelvin	6000K
Lumens	380LM (high-beam); 200LM (low-beam)
Warranty	2 Year



**EXECH4(H4), EXECH7(H7),
EXECHU1(H8, H9, H11, H16),
EXECHU2(9005, 9006), EXEC9012(9012)**

GLOBE LED Auto Easy Connect 9-24V AC 25W (2 PACK)

Wattage	25W
Kelvin	6500K
Lumens	5000LM
Warranty	2 Year

COOPERKLEENJELLY Team Brand Products

- **Detailers jelly (The cleaning gel)**
- Cooper Kleen 'Jelly' Cleaning Gel is the perfect solution for cleaning any surface with hard-to-reach gaps and corners. This product is designed to remove dirt and dust particles and can be safely used on most surfaces including that of electronic devices and appliances. This cleaning gel is ideal for nearly any application in your home, office and car.
- Natural mint fragrance
- Box QTY of 10pcs only

Usage:

- Remove the gel out of the package and knead it several times with dry hands.
- Place the gel on the targeted surface and press it gently on the gaps and crevasses.
- Pull the gel around to remove the dirt and dust. Repeat these steps as many times as needed.



COOPERKLEENJELLY

Easy and efficient.
Cleans hard to reach gaps and corners.



GRABARAG Team Brand Products

- **Multipurpose microfibre automotive cleaning rags**
- Portable pop-up dispenser containing 50 rags, for grab and go cleaning
- New edgeless technology finish: No scratches
- Use wet or dry, with or without chemicals
- Water absorbent 8-9 times its weight
- Pull-use-reuse



GRABARAG

BARRY & BIG FELLA Team Brand Products

- **Synthetic chamois cloth**
- Made in UK
- The very effective and satisfying, first-class quality, perforated synthetic chamois cloth.
- BIG FELLA: 60x50cm; BARRY: 40x45cm
- Wash before first use and wring out excess water
- Begin with drying all windows, followed by other areas of the car. If the chamois is dropped, rinse carefully to remove any impurities
- After each use, rinse chamois with clean water (by hand or machine, without any bleach) to remove dirt particles. Rinse again in clean water and then allow to dry (Machine washable at 95°C)
- Chamois remains soft when dry

Directions:

- Wash before first use and wring out excess water
- Begin with drying all windows, followed by other areas of the car. If the chamois is dropped, rinse carefully to remove any impurities
- After each use, rinse chamois with clean water (by hand or machine, without any bleach) to remove dirt particles. Rinse again in clean water and then allow to dry (Machine washable at 95°C)
- Chamois remains soft when dry

Comprised of the finest material, allowing for outstanding absorbency and a supreme level of resilience, drying your vehicle with a streak free clean finish, in showroom condition!



BIG FELLA

FLUFFY

- **The magnificent automotive drying towel**
- COOPER KLEEN'S very effective, luxurious, soft and absorbent drying towel that leaves your vehicle gleaming!
- 40cm x 70cm
- Fabric density: 1000 GSM
- A splendid blend of 30% polyamide and 70% polyester
- Machine washable in cold or warm water only
- Soft and durable, scratch free edging
- Please note the actual item is yellow on both sides

Directions of Use:

After washing the vehicle, use the Cooper Kleen Drying Towel, starting with drying car windows followed by paintwork on the body of the car (top to bottom). Wring out excess water as necessary to prevent any smearing. Regularly check the towel for any dirt particles that may attach while drying to prevent possible micro-scratching.



FLUFFY

HEADLIGHTRESTKIT Team Brand Products

- **DIY headlight restoration kit**
- Cooper Kleen DIY Headlight Restoration Kit is designed to eliminate the worst cases of headlight degradation, yellowing, oxidation and scratches from your headlights. The kit includes everything needed to restore the cloudiest lenses and can be used without any special tools. Get great results on most plastic lenses, such as tail lights, trailers, boat windows, helmet visors, motorcycle windscreens, snowmobiles and more.
- No special tools required
- Clears headlights lens from haze and contamination
- Quick and easy 3-step process



What's included

- P800 Sanding Disc (2)
- P1200 Sanding Disc (2)
- P2000 Sanding Disc (2)
- UV Protection Liquid 3ml (2)
- Hand Buff Tool (1)
- Wool Polish Disc (1)
- Polish Paste 85gm (1)
- White Sponge Disc (1)
- Masking Tape (1)
- Instruction Manual (1)



HEADLIGHTRESTKIT

WINDSCREENREPKIT

- **DIY windscreen repair kit**
- Cooper Kleen Windscreen Repair Kit is a handy tool designed to make repairing small chips and cracks in your windscreen a breeze in just 30 to 50 minutes. This kit will minimise the appearance of chips and cracks in your windscreen and prevent them from spreading any further. It works by removing air from the break and then fills it with a durable resin, making the area even stronger than before. To achieve the best results, repairs should be done as soon as the damage has occurred and before the break is contaminated by dirt or water.

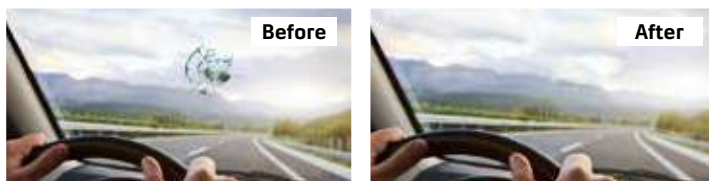

What's included

- Repair Resin (1)
- Pedestal (1)
- Razor Blade (1)
- Cleaning Cloth (1)
- Black O-ring (3)
- Rubber tube (1)
- Adhesive Seal (3)
- Curing Film (5)
- Injector with Spring Clip (1)
- Push Pin (1)
- Reflector (1)
- Instruction Manual (1)



WINDSCREENREPKIT

SENSORHEADLIGHT Team Brand Products

- Ultra bright 5W COB LED headlamp (350LM)
- Brightness control - 3 settings: 50%, 100% & S.O.S.
- Smart on/off handwave sensor
- 45° tilt light for flexible light positioning
- Ultra lightweight design
- Adjustable headband with non-slip grip
- Rechargeable
- Battery level and charge indicator
- Micro USB charging system
- Battery: 3.7v 1400mAH Polymer Li-ion
- Operating time: 3-20 Hours
- USB charging cord included

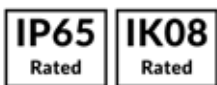

Handwave Sense On/ Off

- Easily turn the headlamp on and off by simply swiping your hand in front of the motion sensor.
- This allows you to quickly turn on the light when you need it and off when you don't.



SENSORHEADLIGHT



45° ADJUSTABLE ANGLE

The light source can be adjusted between 0-45° to meet various conditions of use



LIGHTHOUSE

- Powerful performance rechargeable LED head lamp
- Super bright Cree P50 LED
- Function: Full beam/ Low beam/ Flash
- Wattage: 15W; Lumen: 1000lm
- Telescopic zoom design with a focusing range up to 500m
- Battery level indicator
- Built-in rapid cooling device
- Double aluminium alloy body provides optimal heat dissipation to prevent overheating
- Adjustable angle lighting: 90°
- Working time: up to 4 hours
- Micro USB rechargeable
- Micro USB charger cable included
- Batteries: 3x18650 Lithium batteries (total 6000mAh)
- Charging time: 4-5 hours
- Weight: 239g



eXelite



LIGHTHOUSE

LED3HPHL Team Brand Products

- LED head light
- Wattage: 3W
- Material: ABS
- Brightness: 120lm
- Switch: 2pcs switch
- Battery: 1pc Polymer 1200Mah lithium battery included
- Work time: approx. 4 hours on full function 100% strong light
- IP rating: IP44
- Includes SAA adapter and 1m USB cable in black
- **Function: (1) 100% white light; (2) 50% white light; (3) red light; (4) red light flash**



240V 1m USB
CHARGER INCL.



LED3HPHL

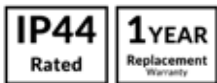

LED10FOXTCH

- LED waterproof torch
- LED chips: CREE LED
- Wattage: 10W
- LED 780 Lumens brightness with 200m range
- 1x18650 Li-ion rechargeable battery
- Product size: 124.5 x 26.5 x 26.5mm
- Weight: 95g
- Aeronautical aluminium alloy
- Battery running time up to 1.5 hours

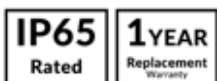

LED10FOXTCH

LED10COUGARTCH

- LED waterproof torch
- LED chips: CREE LED
- Wattage: 10W
- LED 780 Lumens brightness with 500m range
- 1x18650 Li-ion rechargeable battery
- Product size: 186 x 48 x 27mm
- Weight: 195g
- Aeronautical aluminium alloy
- Battery running time up to 1.5 hours

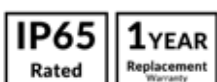

LED10COUGARTCH

BIG SLIM Team Brand Products

eXelite

- LED COB slim worklight & torch
- Dimmable 20-100%
- Rechargeable
- Super strong 360° swivel magnet base & hook
- Robust slim light
- Kelvin: 6500K
- IP67: Dust & water resistant up to 1 meter in depth protection
- IK08: Impact resistant



Worklight (Main COB Light):

- Ultra bright 10W COB LED
- Max.lumen: 800lm

Torch Light:

- 3W LED
- Max.lumen: 200lm

Package Includes:

- 110-240V SAA AC charger
- USB charging cable
- USB car charger

Work Time:

- Using maximum lumen: 2.5 hours
- Using minimum lumen: 20 hours

Battery:

- 3.7V 2500mAh/Li-ion Rechargeable battery
- Charging time: Approx 5 hours
- Charge the battery completely and perform to zero when using for the first time. Then fully charge again. During charging, the indicator light will flash. After charging is complete, it will stop flashing and indicator lights will be on.



SUPER STRONG
MAGNET BASE

BIG SLIM

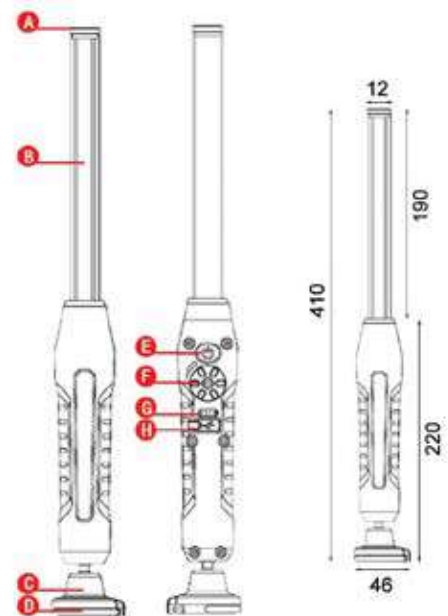

- A. TORCH LIGHT
- B. MAIN COB LIGHT
- C. 360° SWIVEL MAGNET BASE
- D. STRONG SWIVEL HOOK
- E. ON/OFF SWITCH
- F. DIMMING DIAL
- G. LED LAMP BATTERY INDICATOR
- H. MICRO USB CHARGING INPUT



SLIM BENDY Team Brand Products

- 360° Rotational
- Slim and Bendy
- Dimmable (100%-10%)
- Rechargeable
- Strong Magnet at Base
- Metal hook to hang
- 5W COB LED
- Kelvin: 6500K; Lumen: 500LM
- CRI: >80
- Charging time: approximately 5 hours
- Operating time: Min: 2.45hrs on full beam; Max: 20hrs on low beam
- Torch LED on top: 2W 140LM
- Battery: 3.7V, 2500mAh Li-ion rechargeable battery



SLIM BENDY

ROCKY

- Heavy duty housing design/pro level
- Super strong base magnet with adjustable beam angle
- Battery capacity display
- Worklight: 1000 lumen (Dimmable)
- Torch: 200 lumen
- Charging time: Approximately 5.5 hours
- Operating time:
 - Worklight Min: 2.5hrs on 100% lumen
 - Worklight Max: 20hrs on 10% lumen
 - Torch: 12hrs
- Battery: 3.7V, 4400mAh Li-ion rechargeable battery



ROCKY

Worklight:

10W 6500K 1000LM
 LED chip: COB
 CRI: >80
 Dimming range: 100%-10%

Torch:

3W LED 6500K 200LM
 CRI: >80

Box Includes:

110V-240V SAA AC charger
 USB charging cable
 USB car charger

Torch:
 3W, 6500K, 200LM
 Worklight:
 dimmable
 10W, 6500K, 1000LM

Super strong base magnet

Adjustable Beam Angle



GRAB-AND-GO Team Brand Products

- Rechargeable worklight & torch
- 2 heavy duty magnets
- Swivel hook
- Lumen output: 1200LM
- Kelvin: 6500K
- 15W COB LED
- 3.7V, 5000mAh
- Inspection sequence: 10% /50% /100% /Torch off
- SAA USB charger
- USB charging cable
- 90° angle magnet
- Material: aluminium + Polycarbonate + TPE
- IP54 ingress protection
- IK07 impact resistance
- Charging time: Lamp-5hrs; Base-7.5hrs
- Worktime: 3.5hrs (full beam)
- Battery Status indicator
- Charging stand including



GRAB-AND-GO

LED65WKL Team Brand Products

- Rechargeable 6+5 LED angle work light & torch
- Re-chargeable Lithium battery, 3.7V 2200mAh
- 0.3W LED + 6 x 0.5W SMD LED
- Equivalent to approximately 300 lumen
- Operating temperature: -5 to 45°C
- Working time after full charge: Approximately 3.5hr
- Charging time: Approximately 5hr
- The ambient temperature will affect the time of charging and discharging
- AC adapter: 100V-240V input, 5V 1000mA output
- Strong magnetic, adjustable angle work light



LED65WKL

LITTLE KRAKKA Team Brand Products

- 12V emergency torch & work light
- Charged by cigarette lighter plug
- USB car charger adapter
- Charging voltage: 12V
- Output voltage: 5V, 2Amps
- LED chips: XPG (Torch) + COB (Work Light)
- 300 lumen (Torch); 200 lumen (Work light)
- 90° swivel head
- Torch function: Strong light, Low light, Flash light
- Work light function: Strong light
- Battery: 14500 battery, 800mAh
- Working time: up to 2.5 hours
- Include strong magnet on body
- Built in safety hammer
- Sold in 5pcs Merchandise Pack



LITTLEKRAKKA5PK

EXELRIPPA5PK

- LED slim folding rechargeable work light
- LED chips: COB LED + 1PC LED
- 1 x 16340 Lithium Battery, 600mAh
- Maximum output 240 lumen
- Impact resistant 1m
- USB rechargeable
- Pocket clip
- Strong magnet at the bottom
- FUNCTION options: High light/ Low light/ Torch/ Red light/ Red flash
- Product Size: 9.5 x 3.7 x 2.6cm
- Package Weight: 77g
- COB angle adjustable
- Sold in 5pcs Merchandise Pack



EXELRIPPA5PK



Slim light rotates 360° and swivels 180° for adjustable illumination at any angle



USB Charge



Folds for Compact Storage



LED41WKL

- Rechargeable 4+1 LED angle work light & torch
- Re-chargeable Lithium battery
- Will run for approx. 3 hours after a full charge
- Charging time approx. 5.5 hours



eXelite



LED41WKL

TOE2530PRO

- Rechargeable LED work light
- Cordless rechargeable
- 30pcs long life LED chips
- Colour temp: 6400K, lumens: 200lm
- Length: 350mm
- LED chips: 20,000 MCD
- 5 hours use and 5 hours charge time
- Water, oil and shock resistant IP54
- Switch on handle, swivel hanging hook
- 240V charger included
- Lamp will not operate whilst on charge
- Australian Standards Approved



eXelite



TOE2530PRO

EX-288

- LED multi voltage 288pcs LED chips tube light
- 288pcs LED chips
- Wattage: 20W
- 1500 lumens watt efficiency
- Low power consumption 1.5Amp current draw 12V DC
- Includes 6.8m double insulated cable with IP65 joiner plug for 12V to 24V DC use (complete with cigarette plug socket and battery clamp adapter) and SAA approved driver for 240V AC use
- Smart boost design allows for full light output even on a less than fully charged battery to 9V
- 1.2m input cable with waterproof IP65 on/off switch
- Adjustable velcro straps and plastic coated hanging hooks
- Suitable for use in workshops, camping, automobile, outdoors



eXelite



EX-288

EX-10812V (Cigarette Plug) Team Brand Products

- LED tube light
- 12 volt cable, 12V DC
- Wattage: 8 watts, Lumens: 800 lumens
- 108 hi Intensity SMD LEDs
- Switch on handle
- Swivel hanging metal hook
- Metal swivel hook
- Australian/NZ standards approved
- Powerful wide beam
- Cigarette plug with battery adapter

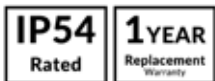

eXelite



EX-10812V

EX-108

- LED 108pcs 3528 LED tube light
- Wattage: 10W; Kelvin: 6700K; Lumens: 800LM
- Input voltage: 110-240V
- CRI: 80
- Twice as bright as similar 11W fluorescent
- Australian Standards Approved wall plug 240V AC driver
- Solid state lighting technology makes for much improved vibration and impact protection over fluorescent work light
- Upgraded plastic coated steel swivel hanging hook with anti-roll handle and 180 degree light beam
- IP54 water and oil resistant
- On/off switch on handle, flex & plug: 8m



eXelite



EX-108

Electrical Terminology

WHAT IS A KELVIN?

The kelvin is often used in the measure of the colour temperature of light sources.

Colour temperature is a characteristic of visible light that has important applications in lighting, photography, publishing, manufacturing, and other fields. The colour temperature of a light source is the temperature of an ideal black-body radiator that radiates light of comparable hue to that of the light source. Colour temperature is conventionally stated in the unit of absolute temperature, the kelvin, having the unit symbol K. Colour temperatures around 6500k are called daylight (stark white) and those around 5000k are called cool colours (natural white), while lower colour temperatures (2700 -3000k) are called warm colours (warm yellow).

Deciding what kelvin to use in your home or office can be a personal choice. Most people prefer day light colours in kitchens and office work areas as this gives the appearance of a brighter white. Many people like to add warmth to their living areas by using a warmer colour. If your areas are separated, you can mix these colours. For those who are undecided, choosing a neutral (cool white colour) is the best option.

WHAT IS A LUMEN?

The lumen is the luminous flux, a measure of the power of light perceived by the human eye. Luminous flux differs from radiant flux in that luminous flux measurements (such as lumens) are intended to reflect the varying sensitivity of the human eye to different wavelengths of light, while radiant flux measurements (such as watts) indicate the total power of light emitted. The lumen is defined in relation to the candela as: $1 \text{ lm} = 1 \text{ cd}\cdot\text{sr}$.

The lumen can be thought of casually as a measure of the total "amount" of visible light in some defined beam or angle, or emitted from some source. The number of candelas or lumens from a source also depends on its spectrum, via the nominal response of the human eye as represented in the luminosity function.

The difference between the units lumen and lux is that the lux takes into account the area over which the luminous flux is spread. A flux of 1000 lumens, concentrated into an area of one square metre, lights up that square metre with an illuminance of 1000 lux. The same 1000 lumens, spread out over ten square metres, produces a dimmer illuminance of only 100 lux. Mathematically, $1 \text{ lx} = 1 \text{ lm}/\text{m}^2$.

A single fluorescent light fixture that produces a luminous flux of 12000 lumens might light a residential kitchen with an illuminance of 500 lux. Lighting a larger area to the same illuminance requires a proportionately greater number of lumens.

Lamps used for lighting are commonly labelled with their light output in lumens.

WHAT IS A LUX?

Not to be confused with a lumen, the lux is the unit of illuminance and luminous emittance measuring luminous power per area.

It is used in photometry as a measure of the intensity, as perceived by the human eye, of light that hits or passes through a surface. It is analogous to the radiometric unit watts per square metre, but with the power at each wavelength weighted according to the luminosity function, a standardized model of human visual brightness perception.

IP Rating

SOLIDS - FIRST DIGIT

The first digit indicates the level of protection that the enclosure provides against hazardous parts and the ingress of solid foreign objects

Level	Object Size Protected Against	Effective Against
0	--	No protection against contact and ingress of objects
1	>50mm	Any large surface of the body, such as the back of a hand, but no protection against deliberate contact with a body part
2	>12.5mm	Fingers or similar objects
3	>2.5mm	Tools, thick wires, etc.
4	>1mm	Most wires, screws, etc.
5	Dust Protected	Ingress of dust is not entirely prevented, but it must not enter in sufficient quantity to interfere with the satisfactory operation of the equipment; complete protection against contact
6	Dust Tight	No ingress of dust; complete protection against contact

LIQUIDS - SECOND DIGIT

Protection of the equipment inside the enclosure against harmful ingress of water.

Level	Protected against	Testing for	Details
0	Not protected	--	--
1	Dripping water	Dripping water (vertically falling drops) shall have no harmful effect.	Test duration: 10 minutes Water equivalent to 3-5mm rainfall per minute
2	Dripping water when tilted up to 15°	Vertically dripping water shall have no harmful effect when the enclosure is tilted at an angle up to 15° from its normal position.	Test duration: 10 minutes Water equivalent to 3-5mm rainfall per minute
3	Spraying water	Water falling as a spray at any angle up to 60° from the vertical shall have no harmful effect.	Test duration: 5 minutes Water Volume: 0.7 litres per minute Pressure: 80-100kNm ²
4	Splashing water	Water splashing against the enclosure from any direction shall have no harmful effect.	Test duration: 5 minutes Water Volume: 10 litres per minute Pressure: 80-100kNm ²
5	Water jets	Water projected by a nozzle (6.3mm) against enclosure from any direction shall have no harmful effects.	Test duration: at least 3 minutes Water volume: 12.5 litres per minute Pressure: 30kN/m ² at distance of 3meters
6	Powerful water jets	Water projected in powerful jets (12.5mm nozzle) against the enclosure from any direction shall have no harmful effects.	Test duration: at least 3 minutes Water volume: 100 litres per minute Pressure: 100kN/m ² at distance of 3meters
7	Immersion up to 1m	Ingress of water in harmful quantity shall not be possible when the enclosure is immersed in water under defined conditions of pressure and time (up to 1m of submersion)	Test duration: 30 minutes Immersion at depth of 1meter
8	Immersion beyond 1m	The equipment is suitable for continuous immersion in water under conditions which shall be specified by the manufacturer. Normally, this will mean that the equipment is hermetically sealed. However, with certain types of equipment, it can mean that water can enter but only in such a manner that produces no harmful effects.	

IK Rating

IK RATINGS

Degree of impact Protection EN62262.

IK rating system is an international classification showing degrees of protection provided by luminaires against external mechanical impacts.

Number	Measure of Protection -impact energy (joules)	Test
IK/00	No protection to this standard	
IK/01	0.15	0.20 kg impact
IK/02	0.20	0.20 kg impact
IK/03	0.35	0.2 kg impact
IK/04	0.50	0.20 kg impact
IK/05	0.70	0.20 kg impact
IK/06	1.00	0.50 kg impact from 200mm
IK/07	2.00	0.50 kg impact from 400mm
IK/08	5.00	1.70 kg impact from 295mm
IK/09	10.00	5.00 kg impact from 200mm
IK/10	20.00	5.00 kg impact from 400mm

When higher impact energy protection is required 50 joules is recommended.

CLA Description Abbreviations Index

ABBREVIATION	EXPLANATION
A/C	Alternating Current
ANOD	Anodised Aluminium
BC	Bayonette Cap Globe Base Type (B22)
BLK	Black
CAN	Globe shape - candle
CFL	Compact Fluorescent (inbuilt ballast)
CIRC	Circular
CLR	Clear
COB	Chip On Board
COM	Commercial Use
CONN	Connectable
COP	Copper
D	Degree (Beam angle of light distribution)
D/ADJ	Double Adjustable
D/L	Recessed downlight fitting
DC	Direct Current
DIMM	Dimmable with recommended control gear
DOM	Domestic use
ES	Edison Screw Globe Base Type (E27)
F&P	Flex & plug
FL	Fluorescent (External Ballast Required)
F/RND	Globe shape - Fancy Round
FR	Frosted
HAL	Halogen
H/HOOD	Heat Hood
LB	Long Body
LED	Dedicated light Emitting Diode
LGE	Large
M/Amp	Milliamp
M/BRACKET(S)	Mounting Bracket(s)

ABBREVIATION	EXPLANATION
MED	Medium
P/C	Polycarbonate
PA	Polyamide
PL	External Ballast required/1U
PLC	External Ballast required/2U
RECD	Recessed
RECT	Rectangular
REFL	Reflector
RGB	Red/Green/Blue(multi)
RND	Round
S/ADJ	Single Adjustable
S/C	Satin Chrome
S/M	Surface Mounted
S/N	Satin Nickel
SBC	Small Bayonette Cap (B15)
SES	Small Edison Screw (E14)
SIL	Silver
SMD	Surface Mounted Diode
SML	Small
SQ	Square
SS304	Stainless Steel 304 Grade
SS316	Stainless Steel 316 Grade
T/F	Transformer (electronic)
TRIPHOS	Triphosphorous
WH	White

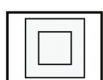

Double insulation



Dimmable

IC (Insulation Contact) Rating for Downlights IC-F (Insulation Contact-Fire Resistant)

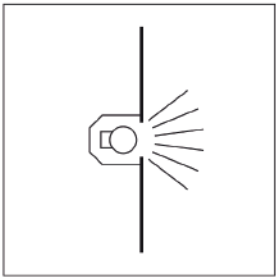
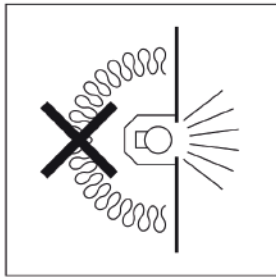
Type	Symbol	Abutted*	Normal use†—Covered	Use with insulation‡	Accessibility to high temperature parts§	Surface of luminaire normal operating temperature limit	Comments
Non-IC		No	No	No	Fully accessible	No limit on side or top surface of luminaire Mounting surface of luminaire limited to 90°C	Suitable for use in Australia and New Zealand—Intended for commercial industrial use only. Not for residential use. Not for use in residential dwellings or other places where building insulation may be installed (now or in the future). These luminaires have not been tested for use with building insulation.
Do-Not-Cover		No	No	Yes	Fully accessible	No limit on side or top surface of luminaire Mounting surface of luminaire limited to 90°C	Currently prohibited from installation in residential locations in New Zealand by AS/NZS 3000. Suitable for residential or commercial use in Australia. Cannot be covered. Manufacturer's stated clearance distances from sides of luminaire to insulation, and clearance above luminaire, will be in the installation instructions supplied with the luminaire, indicating clearances have to be observed at all times for correct installation. These luminaires have been tested to show that they are for use with building insulation present, observing manufacturer's stated installation clearance distances. They cannot be covered with building insulation, however, they have been tested to show that if inadvertently covered they should not become a fire hazard.

(continued)

IC (Insulation Contact) Rating for Downlights IC-F (Insulation Contact-Fire Resistant)

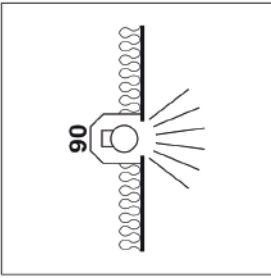
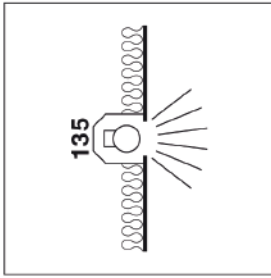
Type	Symbol	Abutted*	Normal use†—Covered	Use with insulation‡	Accessibility to high temperature parts§	Surface of luminaire normal operating temperature limit	Comments
CA90		Yes	No	Yes	Limited access In this Standard, this is assessed for access to high temperature parts by use of a 5.6 mm probe to side and top of luminaire	90°C limit on side or top or mounting surface of luminaire	Suitable for residential or commercial use in Australia and New Zealand. Cannot be covered. Insulation can be placed against the sides of the luminaire. Manufacturer's stated clearance above the luminaire will be in the instructions provided with the luminaire, indicating clearance has to be observed for correct installation. These luminaires have been tested to show that they are for use with building insulation present and placed against the sides of the luminaire. They cannot be covered in building insulation, however, they have been tested to show that if inadvertently covered they should not become a fire hazard.
CA135		Yes	No	Yes	Some access In this Standard, this is assessed for access to high temperature parts by use of a 50 mm probe to side and top of luminaire	135°C limit on side or top surface of luminaire Mounting surface of luminaire limited to 90°C	Suitable for residential or commercial use in New Zealand only. Not permitted for use in Australia. Cannot be covered. Insulation can be placed against the sides of the luminaire. Manufacturer's stated clearance above the luminaire will be in the instructions provided with the luminaire, indicating clearance has to be observed for correct installation. Cannot be used where building materials or insulation is not rated for exposure to constant temperatures of 135°C (cannot have such building material or insulation touching the sides of the luminaire). These luminaires have been tested to show that they are for use with building insulation present and placed against the sides of the luminaire. They cannot be covered in building insulation, however, have been tested to show that if inadvertently covered they should not become a fire hazard.

(continued)

IC (Insulation Contact) Rating for Downlights IC-F (Insulation Contact-Fire Resistant)

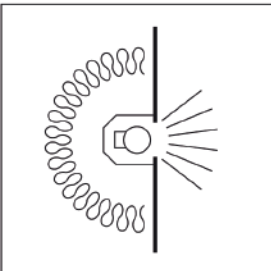
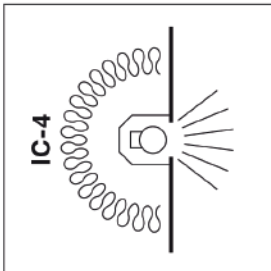
Type	Symbol	Abutted*	Normal use†—Covered	Use with insulation‡	Accessibility to high temperature parts§	Surface of luminaire normal operating temperature limit	Comments
IC		Yes	Yes	Yes	Limited access In this Standard, this is assessed for access to high temperature parts by use of a 5.6 mm probe to sides and top of luminaire.	90°C limit on side or top or mounting surface of luminaire	Suitable for residential or commercial use in Australia and New Zealand. Used where some air transfer is allowed or desired between living space and roof space (there will be some air transfer between the spaces if the luminaire is not fully covered in insulation). These luminaires have been tested to show they are suitable for normal use when covered in building insulation.
IC-4		Yes	Yes	Yes	Restricted access In this Standard, this is assessed for access to high temperature parts by use of a IP4X—1 mm probe to sides, top and front face of luminaire.	90°C limit on side or top or mounting surface of luminaire	Suitable for residential or commercial use in Australia and New Zealand. Used where air transfer is not permitted or not desired between living space and roof space (there will be no air transfer between spaces even if there is no insulation covering the luminaire). Typical use is passive house design where no air transfer is allowed. These luminaires have been tested to show that they are suitable for normal use when covered in building insulation.

(continued)

IC (Insulation Contact) Rating for Downlights IC-F (Insulation Contact-Fire Resistant)

Type	Symbol	Abutted*	Normal use†—Covered	Use with insulation‡	Accessibility to high temperature parts§	Surface of luminaire normal operating temperature limit	Comments
No Marking		No	No	No	No		<p>Not verified as tested/compliant to Australian/New Zealand standards.</p> <p>Marking is required by standards—no marking indicates non-compliance.</p> <p>Installation instructions specifying any clearance distance is required by this Standard.</p> <p>Do not install any luminaire that does not have one of the marking symbols or instructions specifying any clearance distances.</p> <p>NOTE: For luminaires installed prior to the publication of this Standard (AS/NZS 60598.2.2:2016), which do not have marking and/or installation instructions with clearance distances specified, refer to AS/NZS 3000.</p>

* May be abutted against normally flammable building elements or insulation.

† Intended and tested for use under building insulation as part of normal operation.

‡ May be used where building insulation may be installed (now or in the future).

§ Classification and probe to determine access of insulation etc., to high temperature parts.

Index by Part Number

PART NO.	BARCODE	PAGE	PART NO.	BARCODE	PAGE
2D28WGR10QWW	9326191016288	407	BELLA1	9326191034398	75
2D28WGR8DL	9326191019814	407	BELLA2	9326191034404	75
3U001	9326191025938	399	BELLA3	9326191034411	75
3U002	9326191025945	399	BES1	9326191027628	225
3U003	9326191025952	399	BES2	9326191027635	225
A			BIG FELLA	9323129057399	453
ABBEY1	9326191030093	87	BIG SLIM	9323129084838	457
ABBEY2	9326191030109	87	BLACKBAND1	9326191018152	142
AKEN1	9326191029301	217	BLACKBAND1X3	9326191019982	144
AKEN2	9326191029318	217	BLACKBAND2	9326191018169	142
ALTA1	9326191023880	148	BLACKBAND2X3	9326191019999	144
ALTA1W	9326191025372	175	BLACKBAND3	9326191018176	142
ALTA2	9326191023897	148	BLACKBAND4	9326191018183	142
ALTA2W	9326191025389	175	BLACKBAND5	9326191019968	143
ALTA3	9326191023903	148	BLACKBAND6	9326191019975	143
ALTA3W	9326191025396	175	BOCINA01	9326191032479	212
AMUN1	9326191024740	283	BOCINA02	9326191032653	212
AMUN2	9326191024757	283	BOL1A	9326191030963	288
AMUN3	9326191024764	283	BOL2A	9326191030970	288
AMUN4	9326191024771	283	BOL3A	9326191030987	288
APIS1	9326191027697	218	BOL4A	9326191030994	288
APIS2	9326191027703	218	BONITO1	9326191019630	99
ARMIS1	9326191027475	117	BONITO2	9326191019647	99
ARMIS2	9326191027482	117	BONITO3	9326191019654	99
ARMIS3	9326191027499	117	BONITO6	9326191029998	99
ARMIS4	9326191027505	117	BONITO7	9326191030000	99
ARMIS5	9326191027512	117	BONITO8	9326191030017	99
ARMIS6	9326191027529	117	BORDA1	9326191036095	276
ARMIS7	9326191027536	117	BORDA2	9326191036101	276
ARMIS8	9326191027543	117	BORDA3	9326191036118	276
ARMIS9	9326191027550	117	BORDA4	9326191036125	276
ATEN1	9326191024887	219	BORDA5	9326191036132	276
ATEN2	9326191024894	219	BORDA6	9326191036149	276
ATHENSG2	9326191029509	180	BOTANICA01	9326191032394	52
AUTUMN01	9326191029028	103	BOTANICA02	9326191032400	52
AUTUMN02	9326191029035	103	BOTANICA03	9326191032417	52
AUTUMN03W	9326191029042	178	BRICK0001	9326191025549	232
AUTUMN04TL	9326191029059	169	BRICK0002	9326191025556	232
B			BRICK0003	9326191025563	232
BANQUET1	9326191036927	29	BRICK0004	9326191025570	232
BARCELONA	9326191014475	180	BRIGHTON01	9326191029622	188
BARRIQUE1	9326191036903	26	BRIGHTON02	9326191029639	188
BARRIQUE2	9326191036910	26	BROTE1	9326191034930	36
BARROSA	9326191018879	129	BROTE2	9326191034947	36
BARRY	9323129057382	453	BUG003	9326191010712	398
BATFIX01	9326191032127	440	BUG004	9326191010705	398

Index by Part Number

PART NO.	BARCODE	PAGE	PART NO.	BARCODE	PAGE
BULK1	9326191015793	234	CAN5	9326191015922	383
BULK10	9326191025242	236	CAN5D	9326191017018	385
BULK11	9326191026706	237	CAN6	9326191015939	383
BULK12	9326191026713	237	CAN6D	9326191017025	385
BULK13	9326191026683	237	CAN7D	9326191017032	385
BULK14	9326191026690	237	CAN8	9326191015953	383
BULK15	9326191029455	238	CAN8D	9326191017049	385
BULK16	9326191029448	238	CAN9	9326191016486	383
BULK17	9326191029479	238	CAN9D	9326191017056	385
BULK18	9326191029462	238	CANAMO1	9326191035890	41
BULK2	9326191015809	234	CANAMO2	9326191035906	41
BULK3	9326191015816	235	CANASTA1	9326191035821	45
BULK5	9326191022203	235	CANASTA2	9326191035838	45
BULK7	9326191024320	235	CANNES	9326191015373	181
BULK9	9326191025235	236	CASA1	9326191018893	130
C			CASA2	9326191018909	130
CAN10	9326191016493	383	CASA3	9326191018916	130
CAN10D	9326191017063	385	CAVIAR4	9326191028212	153
CAN11D	9326191017070	385	CAVIAR5	9326191028229	153
CAN13	9326191016608	383	CAVIAR6	9326191028236	153
CAN13D	9326191017094	385	CELESTE1	9326191024085	119
CAN14D	9326191017100	385	CELESTE2	9326191024092	119
CAN15D	9326191017117	385	CELESTE3	9326191024108	119
CAN16	9326191016639	383	CEREMA1	9326191035784	46
CAN16D	9326191017124	385	CEREMA2	9326191035791	46
CAN17	9326191018947	382	CEREMA3	9326191035807	46
CAN18	9326191018954	382	CEREMA4	9326191035814	46
CAN1D	9326191016974	385	CESTA1	9326191035883	44
CAN20	9326191018978	382	CF14DIM	9326191030321	375
CAN24	9326191019012	382	CF15DIM	9326191030338	375
CAN25	9326191023637	384	CF16DIM	9326191030345	375
CAN28A	9326191031823	384	CF17DIM	9326191030352	375
CAN29	9326191023675	384	CF18DIM	9326191030369	387
CAN2D	9326191016981	385	CF19DIM	9326191030376	387
CAN32A	9326191032257	384	CF20DIM	9326191030383	387
CAN33D	9326191035425	382	CF21DIM	9326191030390	387
CAN34D	9326191035432	382	CF22DIM	9326191030406	389
CAN35D	9326191035449	382	CF23DIM	9326191030413	389
CAN36D	9326191035456	382	CF24DIM	9326191030420	389
CAN37D	9326191035463	382	CF25DIM	9326191030437	389
CAN38D	9326191035470	382	CF26DIM	9326191030444	392
CAN39D	9326191035487	382	CF27DIM	9326191030451	392
CAN3D	9326191016998	385	CF28DIM	9326191030468	392
CAN4	9326191015540	383	CF29DIM	9326191030475	392
CAN40D	9326191035494	382	CF30DIM	9326191030482	378
CAN4D	9326191017001	385	CF31DIM	9326191030499	378

Index by Part Number

PART NO.	BARCODE	PAGE	PART NO.	BARCODE	PAGE
CF32DIM	9326191030505	378	CIOTOLA6	9326191033209	67
CF33DIM	9326191030512	378	CKTRIO1	9326191031786	405
CF34DIM	9326191030529	378	CKTRIO2	9326191031793	405
CF35DIM	9326191030536	378	CKTRIO3	9326191031809	405
CF36DIM	9326191030543	378	CLA111011	9326191011993	423
CF37DIM	9326191030550	378	CLA1120011	9326191014147	423
CF38DIM	9326191030567	381	CLA113011	9326191012006	423
CF39DIM	9326191030574	381	CLA1615L	9326191014758	275
CF3A	9326191021107	390	CLA1615LBL	9326191029431	275
CF40DIM	9326191030581	381	CLA1615S	9326191014741	275
CF41DIM	9326191030598	381	CLA1615SBL	9326191029424	275
CF42DIM	9326191030604	381	CLA4736CB	9326191032950	239
CF43DIM	9326191030611	381	CLA4PB	9326191014017	443
CF44DIM	9326191030628	381	CLA6PB	9326191014024	443
CF45DIM	9326191030635	381	CLACFA25BC	9326191015731	411
CF46DIM	9326191036279	395	CLACFA25ES	9326191015748	411
CF47DIM	9326191036286	395	CLACFB25BC	9326191015830	411
CF4A	9326191021114	390	CLACFB25ES	9326191015847	411
CF5A	9326191021121	392	CLACFC25BC	9326191015755	412
CF6A	9326191021138	392	CLACFC25ES	9326191015762	412
CHAMA001	9326191026164	398	CLACFD25BC	9326191017148	412
CHAMA002	9326191028281	398	CLACFD25ES	9326191017131	412
CHAMPAN1	9326191034695	61	CLACFE25BC	9326191017162	413
CHAMPAN1X3R	9326191034718	61	CLACFE25ES	9326191017155	413
CHAMPAN1X3S	9326191034701	61	CLACFF25BC	9326191017698	413
CHAMPAN2	9326191034725	61	CLACFF25ES	9326191017704	413
CHAMPAN2X3R	9326191034749	61	CLADR12WFP	9326191012686	424
CHAMPAN2X3S	9326191034732	61	CLAFCL22WCW	9326191007828	408
CHAPEAU1	9326191033032	80	CLAFCL22WDL	9326191007835	408
CHAPEAU2	9326191033049	80	CLAFCL22WNW	9326191009297	408
CHAPEAU3	9326191033056	80	CLAFCL22WWW	9326191007804	408
CHAPEAU4	9326191033063	80	CLAFCL32WCW	9326191007859	408
CHESTER01	9326191029646	189	CLAFCL32WDL	9326191007866	408
CHESTER02	9326191029653	189	CLAFCL32WNW	9326191009303	408
CHEVEUX1	9326191018817	139	CLAFCL40WCW	9326191007880	408
CHEVEUX2	9326191018824	139	CLAFCL40WNW	9326191009310	408
CHEVEUX3	9326191018923	139	CLAFCL40WWW	9326191007873	408
CHEVEUX4	9326191018930	139	CLAHL150W	9326191006173	415
CHUVA1	9326191025341	127	CLAHL275W	9326191003950	415
CHUVA2	9326191025358	127	CLAMCD150W4K	9326191009129	418
CHUVA3	9326191025365	127	CLAMCP3035W10D3K	9326191009242	418
CIOTOLA1	9326191033155	67	CLAMHD150W3000K	9326191001338	417
CIOTOLA2	9326191033162	67	CLAMHD35W3000K	9326191005695	417
CIOTOLA3	9326191033179	67	CLAMHD35W5000K	9326191005718	417
CIOTOLA4	9326191033186	67	CLAMHS150W5000K	9326191001383	417
CIOTOLA5	9326191033193	67	CLAMHS35W4000K	9326191005732	417

Index by Part Number

PART NO.	BARCODE	PAGE	PART NO.	BARCODE	PAGE
CLAMHS35W5000K	9326191005749	417	DIABLO1	9326191037009	34
CLAMHS70W3000K	9326191001352	417	DIABLO2	9326191037016	34
CLASSIC1A	9326191031854	154	DIMERIS	9326191027567	428
CLASSIC2A	9326191031861	154	DIVO1	9326191016066	151
CLAT514WNW	9326191009280	408	DIVO10	9326191034015	151
CLAT514WWW	9326191000751	408	DIVO2	9326191016073	151
CLAT532WWW	9326191010385	407	DIVO3	9326191016080	151
CLAW32	9326191014734	275	DIVO4	9326191016097	151
CLEO1	9326191033353	77	DIVO5	9326191016103	151
CLUSTER1	9326191031083	157	DIVO6	9326191016110	151
CLUSTER2	9326191031090	157	DIVO7	9326191016127	151
CLUSTER3	9326191031106	157	DIVO8	9326191016134	151
CLUSTER4	9326191031113	157	DIVO9	9326191016141	151
COMET01	9326191030147	309	DIYBAT01	9326191031243	192
COMET02	9326191030154	309	DIYBAT02	9326191031250	192
COMET03	9326191030161	309	DIYBAT03	9326191031267	192
COMET04	9326191030178	309	DIYBAT04	9326191031274	192
COMET05	9326191035043	310	DIYBAT05	9326191031281	193
COMET06	9326191035050	310	DIYBAT06	9326191031298	193
COMET07	9326191036941	310	DIYBAT07	9326191031304	193
COMET08	9326191036958	310	DIYBAT08	9326191031311	193
CONN001	9326191025983	436	DIYBAT09	9326191031328	194
CONN002	9326191025990	436	DIYBAT10	9326191031335	194
CONN003	9326191026287	437	DIYBAT11	9326191031342	194
CONN004	9326191026294	437	DIYBAT12	9326191031359	194
CONTOUR1	9326191032981	81	DIYBAT13	9326191031366	195
CONTOUR2	9326191032998	81	DIYBAT14	9326191031373	195
CONTOUR3	9326191033001	81	DIYBAT15	9326191031380	195
COOLIE01	9326191029257	291	DIYBAT16	9326191031397	195
COOLIE02	9326191032332	291	DIYBAT17	9326191031403	196
COOPERKLEENJELLY	9323129058013	452	DIYBAT18	9326191031410	196
CORAZON1	9326191033308	84	DIYBAT19	9326191031427	196
CORAZON2	9326191033315	84	DIYBAT20	9326191031434	196
COSMOTRIO3	9326191037252	312	DIYBATC01	9326191031182	197
COSMOTRIO4	9326191037269	312	DIYBATC02	9326191031199	197
COUP1	9326191035975	42	DIYBATC03	9326191031205	197
D			DIYBATC04	9326191031212	197
DAVOS	9326191025044	181	DIYBATC05	9326191031229	197
DECK01	9326191032059	294	DIYBATC06	9326191031236	197
DECK02	9326191032066	294	DOCCIA1	9326191011504	241
DECK03	9326191032073	294	DOCCIA2	9326191011498	241
DECK04	9326191032080	294	DRIV1	9326191016790	424
DEKSEL01	9326191029912	204	DU10WG24D1CW	9326191020285	409
DEKSEL02	9326191029929	178	DU10WG24D1WW	9327168003120	409
DEKSEL03	9326191029936	152	DU13WG24D1WW	9327168003151	409
DELHI	9326191028557	181	DU18WG24D2WW	9326191017551	409

Index by Part Number

PART NO.	BARCODE	PAGE	PART NO.	BARCODE	PAGE
DUBAIG2	9326191027352	182	FOKUS02	9326191011634	165
DUE18WG24D2CW	9326191031533	409	FOKUS03	9326191011610	165
DUE18WG24D2WW	9326191031540	409	FOKUS04	9326191011603	165
DUE26WWW4PIN	9326191018350	409	FOSSETTE1	9326191034428	72
E			FOSSETTE2	9326191034435	72
ELLIP01	9326191010675	403	FOSSETTE3	9326191034442	72
ELLIP02	9326191010668	403	FOSSETTE4	9326191034459	72
ELLIP03	9326191010651	403	FP1.2M2W	9326191014031	441
ELLIP04	9326191010248	403	FP2M2W	9326191013614	441
ESCAMA1	9326191034985	76	FP2M2WWH	9326191030697	441
ESCAMA2	9326191034992	76	FP2M3W	9326191013621	441
ESPEJO1	9326191034572	69	FP2M3WWH	9326191030703	441
ESPEJO1X3R	9326191034596	69	FP2WSB	9326191031472	441
ESPEJO1X3S	9326191034589	69	FP2WSW	9326191031489	441
ESPEJO2	9326191034602	69	FP3M2WWH	9326191030710	441
ESPEJO2X3R	9326191034626	69	FP3M3WWH	9326191030727	441
ESPEJO2X3S	9326191034619	69	FR1	9326191015557	380
ESPEJO3	9326191034633	71	FR10	9326191016530	380
ESPEJO3X3R	9326191034657	71	FR11	9326191016547	380
ESPEJO3X3S	9326191034640	71	FR12	9326191016554	380
ESPEJO4	9326191034664	71	FR13	9326191016646	380
ESPEJO4X3R	9326191034688	71	FR15	9326191016660	380
ESPEJO4X3S	9326191034671	71	FR16	9326191016677	380
ETH50.302VA	9327168095060	425	FR3	9326191015571	380
EX-108	9325574005604	462	FR36	9326191015854	379
EX-10812V	9326191031557	462	FR37	9326191014802	379
EX-288	9325574005574	461	FR4	9326191015588	380
EXEC9012	9323129092314	451	FR40	9326191014772	379
EXECH4	9323129092284	451	FR41D	9326191035340	379
EXECH7	9323129092291	451	FR42D	9326191035357	379
EXECHU1	9323129092307	451	FR43D	9326191035364	379
EXECHU2	9323129092512	451	FR44D	9326191035371	379
EXELRIPPA5PK	9323129057665	460	FR45D	9326191035388	379
F			FR46D	9326191035395	379
FARO1	9326191023187	111	FR47D	9326191035401	379
FARO2	9326191023194	111	FR48D	9326191035418	379
FINN1	9326191020179	109	FR5	9326191015960	380
FINN2	9326191020186	109	FR6	9326191015977	380
FINN3	9326191020193	109	FR7	9326191015984	380
FIREFLY01A	9326191036651	308	FR8	9326191015991	380
FLOOD14	9326191023309	301	FUMOSO1	9326191024023	131
FLOOD15	9326191027741	300	FUMOSO2	9326191024030	131
FLOOD16	9326191027758	300	FUMOSO3	9326191024047	131
FLOOD22	9326191010958	301	G		
FLUFFY	9323129057900	453	G1251	9326191015618	391
FOKUS01	9326191011818	165	G12510	9326191036163	390

Index by Part Number

PART NO.	BARCODE	PAGE	PART NO.	BARCODE	PAGE
G12511	9326191036170	390	GLS11DB	9326191029493	377
G12512	9326191036187	390	GLS12DB	9326191025723	377
G1252	9326191015625	391	GLS13B	9326191023460	376
G1253	9326191016028	391	GLS14B	9326191023477	376
G1254	9326191016035	391	GLS15B	9326191023484	376
G1257	9326191016707	391	GLS16B	9326191024702	376
G1258	9326191016714	391	GLS21B	9326191027321	376
G1259	9326191036156	390	GLS22B	9326191028106	376
G401	9326191036293	400	GLS23B	9326191024719	376
G403	9326191036880	400	GLS24B	9326191024597	376
G90001	9326191023835	401	GLS25B	9326191027338	376
G90002	9326191023842	401	GLS26B	9326191028090	376
G9510	9326191036200	388	GLS27B	9326191028113	376
G9511	9326191036217	388	GLS28B	9326191024603	376
G9512	9326191036224	388	GLS29D	9326191025716	377
G953	9326191016004	388	GLS30D	9326191025709	377
G954	9326191016011	388	GLS31	9326191027284	376
G956	9326191016578	389	GLS32	9326191027291	376
G957	9326191016684	389	GLS33	9326191027307	376
G958	9326191016691	389	GLS34	9326191027314	376
G959	9326191036194	388	GLS36D	9326191036231	375
GALTRIO1A	9326191036644	311	GLS37D	9326191036248	375
GALTRIO2A	9326191036620	311	GLS38D	9326191036255	375
GALTRIO4	9326191032707	311	GLS39D	9326191036262	375
GALTRIO5	9326191032714	311	GLS9DB	9326191024726	377
GAMBA1	9326191023316	135	GLSTRIBC1	9326191036538	374
GAMBA2	9326191023323	135	GLSTRIES1	9326191036545	374
GAMBA3	9326191024986	135	GOLDA1	9326191033285	83
GAMBA4	9326191024993	135	GOLDA2	9326191033292	83
GEB1	9326191027666	282	GOLPE1	9326191035845	39
GEB2	9326191027673	282	GOLPE2	9326191035869	39
GEB3	9326191027680	282	GOLPE3	9326191035852	39
GENEVA	9326191015366	182	GOLPE4	9326191035876	39
GIRO01	9326191032455	213	GPO01	9326191025518	440
GIRO02	9326191032639	213	GPO02	9326191025495	440
GLANS01	9326191030925	216	GRAB-AND-GO	9323129096435	459
GLANS02	9326191030932	216	GRABARAG	9326191010989	452
GLANS03	9326191030949	216	GU1001	9326191027260	368
GLANS04	9326191030956	216	GU1002	9326191027277	368
GLAZE1	9326191019593	122	GU1003D	9326191034268	369
GLAZE10	9326191031014	123	GU1004D	9326191034275	369
GLAZE11	9326191031021	123	GU10B01A	9326191036606	369
GLAZE2	9326191019609	122	GU10G01A	9326191036590	369
GLAZE3	9326191019616	122	GU10R01A	9326191036583	369
GLAZE5	9326191026171	122	GU10TRI1	9326191036514	368
GLS10DB	9326191024689	377	GX53001	9326191024467	399

Index by Part Number

PART NO.	BARCODE	PAGE
GX53002	9326191024474	399
H		
HATHOR1	9326191029349	284
HATHOR2	9326191029325	284
HATHOR3	9326191029332	284
HEADLIGHTRESTKIT	9323129058020	454
HEKA1	9326191029288	222
HEKA2	9326191029295	222
HEXA1	9326191030055	89
HEXA2	9326191030062	89
HEXADE1	9326191030079	88
HEXADE2	9326191030086	88
HIB12	9326191030758	362
HIB13	9326191030765	362
HINK1	9326191024924	207
HINK2	9326191024931	207
HOPI01	9326191029097	96
HORTEN1	9326191023941	108
HORTEN2	9326191023958	108
HORUS1	9326191024788	286
HORUS2	9326191024795	286
HORUS3	9326191024801	286
HORUS4	9326191024818	286
I		
IDA1	9326191033322	82
IDA2	9326191033339	82
IGGLSQSS	9326191029974	295
IGGLSS	9326191029967	295
IGM1SS	9326191026492	297
IGM2SS	9326191026508	297
IGM3SS	9326191026515	297
IGM4SS	9326191026522	297
IGMEYEC	9326191026553	298
IGMEYESS	9326191026546	298
IGMGRSS	9326191026539	298
IGMLBR	9326191026607	296
IGMLC	9326191026621	296
IGMLSQBR	9326191026614	296
IGMLSQC	9326191026638	296
IGMLSQSS	9326191026591	296
IGMLSS	9326191026584	296
IGMSMC	9326191026560	298
IGMSMSS	9326191026577	298
J		
JEREZ1	9326191034756	59
JEREZ1X3R	9326191034770	59

PART NO.	BARCODE	PAGE
JEREZ1X3S	9326191034763	59
JSSJL156	9325574006151	448
JEREZ2	9326191034787	59
JEREZ2X3R	9326191034800	59
JEREZ2X3S	9326191034794	59
K		
KAM01	9326191030871	292
KHALEESI1	9326191020759	100
KHALEESI2	9326191020766	100
KHALEESI3	9326191020773	100
KOLEC1	9326191036859	292
KOPER1	9326191023200	120
KOPER2	9326191023217	120
KOPER3	9326191023224	120
KUK1	9326191027642	221
KUK2	9326191027659	221
L		
LAMINA1	9326191024054	132
LAMINA3	9326191024078	132
LAMINA4	9326191036897	132
LANTERNA1	9326191023163	110
LANTERNA2	9326191023170	110
LEADB001	9326191028434	442
LEADB002	9326191028441	442
LEADB003	9326191028458	442
LEADB004	9326191028465	442
LEADB005	9326191028472	442
LEADB006	9326191028489	442
LEADB007	9326191028496	442
LEADB008	9326191028502	442
LEADB009	9326191028519	442
LEADW001	9326191028380	442
LEADW002	9326191028397	442
LEADW003	9326191028403	442
LEADW004	9326191028410	442
LEADW005	9326191028427	442
LED10COUGARTCH	9323129054398	456
LED10FOXTCH	9323129054381	456
LED3HPHL	9325574005314	456
LED41WKL	9323129052974	461
LED65WKL	9323129052967	459
LEDB242	9323129058495	449
LEDB264	9323129058587	449
LEDB264FY	9323129058501	449
LEDB265	9323129058594	449
LEDB265D	9323129058600	449

Index by Part Number

PART NO.	BARCODE	PAGE	PART NO.	BARCODE	PAGE
LEDF271	9323129058525	450	LT40D04	9326191023545	387
LEDF272A	9323129058518	450	LT40D05	9326191023521	387
LEDF274	9323129058532	450	LT40D07	9326191023491	387
LEDRESIST	9323129058624	448	LT40D08	9326191023408	387
LEDW252	9323129058488	450	LYON	9326191026010	187
LEDW3157	9323129058617	451	M		
LEDW920	9323129058556	450	MAGNUM1	9326191019722	206
LEDW920A	9323129058563	451	MAGNUM2	9326191019715	206
LEDW921	9323129058549	451	MANU1	9326191036989	35
LEDW922	9323129058570	451	MANU2	9326191036996	35
LEGNA1	9326191025402	118	MARACA1	9326191036453	32
LEGNA2	9326191025419	118	MARACA2	9326191036460	32
LEGNA3	9326191025426	118	MARACA3	9326191036477	32
LEGNA4	9326191025433	118	MARACA4	9326191036484	32
LH0.4M	9326191604058	441	MARACA5	9326191036491	32
LH1.5M	9326191031496	441	MARBRE1	9326191037023	33
LIGHTHOUSE	9323129086559	455	MARBRE2	9326191037030	33
LIGNA01	9326191029127	113	MARBRE3	9326191037047	33
LIGNA02	9326191029134	113	MARINA1	9326191011481	220
LIGNA03	9326191029141	113	MARINA2	9326191011474	220
LIGNA04	9326191029158	113	MARRAKESH01	9326191032349	53
LIGNA05	9326191029165	113	MARRAKESH02	9326191032356	53
LIGNA06	9326191029172	113	MARRAKESH03A	9326191037283	53
LIGNA07	9326191029189	113	MARRAKESH04	9326191032370	53
LIGNA08	9326191029196	113	MARRAKESH05	9326191032387	53
LIGNA09	9326191029202	113	MARTE1	9326191034954	73
LINKTRIO1	9326191031991	359	MARTE2	9326191034961	73
LINKTRIO2	9326191032004	359	MARTE3	9326191034978	73
LINKTRIO3	9326191032011	359	MASON1	9326191018589	126
LINKTRICN	9326191032042	359	MASON2	9326191018596	126
LINKTRIFP	9326191032035	359	MASON3	9326191018602	126
LITTLE KRAKKA	9323129086665	460	MASON4	9326191018619	126
LONDON	9326191013331	182	MASON5	9326191018626	126
LOTUS1	9326191020940	164	MASON6	9326191018633	126
LOTUS2	9326191020957	164	MASON7	9326191018640	126
LT4010	9326191024511	386	MASON8	9326191018657	126
LT4011	9326191024504	386	MASON9	9326191018664	126
LT4012	9326191024344	386	MATRIX-B	9326191020049	141
LT4013	9326191024207	386	MATRIX-W	9326191020056	141
LT4014	9326191024191	386	MAZZA	9326191025471	95
LT4015	9326191024184	386	METEORA1	9326191025488	85
LT4016	9326191024177	386	METIO1	9326191029066	97
LT4017	9326191024160	386	METIO2	9326191029073	97
LT40D01	9326191023576	387	METIO3W	9326191029080	179
LT40D02	9326191023569	387	MIDO01	9326191031885	210
LT40D03	9326191023552	387	MIKRO1	9326191037061	37

Index by Part Number

PART NO.	BARCODE	PAGE	PART NO.	BARCODE	PAGE
MIKRO2	9326191037078	37	ORBITA1	9326191025464	92
MILAN	9326191025006	183	ORBITA2	9326191025457	92
MODELLO1	9326191024009	121	ORBITA3	9326191029387	93
MODELLO2	9326191024016	121	ORBITA4	9326191029394	93
MOOD	9326191025310	170	ORBITA5	9326191029400	93
MOTION1	9326191024399	314	ORDITO1	9326191023354	125
MOTION2	9326191024405	314	ORDITO2	9326191023361	125
MOTION3	9326191024412	314	ORDITO3	9326191023378	125
MOTION4	9326191024429	314	ORIGAMI1	9326191035289	49
MR1101	9326191034558	372	ORIGAMI2	9326191035296	49
MR1102	9326191034565	372	ORIGAMI3	9326191035302	49
MR1601A	9326191010699	370	ORIGAMI4	9326191035319	49
MR1602A	9326191010682	370	ORIGAMI5	9326191035326	49
MR16B01A	9326191036576	371	ORIGAMI6	9326191035333	49
MR16G01A	9326191036569	371	OTTER1	9326191016806	422
MR16R01A	9326191036552	371	OTTER24V1	9326191022517	423
MR16TRI1	9326191036521	370	OTTER24V2	9326191022487	423
N			OTTER24V3	9326191022494	423
NARVIK1	9326191023910	149	OTTER24V4	9326191022500	423
NARVIK2	9326191023927	149	OTTER3	9326191035999	422
NARVIK3	9326191023934	149	OTTER4	9326191036002	422
NED01	9326191029219	231	OTTER5	9326191036019	422
NED02	9326191029226	231	OTTER7	9326191036637	422
NEW YORKG2	9326191032974	183	OYSDIM001	9326191028328	242
NIGHT01	9326191014079	360	OYSDIM002	9326191028335	242
NORDIC1	9326191017810	105	OYSDIM003	9326191010934	328
NORDIC2	9326191017827	105	OYSDIM004	9326191010927	328
NORDIC3	9326191017834	105	OYSDIM005	9326191010910	328
NORDIC4	9326191017841	105	P		
NORDIC5	9326191017858	105	PAPILLON1	9326191033070	79
NORDIC6	9326191017865	105	PAPILLON2	9326191033087	79
NOVACOB01	9326191032943	305	PAR3001	9326191030116	393
NOVADBLK	9326191032271	305	PARIS	9326191013355	183
NOVADBLK01A	9326191037214	306	PASTEL01A	9326191036316	146
NOVADBLK02	9326191033223	307	PASTEL02A	9326191036323	146
NOVADBR	9326191032288	305	PASTEL03A	9326191036330	146
NOVADBR01A	9326191037221	306	PASTEL04A	9326191036347	146
NOVADBR02	9326191033230	307	PASTEL05A	9326191036354	146
NOVADLUX01A	9326191037207	306	PASTEL06A	9326191036361	146
NOVADLUX02	9326191033216	307	PASTEL07A	9326191036378	146
NOVATRIS	9326191034503	313	PASTEL08A	9326191036385	147
O			PASTEL09A	9326191036392	147
OGA01	9326191030901	233	PASTEL10A	9326191036408	147
OGA02	9326191030918	233	PASTEL11A	9326191036415	147
OLA01	9326191032448	214	PASTEL12A	9326191036422	147
OLA02	9326191032622	214	PASTEL13A	9326191036439	147

Index by Part Number

PART NO.	BARCODE	PAGE	PART NO.	BARCODE	PAGE
PASTEL14A	9326191036446	147	PESINI5W	9326191035142	172
PASTEL15TL	9326191027901	166	PESINI6	9326191035210	55
PASTEL16TL	9326191027918	166	PESINI6W	9326191035159	172
PASTEL17TL	9326191027925	166	PG1ABL	9326191026874	256
PASTEL18TL	9326191027932	166	PG1ABR	9326191030246	255
PASTEL19TL	9326191027949	166	PG1AC	9326191026843	252
PASTEL20TL	9326191027956	166	PG1ACEC	9326191027086	253
PASTEL21TL	9326191027963	166	PG1ACECA	9326191029837	254
PASTEL22FL	9326191027970	167	PG1ASHSIL	9326191028151	264
PASTEL23FL	9326191027987	167	PG1ASIL	9326191026898	263
PASTEL24FL	9326191027994	167	PG1ASS	9326191026850	262
PASTEL25FL	9326191028007	167	PG1AT	9326191026867	260
PASTEL26FL	9326191028014	167	PG1AWH	9326191026881	258
PASTEL27FL	9326191028021	167	PG1FBL	9326191026812	256
PASTEL28FL	9326191028038	167	PG1FBR	9326191030222	255
PASTILLE1	9326191033018	78	PG1FC	9326191026782	252
PASTILLE2	9326191033025	78	PG1FCEC	9326191027109	253
PATERA1	9326191035227	54	PG1FCECA	9326191029851	254
PATERA2	9326191035234	54	PG1FSHSIL	9326191028144	264
PATERA3	9326191035241	54	PG1FSIL	9326191026836	263
PDL1SQBL	9326191029271	250	PG1FSS	9326191026799	262
PDL1SQBRZ	9326191028175	250	PG1FT	9326191026805	260
PDL1SQSS	9326191028199	250	PG1FWH	9326191026829	258
PDLUDRECTBLK	9326191032660	250	PG2ABL	9326191026935	256
PDLUDRECTBRZ	9326191028182	250	PG2ABR	9326191030208	255
PDLUDRECTSS	9326191028205	250	PG2AC	9326191026904	252
PELOTA1	9326191037146	31	PG2ACEC	9326191027147	253
PELOTA2	9326191037153	31	PG2ACECA	9326191029899	254
PELOTA3	9326191037160	31	PG2ASHSIL	9326191028168	264
PELOTA4	9326191037177	31	PG2ASIL	9326191026959	263
PELOTA5	9326191037184	31	PG2ASS	9326191026911	262
PELOTA6	9326191037191	31	PG2AT	9326191026928	260
PEN2	9326191016202	156	PG2AWH	9326191026942	258
PEN3	9326191016219	156	PG2BARBL	9326191026997	257
PENDOLO1	9326191029356	102	PG2BART	9326191026966	261
PENDOLO2	9326191029363	102	PG2BARWH	9326191029677	259
PENOLA	9326191018855	129	PG3BARBL	9326191027000	257
PESINI1	9326191035166	55	PG3BART	9326191026973	261
PESINI1W	9326191035104	172	PG3BARWH	9326191029684	259
PESINI2	9326191035173	55	PG4BARBL	9326191027017	257
PESINI2W	9326191035111	172	PG4BART	9326191026980	261
PESINI3	9326191035180	55	PG4BARWH	9326191029691	259
PESINI3W	9326191035128	172	PG4SQBL	9326191029707	257
PESINI4	9326191035197	55	PG4SQT	9326191029714	261
PESINI4W	9326191035135	172	PG4SQWH	9326191029660	259
PESINI5	9326191035203	55	PGUDBL	9326191026751	256

Index by Part Number

PART NO.	BARCODE	PAGE	PART NO.	BARCODE	PAGE
PGUDBR	9326191030185	255	PM1FBL	9326191022135	270
PGUDC	9326191026720	252	PM1FBR	9326191030239	268
PGUDCEC	9326191027123	253	PM1FC	9326191018206	265
PGUDCECA	9326191029875	254	PM1FCEC	9326191027093	266
PGUDSHSIL	9326191028137	264	PM1FCECA	9326191029868	267
PGUDSIL	9326191026775	263	PM1FSHSIL	9326191022104	273
PGUDSS	9326191026737	262	PM1FSIL	9326191022111	272
PGUDT	9326191026744	260	PM1FSS	9326191017247	269
PGUDWH	9326191026768	258	PM1FT	9326191022142	274
PHARE01G	9326191029721	278	PM1FWH	9326191022128	271
PHARE01M	9326191029981	279	PM2ABL	9326191019555	270
PHARE02G	9326191029738	278	PM2ABR	9326191030215	268
PHARE02M	9326191029998	279	PM2AC	9326191019586	265
PHARE03EXT	9326191032097	278	PM2ACEC	9326191027130	266
PHARE03G	9326191029752	278	PM2ACECA	9326191029905	267
PHARE03M	9326191029745	279	PM2ASHSIL	9326191019128	273
PHARE04EXT	9326191032103	278	PM2ASIL	9326191019135	272
PHARE04G	9326191029776	278	PM2ASS	9326191019579	269
PHARE04M	9326191029769	279	PM2AT	9326191019562	274
PHARE05G	9326191029790	278	PM2AWH	9326191019371	271
PHARE05M	9326191029783	279	PMUDBL	9326191021480	270
PHARE06M	9326191030260	293	PMUDBR	9326191030192	268
PHARE07M	9326191030277	293	PMUDC	9326191022098	265
PHOENIX	9326191015359	184	PMUDCEC	9326191027116	266
PIATTO1	9326191018831	155	PMUDCECA	9326191029882	267
PIATTO2	9326191018848	155	PMUDSHSIL	9326191018442	273
PILOT01	9326191034282	394	PMUDSIL	9326191018480	272
PLANA01	9326191032431	215	PMUDSS	9326191022081	269
PLANA02	9326191032615	215	PMUDT	9326191021725	274
PLC002	9326191031076	402	PMUDWH	9326191018497	271
PLIER1	9326191035913	47	PORTUS1FLC	9326191026416	280
PLIER2	9326191035937	47	PORTUS1FLSS	9326191026423	280
PLIER3	9326191035920	47	PORTUS1SPC	9326191026478	280
PLIER4	9326191035944	47	PORTUS1SPSS	9326191026485	280
PLUG001	9326191026263	442	PT818W5FT	9326191019548	404
PLUG002	9326191028373	442	PT827D5FT	9326191022708	404
PM1ABL	9326191020490	270	PT82FT4	9326191024351	404
PM1ABR	9326191030253	268	PT84FT4A	9326191033988	404
PM1AC	9326191021459	265	PUNK1	9326191020841	169
PM1ACEC	9326191027079	266	R		
PM1ACECA	9326191029844	267	R63L1B	9326191033377	394
PM1ASHSIL	9326191019906	273	R63L2B	9326191027611	394
PM1ASIL	9326191019913	272	R71A	9326191023828	395
PM1ASS	9326191021329	269	R72A	9326191023859	395
PM1AT	9326191021145	274	R73A	9326191023866	395
PM1AWH	9326191020261	271	R74A	9326191023873	395

Index by Part Number

PART NO.	BARCODE	PAGE	PART NO.	BARCODE	PAGE
R75	9326191037290	396	SEC02S	9326191029585	364
R76	9326191037306	396	SEC03S	9326191032158	365
R77	9326191037313	396	SEC04S	9326191032165	365
R78	9326191037320	396	SEKER1	9326191011559	287
R80L1B	9326191025792	394	SEKER2	9326191011542	287
R80L2B	9326191025808	394	SEKER3	9326191011535	287
RAZORDM001A	9326191032196	331	SENRITA1	9326191022227	101
RAZORDM002A	9326191032202	331	SENRITA2	9326191022234	101
RAZORDMW01	9326191032745	332	SENRITA3	9326191022241	101
RAZORDMW02	9326191032752	332	SENRITA4	9326191024368	101
REMO1	9326191028601	224	SENRITA5	9326191024375	101
REMO2	9326191028618	224	SENRITA6	9326191024382	101
REPISA01	9326191032424	214	SENS001	9326191025082	429
REPISA02	9326191032608	214	SENS002	9326191025099	429
RICTUS1	9326191027413	124	SENS003	9326191025105	430
RICTUS2	9326191027420	124	SENS004	9326191025112	431
RICTUS3	9326191027437	124	SENS005	9326191025129	432
RICTUS4	9326191027444	124	SENS007	9326191027710	433
RICTUS5	9326191027451	124	SENS008	9326191030673	433
RICTUS6	9326191027468	124	SENS009	9326191032134	434
RIOG2	9326191036613	184	SENS010	9326191032141	434
RIVERINA	9326191018886	129	SENS011	9326191034251	435
ROCHE1	9326191035258	57	SENSORHEADLIGHT	9323129088447	455
ROCHE2	9326191035265	57	SENTINEL1	9326191030031	140
ROCKY	9323129088461	458	SENTINEL2	9326191030048	140
ROMEG2	9326191025440	184	SETH1	9326191024825	285
ROTA1	9326191035968	43	SETH2	9326191024832	285
RUBIK1	9326191024863	201	SETH3	9326191024849	285
RUBIK2	9326191024870	201	SETH4	9326191024856	285
S			SG1ACEC	9326191027161	251
SADDLE001	9326191026188	438	SG1ACECA	9326191029813	251
SADDLE002	9326191026195	438	SHADE01	9326191031915	198
SADDLE003	9326191026201	438	SHADE02	9326191031922	198
SADDLE004	9326191026218	438	SHADE03	9326191031939	198
SADDLE005	9326191026225	438	SHADE04	9326191031946	198
SADDLE006	9326191026232	438	SHADE05	9326191031953	199
SADDLE007	9326191026249	438	SHADE06	9326191031960	199
SADDLE008	9326191026256	438	SHADE07	9326191031977	199
SARI1	9326191035951	40	SHADE08	9326191031984	199
SARI2	9326191036668	40	SHIELDTRI1	9326191034466	302
SEATTLE1	9326191013850	186	SHIELDTRI2	9326191034473	302
SEATTLE2	9326191013867	186	SHOPTRI	9326191031816	317
SEATTLE3	9326191013874	186	SHOPTRI01	9326191032738	316
SEC01	9326191029615	364	SHU1	9326191011597	281
SEC01S	9326191029592	364	SHU2	9326191011580	281
SEC02	9326191029608	364	SHU3	9326191011573	281

Index by Part Number

PART NO.	BARCODE	PAGE	PART NO.	BARCODE	PAGE
SHU4	9326191011566	281	SPMSSS86	9326191027178	290
SJS1200	9325574006298	445	SPMST	9326191027222	290
SJS1500	9325574006304	446	SPOT-BAR2B	9326191032813	321
SJS1500TP	9325574006304	446	SPOT-BAR2W	9326191032806	322
SJS3000	9326191029486	447	SPOT-BAR3B	9326191032837	321
SKOPA1	9326191024900	205	SPOT-BAR3W	9326191032820	322
SKOPA2	9326191024917	205	SPOT-BAR4B	9326191032851	321
SLICKTRI1R	9326191032486	315	SPOT-BAR4W	9326191032844	322
SLICKTRI1S	9326191032516	315	SPOT-R1B	9326191032776	321
SLICKTRI2R	9326191032493	315	SPOT-R1W	9326191032769	322
SLICKTRI2S	9326191032523	315	SPOT-R3B	9326191032875	321
SLICKTRI3R	9326191032509	315	SPOT-R3W	9326191032868	322
SLICKTRI3S	9326191032530	315	SPOT-S1B	9326191032790	321
SLIM BENDY	9323129088454	458	SPOT-S1W	9326191032783	322
SM1ACEC	9326191027154	251	SPUTNIK1	9326191023330	94
SM1ACECA	9326191029820	251	SPUTNIK2	9326191023347	179
SMIP68ASS	9326191029264	293	SPY-C1	9326191019760	202
SMTFLOOD1	9326191036866	19	SPY-C2	9326191019753	202
SMTFLOOD2	9326191036873	19	SPY-W1	9326191019746	202
SMTGLS1	9326191032219	21	SPY-W2	9326191019739	202
SMTGLS2	9326191032226	21	STE1	9326191015021	243
SMTGU101	9326191034381	20	STE10	9326191026652	245
SMTNOVA1	9326191032233	17	STE12	9326191026676	246
SMTOYS1	9326191032240	18	STE13	9326191029233	247
SOCK2	9326191025136	439	STE14	9326191029240	247
SOCK3	9326191029417	439	STE15	9326191030284	247
SOMBRA01	9326191032462	211	STE16	9326191030291	247
SOMBRA02	9326191032646	211	STE17	9326191030307	247
SPECTRA01	9326191028762	397	STE18	9326191030314	247
SPECTRA02	9326191028779	397	STE19	9326191030796	248
SPECTRA03	9326191028786	397	STE2	9326191015038	243
SPECTRA04	9326191028793	397	STE20	9326191030802	248
SPIAGGIA1	9326191023255	136	STE21	9326191030819	248
SPIAGGIA2	9326191023262	136	STE22	9326191030826	248
SPIAGGIA3	9326191023279	136	STE23	9326191036507	246
SPIAGGIA4	9326191023286	136	STE3	9326191015045	243
SPM1ALBL	9326191030680	289	STE4	9326191015052	243
SPM1ALC	9326191026430	289	STE5	9326191025259	244
SPM1ALSS	9326191026447	289	STE6	9326191025266	244
SPM2ALBL	9326191029806	289	STE7	9326191025587	244
SPM2ALC	9326191026454	289	STE8	9326191025594	244
SPM2ALSS	9326191026461	289	STE9	9326191026645	245
SPMSBL	9326191027215	290	STEAM1	9326191020810	176
SPMSBL86	9326191027185	290	STEAM2	9326191020827	176
SPMSC	9326191027208	290	STEAM3	9326191020834	176
SPMSSS	9326191027192	290	STRAND1	9326191023231	137

Index by Part Number

PART NO.	BARCODE	PAGE	PART NO.	BARCODE	PAGE
STRAND2	9326191023248	137	TAMBURA12FL	9326191028755	163
STRATO1	9326191029370	91	TOCA1	9326191028625	228
STRUNG1	9326191026102	174	TOCA2	9326191028632	228
SUB3	9326191027390	393	TOCA3	9326191033254	229
SUB4	9326191027406	393	TOCA4	9326191033261	229
SURFACE13	9326191025273	319	TOE2530PRO	9325574003419	461
SURFACE14	9326191025280	319	TONO1	9326191024115	133
SURFACE17A	9326191032882	318	TONO2	9326191024122	133
SURFACE18A	9326191032899	318	TONO3	9326191024139	133
SURFACE22	9326191032905	318	TOPA0001	9326191025600	223
SURFACE23	9326191032912	318	TOPA0002	9326191025617	223
SURFACE24	9326191032929	318	TORQUE1	9326191019708	208
SURFACE25	9326191032936	318	TORQUE2	9326191019685	208
SURFACETRI1R	9326191032547	329	TORQUE3	9326191029943	209
SURFACETRI1S	9326191032578	329	TORQUE4	9326191029950	209
SURFACETRI2R	9326191032554	329	TORRE1	9326191036033	277
SURFACETRI3R	9326191032561	329	TORRE2	9326191036040	277
SURFACETRI3S	9326191032592	329	TORRE3	9326191036057	277
SWING1	9326191021916	107	TORRE4	9326191036064	277
SWING2	9326191021923	107	TORRE5	9326191036071	277
SWING3	9326191021930	107	TORRE6	9326191036088	277
SWING4	9326191021947	107	TP001	9325574006076	445
SWING5	9326191021954	107	TRATTINO1	9326191034879	63
SWING6	9326191021961	107	TRATTINO1X3R	9326191034893	63
SYDNEYG2	9326191029516	185	TRATTINO1X3S	9326191034886	63
T			TRATTINO2	9326191034909	63
TABLET2B	9326191014543	300	TRATTINO2X3R	9326191034923	63
TACHE1	9326191037085	159	TRATTINO2X3S	9326191034916	63
TACHE2	9326191037092	159	TREEC	9326191027062	203
TACHE3	9326191037108	159	TRK1BL1M	9326191033384	351
TACHE4	9326191037115	160	TRK1BL2M	9326191033391	351
TACHE5	9326191037122	160	TRK1BLADAP1	9326191035692	355
TACHE6	9326191037139	160	TRK1BLADAP2	9326191035715	355
TAMA1	9326191028588	224	TRK1BLCON1	9326191033421	351
TAMA2	9326191028595	224	TRK1BLCON2	9326191033438	351
TAMBURA01	9326191028656	106	TRK1BLCON3L	9326191033445	352
TAMBURA02	9326191028649	106	TRK1BLCON3R	9326191033452	352
TAMBURA03	9326191028670	106	TRK1BLCON4L1	9326191033469	352
TAMBURA04	9326191028663	106	TRK1BLCON4L2	9326191033476	352
TAMBURA05	9326191028694	106	TRK1BLCON4R1	9326191033483	352
TAMBURA06	9326191028687	106	TRK1BLCON4R2	9326191033490	352
TAMBURA07TL	9326191028717	162	TRK1BLCON5	9326191033506	353
TAMBURA08TL	9326191028700	162	TRK1BLCON6L	9326191033513	353
TAMBURA09TL	9326191028724	162	TRK1BLCON6R	9326191033995	353
TAMBURA10TL	9326191028731	162	TRK1BLEND	9326191033520	353
TAMBURA11FL	9326191028748	163	TRK1BLLIVEL	9326191033407	353

Index by Part Number

PART NO.	BARCODE	PAGE	PART NO.	BARCODE	PAGE
TRK1BLLIVER	9326191033414	353	TRK3WH1M	9326191033834	343
TRK1WH1M	9326191033537	351	TRK3WH2M	9326191033841	343
TRK1WH2M	9326191033544	351	TRK3WHADAP3	9326191035722	348
TRK1WHADAP1	9326191035685	355	TRK3WHADAP4	9326191035746	348
TRK1WHADAP2	9326191035708	355	TRK3WHCEILKIT1	9326191035609	346
TRK1WHCON1	9326191033575	351	TRK3WHCEILKIT2	9326191035623	346
TRK1WHCON2	9326191033582	351	TRK3WHCON1	9326191033872	343
TRK1WHCON3L	9326191033599	352	TRK3WHCON2	9326191033889	343
TRK1WHCON3R	9326191033605	352	TRK3WHCON3L	9326191033896	344
TRK1WHCON4L1	9326191033612	352	TRK3WHCON3R	9326191033902	344
TRK1WHCON4L2	9326191033629	352	TRK3WHCON4L1	9326191033919	344
TRK1WHCON4R1	9326191033636	352	TRK3WHCON4L2	9326191033926	344
TRK1WHCON4R2	9326191033643	352	TRK3WHCON4R1	9326191033933	344
TRK1WHCON5	9326191033650	353	TRK3WHCON4R2	9326191033940	344
TRK1WHCON6L	9326191033667	353	TRK3WHCON5	9326191033957	345
TRK1WHCON6R	9326191034008	353	TRK3WHCON6	9326191033964	345
TRK1WHEND	9326191033674	353	TRK3WHEND	9326191033971	346
TRK1WHLIVEL	9326191033551	353	TRK3WHFLEXCON	9326191035678	345
TRK1WHLIVER	9326191033568	353	TRK3WHLIVEL	9326191033858	346
TRK3BL1M	9326191033384	343	TRK3WHLIVER	9326191033865	346
TRK3BL2M	9326191033698	343	TRK3WHNIPCON	9326191035760	348
TRK3BLADAP3	9326191035739	348	TRK3WHSUSCLAMP	9326191035616	350
TRK3BLADAP4	9326191035753	348	TRK3WHSUSKIT1	9326191035586	349
TRK3BLCEILKIT1	9326191035524	346	TRK3WHSUSKIT2	9326191035593	349
TRK3BLCEILKIT2	9326191035548	346	TRK3WHSUSKIT3	9326191035630	349
TRK3BLCON1	9326191033728	343	TRK3WHSUSKIT4	9326191035647	349
TRK3BLCON2	9326191033735	343	TRK3WHSUSKIT5	9326191035654	350
TRK3BLCON3L	9326191033742	344	TRKB1G002	9326191034510	335
TRK3BLCON3R	9326191033759	344	TRKB3G002	9326191034534	335
TRK3BLCON4L1	9326191033766	344	TRKTRI01	9326191036965	336
TRK3BLCON4L2	9326191033773	344	TRKTRI02	9326191036972	336
TRK3BLCON4R1	9326191033780	344	TRKW1G002	9326191034527	335
TRK3BLCON4R2	9326191033797	344	TRKW3G002	9326191034541	335
TRK3BLCON5	9326191033803	345	TUILE1	9326191033094	51
TRK3BLCON6	9326191033810	345	TUILE2	9326191033100	51
TRK3BLEND	9326191033827	346	TUILE3	9326191033117	51
TRK3BLFLEXCON	9326191035661	345	TUILE4	9326191033124	51
TRK3BLLIVEL	9326191033704	346	TUILE5	9326191033131	51
TRK3BLLIVER	9326191033711	346	TUILE6	9326191033148	51
TRK3BLNIPCON	9326191035777	348	TULIP1	9326191034817	65
TRK3BLSUSCLAMP	9326191035531	350	TULIP1X3R	9326191034831	65
TRK3BLSUSKIT1	9326191035500	349	TULIP1X3S	9326191034824	65
TRK3BLSUSKIT2	9326191035517	349	TULIP2	9326191034848	65
TRK3BLSUSKIT3	9326191035555	349	TULIP2X3R	9326191034862	65
TRK3BLSUSKIT4	9326191035562	349	TULIP2X3S	9326191034855	65
TRK3BLSUSKIT5	9326191035579	350			

U

Index by Part Number

PART NO.	BARCODE	PAGE
ULAN1	9326191011528	240
ULAN2	9326191011511	240
V		
VAINA1	9326191035005	74
VAINA2	9326191035012	74
VAINA3	9326191035029	74
VAINA4	9326191035036	74
VANITY-1	9326191025013	190
VANITY-2	9326191025051	190
VELA	9326191025532	427
VENETO1BK	9326191021879	138
VENETO1X3BK	9326191021886	138
VENETO-T1	9326191021978	168
VENETO-T2	9326191021985	168
VENETO-W1	9326191022005	177
VENETO-W2	9326191021992	177
VENICEG2	9326191027369	185
VIENNA	9326191014468	185
VIGOL	9326191026119	187
VIGOR	9326191026003	187
VINTAJ1	9326191036675	23
VINTAJ10	9326191036767	24
VINTAJ11	9326191036774	24
VINTAJ12	9326191036781	24
VINTAJ13	9326191036798	25
VINTAJ14	9326191036804	25
VINTAJ15	9326191036811	25
VINTAJ16	9326191036828	25
VINTAJ17	9326191036835	25
VINTAJ18	9326191036842	25
VINTAJ2	9326191036682	23
VINTAJ3	9326191036699	23
VINTAJ4	9326191036705	23
VINTAJ5	9326191036712	23
VINTAJ6	9326191036729	23
VINTAJ7	9326191036736	24
VINTAJ8	9326191036743	24
VINTAJ9	9326191036750	24
VINUM1	9326191035081	56
VINUM1W	9326191035067	173
VINUM2	9326191035098	56
VINUM2W	9326191035074	173
VOTIF1	9326191036934	28
VOX1	9326191028564	227
VOX2	9326191028571	227
VOX3	9326191010897	227

PART NO.	BARCODE	PAGE
W		
WEDGEGBL	9326191027048	230
WEDGEGC	9326191027024	230
WEDGEGSS	9326191027031	230
WEDGEGWH	9326191027055	230
WHITEBAND1X3	9326191020001	144
WHITEBAND2X3	9326191020018	144
WHITEBAND5	9326191020025	143
WHITEBAND6	9326191020032	143
WIG1	9326191010972	226
WIG2	9326191010965	226
WINDSCREENREPKIT	9323129058037	454
Y		
YARRA	9326191018862	129
Z		
ZARA10A	9326191031458	115
ZARA1A	9326191031038	114
ZARA2A	9326191031465	114
ZARA3A	9326191031045	114
ZARA4A	9326191031052	114
ZARA5A	9326191031069	114
ZARA6A	9326191031830	115
ZARA7A	9326191031847	115
ZARA8A	9326191033360	115
ZARA9A	9326191033346	115
ZONE15FILTER1	9326191034213	340
ZONE15FILTER2	9326191034220	340
ZONE15FILTER3	9326191034237	340
ZONE15FILTER4	9326191034244	340
ZONE15LENS1	9326191034152	339
ZONE1BK	9326191034022	337
ZONE1WH	9326191034039	337
ZONE36LENS1	9326191034169	339
ZONE36LENS2	9326191034176	339
ZONE36LENS3	9326191034183	339
ZONEBARNBK	9326191034084	341
ZONEBARNWH	9326191034091	341
ZONECOLOUR	9326191034206	340
ZONEHONEY	9326191034190	340
ZONEREF1	9326191034145	339
ZONERING1BK	9326191034046	339
ZONERING1WH	9326191034060	339
ZONERING2BK	9326191034053	339
ZONERING2WH	9326191034077	339
ZONESHADE1BK	9326191034107	341
ZONESHADE1WH	9326191034121	341

Index by Part Number

PART NO.	BARCODE	PAGE
ZONESHADE2BK	9326191034114	341
ZONESHADE2WH	9326191034138	341

PART NO.	BARCODE	PAGE
----------	---------	------

General Contact & Accounts Enquiries

Sydney Head Office

Unit 2 16 Ada Brookvale NSW 2100

T: 02 9938 7100

F: 02 9938 7115

E: sales@clalighting.com.au

P.O. Box 7245 Warringah Mall

NSW 2100

National Sales Manager

Annie Davis

E: annie@clalighting.com.au

Northern NSW

T: 02 9938 7100 (EST 8:00AM - 5:00PM)

E: sales@clalighting.com.au

Sydney / Southern NSW

Kathryn Rowan

M: 0403 098 651

E: nsw2@clalighting.com.au

QLD

Mary-Lou Morris

M: 0418 113 180

E: qld1@clalighting.com.au

VIC / TAS

Glen Symss

M: 0421 826 859

E: vic2@clalighting.com.au

WA

Chandraj Sinha

M: 0413 586 447

E: wa1@clalighting.com.au

SA/ NT

T: 02 9938 7100 (EST 8:00AM - 5:00PM)

E: sales@clalighting.com.au

New Zealand Head Office

20C Manga Road Silverdale Auckland 0932

T: 09 427 6133

E: sales@clalighting.co.nz

North Island

Churchill Velpula

M: 021 702 031

E: northisland@clalighting.co.nz

South Island

T: 09 427 6133

E: sales@clalighting.co.nz

**100% Australian
Owned Company
EST.1999**

Check CLA website to view our latest products

Australia: www.clalighting.com.au

New Zealand: www.clalighting.co.nz

Facebook: www.facebook.com/clalighting

Instagram: www.instagram.com/cla.lighting