

fienza[®]

Australian Made Vanities



VANITIES • MIRRORS • MIRROR CABINETS • TALLBOYS

DESIGNED & MADE IN *Australia*

Fienza has been an industry leader in manufacturing and supplying bathroom vanities throughout Australia for over 14 years. As an Australian owned company, we pride ourselves on product innovation and exceptional customer service.

Expanding our commitment to Australian made products, Fienza is proud to launch our Australian Made Vanity range. Our local manufacturing facility in Brisbane has been crafting quality cabinetry since 1968. Our wealth of manufacturing and design expertise will bring you a vanity that is beautiful, functional and built to last.

WHAT MAKES OUR PRODUCTS UNIQUE?

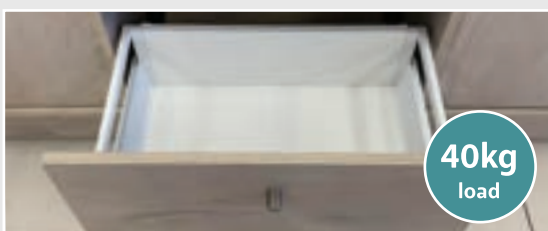

Full Extension, *Confident Close* Damping System

The easy-pull drawers on our Fienza Australian Made cabinets now come with a 'confident close' damping system. This feature combines smooth, fast closing with late deceleration to provide a quiet landing on close. Full extension runners, load rated at 40 kg, allow easy access to the full depth of the drawer.

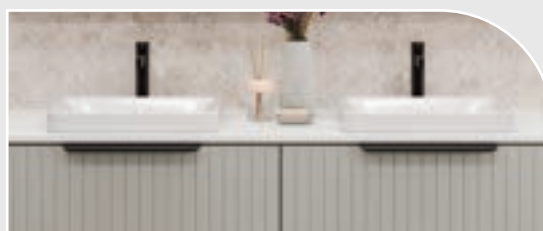

Eco-Friendly, Moisture Resistant Board

All of our cabinetry is made with moisture resistant board to protect against swelling and moisture damage. Our raw materials are FSC certified and made from eco-friendly, low formaldehyde E0 board.

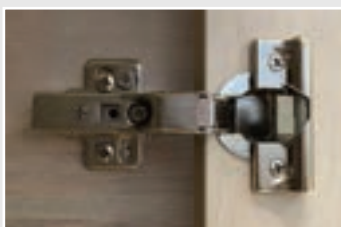

Soft Close Doors

All door hinges include a soft close mechanism that ensures smooth and silent operation and long term durability for your vanity.



Durable Edging

We only use strong ABS edging on our woodgrain finish cabinets that will ensure maximum durability where you need it most.



Endless Customisation Options

Personalise your vanity by choosing from an extensive range of cabinet finishes, handles, benchtops, and basins. With endless combinations available, you can create a style unique to you.



LIFETIME WARRANTY ON DRAWER RUNNERS

We offer a lifetime warranty on the quality of material, composition and function of the drawer runners on our Australian made cabinetry.



10 YEAR WARRANTY ON CABINETRY BOARD

We offer a 10-year warranty on our Australian made MDF cabinetry materials and a 5-year warranty on all handles and hinges; and, a 1-year warranty on mirrors and mirror doors.

Contents

Kassi Vanities	4-9
Full Depth Vanities	6-8
Ensuite Vanities	9
Cierra Vanities	10-13
Bayview Vanities	14-17
Carmen Vanities	18-29
Door & Drawer Full Depth Vanities	18-22
Door & Drawer Ensuite Vanities	23
All Drawer Full Depth Vanities	24-28
All Drawer Ensuite Vanities	29
Newport Vanities	30-41
Door & Drawer Full Depth Vanities	30-34
Door & Drawer Ensuite Vanities	35
All Drawer Full Depth Vanities	36-40
All Drawer Ensuite Vanities	41
Riley Slim Ensuite Vanities	42-43
Aluca Mirrors	44-45
Mirrors	44
Framed Mirrors	45
Mirror Cabinets & Storage	46-51
Mirror Cabinets	46
Display Shelf Mirror Cabinets	47
Wall Cabinets	48
Combination Cabinets	49
Tallboys	50
Customise Your Vanity	52-69
Cabinet Finishes	52-56
Cabinet Handles	57-59
Vanity Top & Basin Materials Guide	60
Moulded Basin-Tops	61
Stone & Timber Top Finishes	62-63
Basins	64-68
Basin Wastes & Overflow Rings	69
Order Forms	70-72



Kassi 1200 mm Wall-Hung Full Depth Vanity Cabinet, White Painted Wood;
 Edge 200 mm Handles, Matte Black; Terrazzo Nougat 1200 mm Stone Top • \$2320
 Sarah Semi-Inset Ceramic Basin, Gloss White (including basin hole cut) • \$199



Kassi 750 mm Floor Standing Ensuite Depth Vanity Cabinet, Notaio Walnut;
 Kaya Point Knobs, Gun Metal; Roman Sand 750 mm Stone Top • \$1955
 Bahama Above Counter Cast Stone Basin, Matte White • \$399



Kassi 1200 mm Wall-Hung Vanity Cabinet, Elegant Oak;
 Urbane 192 mm Handles, Matte Black; Crystal Pure 1200 mm Stone Top • \$2060
 Koko 465 Above Counter Ceramic Basin, Gloss White • \$199

Kassi

VANITIES

The Kassi vanity blends the perfect combination of design and function with large drawers and an open bottom shelf for convenient storage. The open design captures an airy feel that is ideal for bathrooms or ensuites to amplify the space.

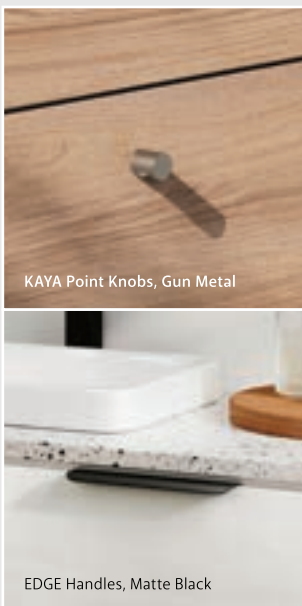

KAYA Point Knobs, Gun Metal

EDGE Handles, Matte Black

- Select from over 20 woodgrain cabinet finishes (see pages 52-55)
- Horizontal woodgrain direction
- ‘Confident close’ drawer damping system combines smooth, fast closing with late deceleration to provide a quiet landing on close
- Full extension runners allow easy access to the full depth of the drawer
- Wall-hung or floor standing
- Full depth (suits 465 mm tops) or ensuite depth (suits 365 mm tops)
- Your choice of bevelled finger-pull or handles (included in price; see pages 57-59)
- Made in Australia with FSC certified, E0 board

AVAILABLE WIDTHS

				
600	750	900	1200 Single Bowl	1200 Double Bowl
				
1500 Single Bowl (Full depth only)	1500 Double Bowl (Full depth only)	1800 Single Bowl (Full depth only)	1800 Double Bowl (Full depth only)	



Bring out your creative side with over 20 cabinet finishes to choose from on pages 52-55.



Choose a slimline finger-pull design, or accent your cabinetry with handles on pages 57-59.



Select from our extensive range of benchtops and basins on pages 60-69.



Order your dream vanity with our easy-to-use order forms on pages 70-72.

KASSI, FULL DEPTH VANITIES

FULL DEPTH	Wall-Hung		Floor Standing	
600 mm One Drawer (Wall-Hung) Two Drawers (Floor Standing)				
VANITY INCLUDES	CODE	RRP	CODE	RRP
Ceramic Basin-Top - Dolce	K60W-D	\$1320	K60F-D	\$1669
Poly-Marble Basin-Top - Vanessa	K60W-V	\$1320	K60F-V	\$1669
Ceramic Basin-Top - Joli	K60W-J	\$1341	K60F-J	\$1690
Ceramic Basin-Top - Rotondo	K60W-R	\$1205	K60F-R	\$1798
Standard Stone Top*	K60W-S	\$1569	K60F-S	\$1897
Premium Stone Top*	K60W-P	\$1770	K60F-P	\$2135
Australian Hardwood Top*	K60W-T	\$2030	K60F-T	\$2095

*Basin at additional cost.

FULL DEPTH	Wall-Hung		Floor Standing	
750 mm One Drawer (Wall-Hung) Two Drawers (Floor Standing)				
VANITY INCLUDES	CODE	RRP	CODE	RRP
Ceramic Basin-Top - Dolce	K75W-D	\$1450	K75F-D	\$1805
Poly-Marble Basin-Top - Vanessa	K75W-V	\$1450	K75F-V	\$1805
Ceramic Basin-Top - Joli	K75W-J	\$1476	K75F-J	\$1835
Ceramic Basin-Top - Rotondo	K75W-R	\$1600	K75F-R	\$1955
Ceramic Basin-Top - Dolce Matte Black	K75W-DB	\$1730	K75F-DB	\$2035
Concrete Basin-Top - Satori	K75W-SC	\$2240	K75F-SC	\$2620
Standard Stone Top*	K75W-S	\$1730	K75F-S	\$2059
Premium Stone Top*	K75W-P	\$1950	K75F-P	\$2320
Australian Hardwood Top*	K75W-T	\$2250	K75F-T	\$2620

*Basin at additional cost.

FULL DEPTH	Wall-Hung		Floor Standing	
900 mm One Drawer (Wall-Hung) Two Drawers (Floor Standing)				
VANITY INCLUDES	CODE	RRP	CODE	RRP
Ceramic Basin-Top - Dolce	K90W-D	\$1535	K90F-D	\$1925
Poly-Marble Basin-Top - Vanessa	K90W-V	\$1535	K90F-V	\$1925
Ceramic Basin-Top - Joli	K90W-J	\$1561	K90F-J	\$1965
Ceramic Basin-Top - Rotondo	K90W-R	\$1665	K90F-R	\$2055
Ceramic Basin-Top - Dolce Matte Black	K90W-DB	\$1875	K90F-DB	\$2265
Concrete Basin-Top - Satori	K90W-SC	\$2550	K90F-SC	\$2925
Standard Stone Top*	K90W-S	\$1960	K90F-S	\$2335
Premium Stone Top*	K90W-P	\$2240	K90F-P	\$2670
Australian Hardwood Top*	K90W-T	\$2550	K90F-T	\$2980

*Basin at additional cost.

KASSI, FULL DEPTH VANITIES

FULL DEPTH	Wall-Hung		Floor Standing	
1200 mm Single Bowl Two Drawers (Wall-Hung) Four Drawers (Floor Standing)				
VANITY INCLUDES	CODE	RRP	CODE	RRP
Ceramic Basin-Top - Dolce	K120W-D	\$1899	K120F-D	\$2500
Poly-Marble Basin-Top - Vanessa	K120W-V	\$1899	K120F-V	\$2500
Ceramic Basin-Top - Joli	K120W-J	\$2000	K120F-J	\$2550
Ceramic Basin-Top - Rotondo	K120W-R	\$2050	K120F-R	\$2550
Ceramic Basin-Top - Dolce Matte Black	K120W-DB	\$1950	K120F-DB	\$3200
Concrete Basin-Top - Satori	K120W-SC	\$3130	K120F-SC	\$3685
Standard Stone Top*	K120W-S	\$2320	K120F-S	\$2845
Premium Stone Top*	K120W-P	\$2720	K120F-P	\$3275
Australian Hardwood Top*	K120W-T	\$3130	K120F-T	\$3685

*Basin at additional cost.

FULL DEPTH	Wall-Hung		Floor Standing	
1200 mm Double Bowl Two Drawers (Wall-Hung) Four Drawers (Floor Standing)				
VANITY INCLUDES	CODE	RRP	CODE	RRP
Ceramic Basin-Top - Dolce	K120WD-D	\$3350	K120FD-D	\$2945
Standard Stone Top*	K120WD-S	\$2060	K120FD-S	\$2369
Premium Stone Top*	K120WD-P	\$2575	K120FD-P	\$2960
Australian Hardwood Top*	K120W-T	\$2975	K120F-T	\$3360

*Basin at additional cost.

FULL DEPTH	Wall-Hung		Floor Standing	
1500 mm Single Bowl Two Drawers (Wall-Hung) Four Drawers (Floor Standing)				
VANITY INCLUDES	CODE	RRP	CODE	RRP
Ceramic Basin-Top - Dolce	K150WS-D	\$2834	K150FS-D	\$3629
Poly-Marble Basin-Top - Vanessa	K150WS-V	\$2634	K150FS-V	\$3429
Standard Stone Top*	K150WS-S	\$3170	K150FS-S	\$3735
Premium Stone Top*	K150WS-P	\$3595	K150FS-P	\$4190
Australian Hardwood Top*	K150WS-T	\$3995	K150FS-T	\$4590

*Basin at additional cost.

Continued on next page



Bring out your creative side with over 20 cabinet finishes to choose from on pages 52-55.



Choose a slimline finger-pull design, or accent your cabinetry with handles on pages 57-59.



Select from our extensive range of benchtops and basins on pages 60-69.



Order your dream vanity with our easy-to-use order forms on pages 70-72.

KASSI, FULL DEPTH VANITIES

FULL DEPTH	Wall-Hung		Floor Standing	
1500 mm Double Bowl Two Drawers (Wall-Hung) Four Drawers (Floor Standing)				
VANITY INCLUDES	CODE	RRP	CODE	RRP
Ceramic Basin-Top - Dolce	K150WD-D	\$3040	K150FD-D	\$3835
Poly-Marble Basin-Top - Vanessa	K150WD-V	\$2840	K150FD-V	\$3635
Standard Stone Top*	K150WD-S	\$3379	K150FD-S	\$4475
Premium Stone Top*	K150WD-P	\$3830	K150FD-P	\$4737
Australian Hardwood Top*	K150WD-T	\$4230	K150FD-T	\$5137

*Basin at additional cost.

FULL DEPTH	Wall-Hung		Floor Standing	
1800 mm Single Bowl Two Drawers (Wall-Hung) Four Drawers (Floor Standing)				
VANITY INCLUDES	CODE	RRP	CODE	RRP
Poly-Marble Basin-Top - Vanessa	K180WS-V	\$3020	K180FS-V	\$3745
Standard Stone Top*	K180WS-S	\$3640	K180FS-S	\$4150
Premium Stone Top*	K180WS-P	\$4325	K180FS-P	\$4850
Australian Hardwood Top*	K180WS-T	\$4825	K180FS-T	\$5350

*Basin at additional cost.

FULL DEPTH	Wall-Hung		Floor Standing	
1800 mm Double Bowl Two Drawers (Wall-Hung) Four Drawers (Floor Standing)				
VANITY INCLUDES	CODE	RRP	CODE	RRP
Poly-Marble Basin-Top - Vanessa	K180WD-V	\$3165	K180FD-V	\$4000
Standard Stone Top*	K180WD-S	\$3800	K180FD-S	\$4255
Premium Stone Top*	K180WD-P	\$4510	K180FD-P	\$4975
Australian Hardwood Top*	K180WD-T	\$5010	K180FD-T	\$5475

*Basin at additional cost.

KASSI, ENSUITE DEPTH VANITIES

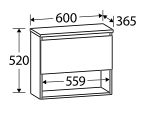
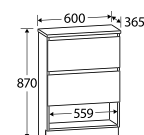
ENSUITE DEPTH	Wall-Hung		Floor Standing	
600 mm One Drawer (Wall-Hung) Two Drawers (Floor Standing)				
VANITY INCLUDES	CODE	RRP	CODE	RRP
Ceramic Basin-Top - Delgado	KE60W-DT	\$1265	KE60F-DT	\$1589
Standard Stone Top*	KE60W-S	\$1489	KE60F-S	\$1798
Premium Stone Top*	KE60W-P	\$1670	KE60F-P	\$2014

*Basin at additional cost.

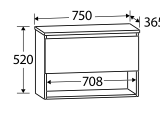
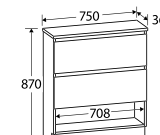
ENSUITE DEPTH	Wall-Hung		Floor Standing	
750 mm One Drawer (Wall-Hung) Two Drawers (Floor Standing)				
VANITY INCLUDES	CODE	RRP	CODE	RRP
Ceramic Basin-Top - Delgado	KE75W-DT	\$1119	KE75F-DT	\$1439
Standard Stone Top*	KE75W-S	\$1637	KE75F-S	\$1955
Premium Stone Top*	KE75W-P	\$1895	KE75F-P	\$2246

*Basin at additional cost.

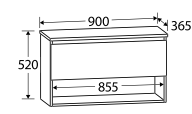
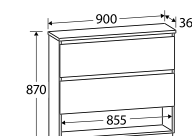
ENSUITE DEPTH	Wall-Hung		Floor Standing	
900 mm One Drawer (Wall-Hung) Two Drawers (Floor Standing)				
VANITY INCLUDES	CODE	RRP	CODE	RRP
Ceramic Basin-Top - Delgado	KE90W-DT	\$1129	KE90F-DT	\$1509
Standard Stone Top*	KE90W-S	\$1865	KE90F-S	\$2222
Premium Stone Top*	KE90W-P	\$2135	KE90F-P	\$2532

*Basin at additional cost.

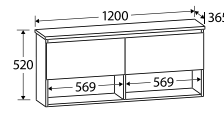
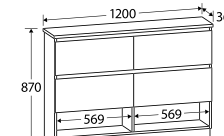
ENSUITE DEPTH	Wall-Hung		Floor Standing	
1200 mm Two Drawers (Wall-Hung) Four Drawers (Floor Standing)				
VANITY INCLUDES	CODE	RRP	CODE	RRP
Ceramic Basin-Top - Delgado	KE120W-DT	\$1409	KE120F-DT	\$1699
Standard Stone Top*	KE120W-S	\$2220	KE120F-S	\$2729
Premium Stone Top*	KE120W-P	\$2590	KE120F-P	\$3134

*Basin at additional cost.



Cierra 1800 mm Wall-Hung Vanity Cabinet, Angora Oak;
Kaya Point Knobs, Brushed Nickel; Polar Sacco 1800 mm Stone Top • \$4199
RAK Cloud Above Counter Ceramic Basins, Matte White • \$516 each



Cierra 900 mm Wall-Hung Vanity Cabinet Left Drawers, Black Nuance;
Kaya Point Knobs, Matte White; Crystal Pure 900 mm Stone Top • \$2099
Reba Mini Above Counter Ceramic Basin, Gloss White • \$199



Cierra 1200 mm Wall-Hung Vanity Cabinet, Tasmanian Oak; Mila Shaker Knobs, Urban Brass; Roman Sand 1200 mm Stone Top • \$2499
Forma Above Counter Ceramic Basin, Gloss White • \$249

Cierra VANITIES

The architectural style of Cierra's inset doors and drawers takes a modern approach to the traditional shaker style cabinetry. The compact design is enhanced with clean lines and rectangular shapes to create a focal point in your bathroom space.

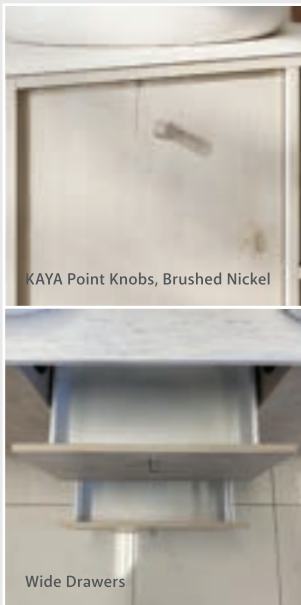

- Select from over 20 woodgrain cabinet finishes (see pages 52-55)
- Vertical woodgrain direction for 750 and 900 mm; mix of horizontal and vertical direction for 1200, 1500 and 1800 mm as standard
- 'Confident close' drawer damping system combines smooth, fast closing with late deceleration to provide a quiet landing on close
- Full extension runners allow easy access to the full depth of the drawer
- Wall-hung or floor standing
- Full depth (suits 465 mm tops)
- Left and right-hand drawers available (dependent on size)
- Your choice of handles (required; included in price; see pages 57-59)
- Made in Australia with FSC certified, E0 board

AVAILABLE WIDTHS

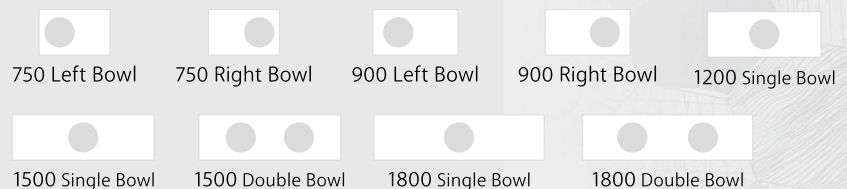

Please note: Undermount basins are not compatible with Cierra cabinets.

CIERRA, FULL DEPTH VANITIES

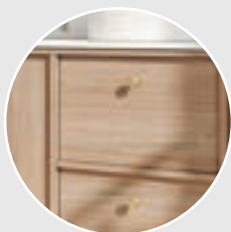

Bring out your creative side with over 20 cabinet finishes to choose from on pages 52-55.

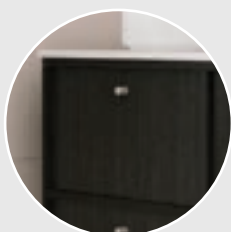

Customise by selecting from our extensive range of handles (required) on pages 57-59.



Select from our extensive range of benchtops and basins on pages 60-69.



Order your dream vanity with our easy-to-use order forms on pages 70-72.

FULL DEPTH	Wall-Hung		
750 mm One Door, Two Drawers (Left or Right Drawers)	<p>Left drawer, left bowl model shown</p>		
VANITY INCLUDES	LEFT DRAWER	RIGHT DRAWER	RRP
Concrete Basin-Top - Satori	CR75WL-SC	CR75WR-SC	\$2419
Standard Stone Top*	CR75WL-S	CR75WR-S	\$1899
Premium Stone Top*	CR75WL-P	CR75WR-P	\$2099
Australian Hardwood Top*	CR75WL-T	CR75WR-T	\$2429

*Basin at additional cost.

FULL DEPTH	Floor Standing		
750 mm One Door, Two Drawers (Left or Right Drawers)	<p>Left drawer, left bowl model shown</p>		
VANITY INCLUDES	LEFT DRAWER	RIGHT DRAWER	RRP
Concrete Basin-Top - Satori	CR75FL-SC	CR75FR-SC	\$2669
Standard Stone Top*	CR75FL-S	CR75FR-S	\$2089
Premium Stone Top*	CR75FL-P	CR75FR-P	\$2319
Australian Hardwood Top*	CR75FL-T	CR75FR-T	\$2649

*Basin at additional cost.

FULL DEPTH	Wall-Hung		
900 mm One Door, Two Drawers (Left or Right Drawers)	<p>Left drawer, left bowl model shown</p>		
VANITY INCLUDES	LEFT DRAWER	RIGHT DRAWER	RRP
Ceramic Basin-Top - Dolce	CR90WL-D	CR90WR-D	\$1649
Concrete Basin-Top - Satori	CR90WL-SC	CR90WR-SC	\$2749
Standard Stone Top*	CR90WL-S	CR90WR-S	\$2099
Premium Stone Top*	CR90WL-P	CR90WR-P	\$2429
Australian Hardwood Top*	CR90WL-T	CR90WR-T	\$2755

*Basin at additional cost.

FULL DEPTH	Floor Standing		
900 mm One Door, Two Drawers (Left or Right Drawers)	<p>Left drawer, left bowl model shown</p>		
VANITY INCLUDES	LEFT DRAWER	RIGHT DRAWER	RRP
Ceramic Basin-Top - Dolce	CR90FL-D	CR90FR-D	\$1949
Concrete Basin-Top - Satori	CR90FL-SC	CR90FR-SC	\$3049
Standard Stone Top*	CR90FL-S	CR90FR-S	\$2399
Premium Stone Top*	CR90FL-P	CR90FR-P	\$2729
Australian Hardwood Top*	CR90FL-T	CR90FR-T	\$3049

*Basin at additional cost.

CIERRA, FULL DEPTH VANITIES

FULL DEPTH	Wall-Hung		Floor Standing	
1200 mm Single Bowl Two Doors, Two Drawers				
VANITY INCLUDES	CODE	RRP	CODE	RRP
Ceramic Basin-Top - Dolce	CR120WS-D	\$2099	CR120FS-D	\$2399
Poly-Marble Basin-Top - Vanessa	CR120WS-V	\$2099	CR120FS-V	\$2399
Ceramic Basin-Top - Joli	CR120WS-J	\$2149	CR120FS-J	\$2469
Ceramic Basin-Top - Rotondo	CR120WS-R	\$2229	CR120FS-R	\$2549
Ceramic Basin-Top - Dolce Matte Black	CR120WS-DB	\$2799	CR120FS-DB	\$3099
Concrete Basin-Top - Satori	CR120WS-SC	\$3199	CR120FS-SC	\$3499
Standard Stone Top*	CR120WS-S	\$2499	CR120FS-S	\$2799
Premium Stone Top*	CR120WS-P	\$2949	CR120FS-P	\$3269
Australian Hardwood Top*	CR120WS-T	\$3379	CR120FS-T	\$3699

*Basin at additional cost.

FULL DEPTH	Wall-Hung		Floor Standing	
1500 mm Single Bowl or Double Bowl [^] Two Doors, Two Drawers				
VANITY INCLUDES	CODE	RRP	CODE	RRP
Ceramic Basin-Top - Dolce	CR150WS-D	\$3049	CR150FS-D	\$3469
Poly-Marble Basin-Top - Vanessa	CR150WS-V	\$2849	CR150FS-V	\$3269
Standard Stone Top*	CR150WS-S	\$3399	CR150FS-S	\$3799
Premium Stone Top*	CR150WS-P	\$3879	CR150FS-P	\$4299
Australian Hardwood Top*	CR150WS-T	\$4299	CR150FS-T	\$4699

*Basin at additional cost. [^]Excludes basin tops.

FULL DEPTH	Wall-Hung		Floor Standing	
1800 mm Single or Double Bowl Two Doors, Two Drawers				
VANITY INCLUDES	CODE	RRP	CODE	RRP
Poly-Marble Basin-Top - Vanessa	CR180WD-V	\$3199	CR180FD-V	\$3765
Standard Stone Top*	CR180WD-S	\$4199	CR180FD-S	\$4649
Premium Stone Top*	CR180WD-P	\$4679	CR180FD-P	\$5199
Australian Hardwood Top*	CR180WD-T	\$4999	CR180FD-T	\$5449

*Basin at additional cost.



Bayview 1500 mm Double Bowl Wall-Hung Vanity Cabinet, Stone Grey Matt;
Edge 350 mm Handles, Matte Black; Crystal Pure 1500 mm Stone Top • \$2949
Sarah Semi-Inset Ceramic Basins, Gloss White (including basin hole cuts) • \$199 each



Bayview 600 mm Wall-Hung Vanity Cabinet, Ultra White Matt;
Edge 200 mm Handle, Brushed Nickel; Roman Sand 600 mm Stone Top • \$1649 each
Reba Above Counter Ceramic Basin, Matte White • \$329 each



Bayview 900 mm Wall-Hung Vanity Cabinet, Ultra White Matt;
 Edge 350 mm Handle, Urban Brass; Crystal Pure 900 mm Stone Top • \$1899
 Eleanor Arch Above Counter Ceramic Basin, Gloss White • \$249

Bayview

VANITIES

Make a statement with our luxe Bayview vanity. With an added twist of vertical v-groove panelling, the visual impact adds definition and design to your bathroom.

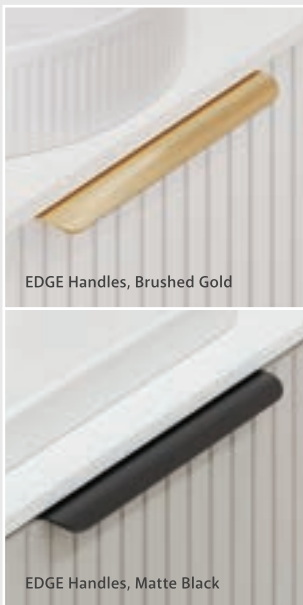

EDGE Handles, Brushed Gold

EDGE Handles, Matte Black

- Select from two thermolaminated finishes (see page 56)
- Vertical v-groove panelling
- 'Confident close' drawer damping system combines smooth, fast closing with late deceleration to provide a quiet landing on close
- Full extension runners allow easy access to the full depth of the drawer
- Fresh white interior
- Wall-hung
- EDGE blade-style handles in one of five finishes (required; included in price; see page 59)
- Made in Australia with FSC certified, E0 board

AVAILABLE WIDTHS





Choose from Ultra White Matt or Stone Grey Matt finishes on page 56.



Choose your EDGE blade-style handles (required) in one of five finishes on page 59.



Select from our extensive range of benchtops and basins on pages 60-69.



Order your dream vanity with our easy-to-use order forms on pages 70-72.

BAYVIEW, FULL DEPTH VANITIES

FULL DEPTH	Wall-Hung Only	
600 mm One Drawer		
VANITY INCLUDES	CODE	RRP
Ceramic Basin-Top - Dolce	B60W-D	\$1249
Poly-Marble Basin-Top - Vanessa	B60W-V	\$1449
Ceramic Basin-Top - Joli	B60W-J	\$1270
Ceramic Basin-Top - Rotondo	B60W-R	\$1449
Standard Stone Top*	B60W-S	\$1649
Premium Stone Top*	B60W-P	\$1839
Australian Hardwood Top*	B60W-T	\$2099

*Basin at additional cost.

FULL DEPTH	Wall-Hung Only	
750 mm One Drawer		
VANITY INCLUDES	CODE	RRP
Ceramic Basin-Top - Dolce	B75W-D	\$1349
Poly-Marble Basin-Top - Vanessa	B75W-V	\$1499
Ceramic Basin-Top - Joli	B75W-J	\$1370
Ceramic Basin-Top - Rotondo	B75W-R	\$1499
Ceramic Basin-Top - Dolce Matte Black	B75W-DB	\$1629
Concrete Basin-Top - Satori	B75W-SC	\$2149
Standard Stone Top*	B75W-S	\$1699
Premium Stone Top*	B75W-P	\$1889
Australian Hardwood Top*	B75W-T	\$2149

*Basin at additional cost.

FULL DEPTH	Wall-Hung Only	
900 mm One Drawer		
VANITY INCLUDES	CODE	RRP
Ceramic Basin-Top - Dolce	B90W-D	\$1399
Poly-Marble Basin-Top - Vanessa	B90W-V	\$1599
Ceramic Basin-Top - Joli	B90W-J	\$1549
Ceramic Basin-Top - Rotondo	B90W-R	\$1599
Ceramic Basin-Top - Dolce Matte Black	B90W-DB	\$1739
Concrete Basin-Top - Satori	B90W-SC	\$2399
Standard Stone Top*	B90W-S	\$1899
Premium Stone Top*	B90W-P	\$2139
Australian Hardwood Top*	B90W-T	\$2399

*Basin at additional cost.

BAYVIEW, FULL DEPTH VANITIES

FULL DEPTH	Wall-Hung Only	
1200 mm Single Bowl Two Drawers		
VANITY INCLUDES	CODE	RRP
Ceramic Basin-Top - Dolce	B120W-D	\$1549
Poly-Marble Basin-Top - Vanessa	B120W-V	\$1649
Ceramic Basin-Top - Joli	B120W-J	\$1599
Ceramic Basin-Top - Rotondo	B120W-R	\$1699
Ceramic Basin-Top - Dolce Matte Black	B120W-DB	\$2299
Concrete Basin-Top - Satori	B120W-SC	\$2979
Standard Stone Top*	B120W-S	\$2249
Premium Stone Top*	B120W-P	\$2699
Australian Hardwood Top*	B120W-T	\$2979

*Basin at additional cost.

FULL DEPTH	Wall-Hung Only	
1200 mm Double Bowl Two Drawers		
VANITY INCLUDES	CODE	RRP
Ceramic Basin-Top - Dolce	B120WD-D	\$1899
Standard Stone Top*	B120WD-S	\$2299
Premium Stone Top*	B120WD-P	\$2739
Australian Hardwood Top*	B120WD-T	\$3049

FULL DEPTH	Wall-Hung Only	
1500 mm Single Bowl Two Drawers		
VANITY INCLUDES	CODE	RRP
Ceramic Basin-Top - Dolce	B150WS-D	\$2699
Poly-Marble Basin-Top - Vanessa	B150WS-V	\$2499
Standard Stone Top*	B150WS-S	\$2799
Premium Stone Top*	B150WS-P	\$3199
Australian Hardwood Top*	B150WS-T	\$3599

*Basin at additional cost.

FULL DEPTH	Wall-Hung Only	
1500 mm Double Bowl Two Drawers		
VANITY INCLUDES	CODE	RRP
Ceramic Basin-Top - Dolce	B150WD-D	\$2899
Poly-Marble Basin-Top - Vanessa	B150WD-V	\$2649
Standard Stone Top*	B150WD-S	\$2949
Premium Stone Top*	B150WD-P	\$3349
Australian Hardwood Top*	B150WD-T	\$3749

FULL DEPTH	Wall-Hung Only	
1800 mm Single Bowl Two Drawers		
VANITY INCLUDES	CODE	RRP
Poly-Marble Basin-Top - Vanessa	B180WS-V	\$2799
Standard Stone Top*	B180WS-S	\$3099
Premium Stone Top*	B180WS-P	\$3599
Australian Hardwood Top*	B180WS-T	\$4099

*Basin at additional cost.

FULL DEPTH	Wall-Hung Only	
1800 mm Double Bowl Two Drawers		
VANITY INCLUDES	CODE	RRP
Poly-Marble Basin-Top - Vanessa	B180WD-V	\$3049
Standard Stone Top*	B180WD-S	\$3149
Premium Stone Top*	B180WD-P	\$3699
Australian Hardwood Top*	B180WD-T	\$4199



Carmen Door & Drawer 1500 mm Double Bowl Wall-Hung Vanity Cabinet, Artisan Beamwood;
Dolce 1500 mm Double Bowl Ceramic Basin-Top, Gloss White • \$1899



Carmen Door & Drawer 900 mm Wall-Hung Vanity Cabinet, Concrete Formwood;
Dolce 900 mm Offset, Ceramic Basin-Top, Left-Hand Bowl, Gloss White • \$849



Carmen Door & Drawer 1200 mm Floor Standing Vanity Cabinet, Aged Walnut;
 Urbane 128 mm Handles, Brushed Gold;
 Rotondo 1200 mm Ceramic Basin-Top, Gloss White • \$1249

Carmen

DOOR & DRAWER VANITIES

The classic and contemporary look of our Carmen vanity will complement any modern bathroom. The clean lines and functional storage make this vanity the perfect fit for everyday living.

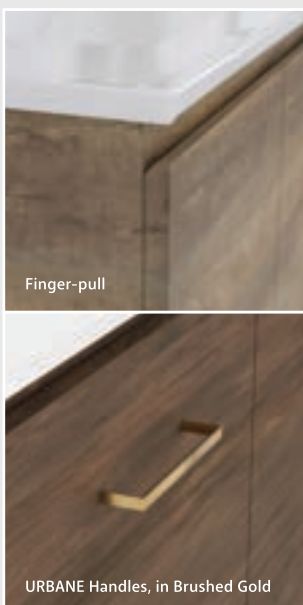

- Select from over 20 cabinet finishes (see pages 52-56)
- Horizontal direction for woodgrain finishes
- 'Confident close' drawer damping system combines smooth, fast closing with late deceleration to provide a quiet landing on close
- Full extension runners allow easy access to the full depth of the drawer
- Fresh white interior
- Wall-hung or floor standing
- Full depth (suits 465 mm tops) or ensuite depth (suits 365 mm tops) sizes
- Left- and right-hand drawers available (dependent on size)
- Your choice of bevelled finger-pull or handles (included in price; see pages 57-59)
- Made in Australia with FSC certified, E0 board

AVAILABLE WIDTHS

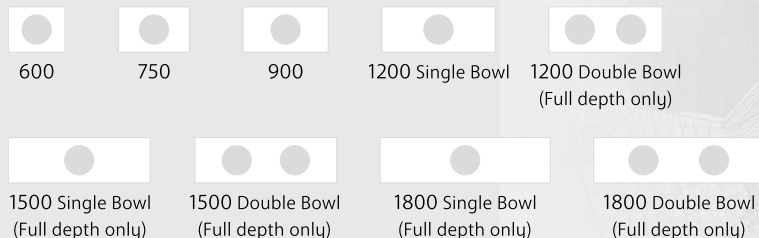

CARMEN, DOOR & DRAWER, FULL DEPTH VANITIES

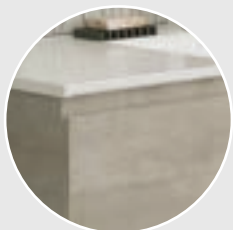

Bring out your creative side with over 20 cabinet finishes to choose from on pages 52-56.

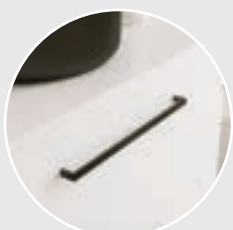

Choose a slimline finger-pull design, or accent your cabinetry with handles on pages 57-59.

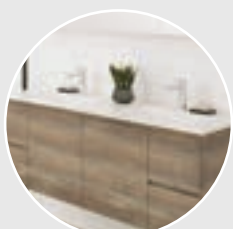

Select from our extensive range of benchtops and basins on pages 60-69.



Order your dream vanity with our easy-to-use order forms on pages 70-72.

FULL DEPTH	Wall-Hung		Floor Standing	
600 mm Two Doors				
VANITY INCLUDES	CODE	RRP	CODE	RRP
Ceramic Basin-Top - Dolce	C60W-D	\$659	C60F-D	\$699
Poly-Marble Basin-Top - Vanessa	C60W-V	\$810	C60F-V	\$849
Ceramic Basin-Top - Joli	C60W-J	\$680	C60F-J	\$720
Ceramic Basin-Top - Rotondo	C60W-R	\$699	C60F-R	\$739
Standard Stone Top*	C60W-S	\$1099	C60F-S	\$1149
Premium Stone Top*	C60W-P	\$1289	C60F-P	\$1339
Australian Hardwood Top*	C60W-T	\$1559	C60F-T	\$1649

*Basin at additional cost.

FULL DEPTH	Wall-Hung		Floor Standing	
750 mm One Door, Two Drawers (Left or Right Drawers)				
VANITY INCLUDES	CODE	RRP	CODE	RRP
Ceramic Basin-Top - Dolce	C75W-D	\$779	C75F-D	\$849
Poly-Marble Basin-Top - Vanessa	C75W-V	\$925	C75F-V	\$995
Ceramic Basin-Top - Joli	C75W-J	\$800	C75F-J	\$870
Ceramic Basin-Top - Rotondo	C75W-R	\$819	C75F-R	\$889
Ceramic Basin-Top - Dolce Matte Black	C75W-DB	\$1059	C75F-DB	\$1129
Concrete Basin-Top - Satori	C75W-SC	\$1729	C75F-SC	\$1829
Standard Stone Top*	C75W-S	\$1239	C75F-S	\$1339
Premium Stone Top*	C75W-P	\$1429	C75F-P	\$1529
Australian Hardwood Top*	C75W-T	\$1729	C75F-T	\$1829

*Basin at additional cost.

FULL DEPTH	Wall-Hung		Floor Standing	
900 mm One Door, Two Drawers (Left or Right Drawers)				
VANITY INCLUDES	CODE	RRP	CODE	RRP
Ceramic Basin-Top - Dolce	C90W-D	\$849	C90F-D	\$929
Poly-Marble Basin-Top - Vanessa	C90W-V	\$979	C90F-V	\$1075
Ceramic Basin-Top - Joli	C90W-J	\$870	C90F-J	\$950
Ceramic Basin-Top - Rotondo	C90W-R	\$889	C90F-R	\$969
Ceramic Basin-Top - Dolce Matte Black	C90W-DB	\$1189	C90F-DB	\$1269
Concrete Basin-Top - Satori	C90W-SC	\$1844	C90F-SC	\$1944
Standard Stone Top*	C90W-S	\$1299	C90F-S	\$1399
Premium Stone Top*	C90W-P	\$1544	C90F-P	\$1644
Australian Hardwood Top*	C90W-T	\$1844	C90F-T	\$1944

*Basin at additional cost.

CARMEN, DOOR & DRAWER, FULL DEPTH VANITIES

FULL DEPTH	Wall-Hung		Floor Standing	
1200 mm Single Bowl Two Doors, Two Drawers (Left or Right Drawers)				
VANITY INCLUDES	CODE	RRP	CODE	RRP
Ceramic Basin-Top - Dolce	C120W-D	\$999	C120F-D	\$1099
Poly-Marble Basin-Top - Vanessa	C120W-V	\$1149	C120F-V	\$1249
Ceramic Basin-Top - Joli	C120W-J	\$1049	C120F-J	\$1149
Ceramic Basin-Top - Rotondo	C120W-R	\$1039	C120F-R	\$1139
Ceramic Basin-Top - Dolce Matte Black	C120W-DB	\$1339	C120F-DB	\$1439
Concrete Basin-Top - Satori	C120W-SC	\$2249	C120F-SC	\$2299
Standard Stone Top*	C120W-S	\$1549	C120F-S	\$1599
Premium Stone Top*	C120W-P	\$1939	C120F-P	\$1989
Australian Hardwood Top*	C120W-T	\$2249	C120F-T	\$2299

*Basin at additional cost.

FULL DEPTH	Wall-Hung		Floor Standing	
1200 mm Double Bowl Two Doors, Two Drawers (Centre Drawers Only)				
VANITY INCLUDES	CODE	RRP	CODE	RRP
Ceramic Basin-Top - Dolce	C120WD-D	\$1329	C120FD-D	\$1429
Standard Stone Top*	C120WD-S	\$1699	C120FD-S	\$1799
Premium Stone Top*	C120WD-P	\$2089	C120FD-P	\$2189
Australian Hardwood Top*	C120WD-T	\$2399	C120FD-T	\$2499

*Basin at additional cost.

FULL DEPTH	Wall-Hung		Floor Standing	
1500 mm Single Bowl Two Doors, Four Drawers				
VANITY INCLUDES	CODE	RRP	CODE	RRP
Ceramic Basin-Top - Dolce	C150WS-D	\$1499	C150FS-D	\$1799
Poly-Marble Basin-Top - Vanessa	C150WS-V	\$1399	C150FS-V	\$1699
Standard Stone Top*	C150WS-S	\$2349	C150FS-S	\$2549
Premium Stone Top*	C150WS-P	\$2768	C150FS-P	\$2968
Australian Hardwood Top*	C150WS-T	\$3169	C150FS-T	\$3369

*Basin at additional cost.

Continued on next page

CARMEN, DOOR & DRAWER, FULL DEPTH VANITIES

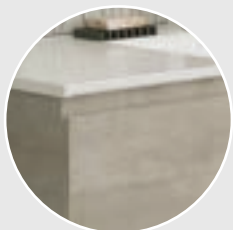

Bring out your creative side with over 20 cabinet finishes to choose from on pages 52-56.

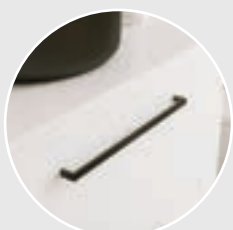

Choose a slimline finger-pull design, or accent your cabinetry with handles on pages 57-59.

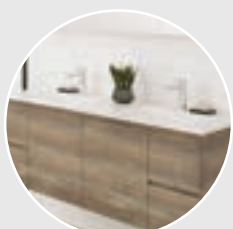

Select from our extensive range of benchtops and basins on pages 60-69.



Order your dream vanity with our easy-to-use order forms on pages 70-72.

FULL DEPTH	Wall-Hung		Floor Standing	
1500 mm Double Bowl Two Doors, Four Drawers				
VANITY INCLUDES	CODE	RRP	CODE	RRP
Ceramic Basin-Top - Dolce	C150WD-D	\$1899	C150FD-D	\$2099
Poly-Marble Basin-Top - Vanessa	C150WD-V	\$1799	C150FD-V	\$1999
Standard Stone Top*	C150WD-S	\$2399	C150FD-S	\$2549
Premium Stone Top*	C150WD-P	\$2829	C150FD-P	\$2969
Australian Hardwood Top*	C150WD-T	\$3229	C150FD-T	\$3369

*Basin at additional cost.

FULL DEPTH	Wall-Hung		Floor Standing	
1800 mm Single Bowl Two Doors, Four Drawers				
VANITY INCLUDES	CODE	RRP	CODE	RRP
Poly-Marble Basin-Top - Vanessa	C180WS-V	\$2099	C180FS-V	\$2199
Standard Stone Top*	C180WS-S	\$2799	C180FS-S	\$2949
Premium Stone Top*	C180WS-P	\$3349	C180FS-P	\$3498
Australian Hardwood Top*	C180WS-T	\$3749	C180FS-T	\$3898

*Basin at additional cost.

FULL DEPTH	Wall-Hung		Floor Standing	
1800 mm Double Bowl Two Doors, Four Drawers				
VANITY INCLUDES	CODE	RRP	CODE	RRP
Poly-Marble Basin-Top - Vanessa	C180WD-V	\$2099	C180FD-V	\$2199
Standard Stone Top*	C180WD-S	\$2899	C180FD-S	\$3049
Premium Stone Top*	C180WD-P	\$3448	C180FD-P	\$3598
Australian Hardwood Top*	C180WD-T	\$3848	C180FD-T	\$3998

*Basin at additional cost.

CARMEN, DOOR & DRAWER, ENSUITE DEPTH VANITIES

ENSUITE DEPTH	Wall-Hung		Floor Standing	
600 mm Two Doors				
VANITY INCLUDES	CODE	RRP	CODE	RRP
Ceramic Basin-Top - Delgado	CE60W-DT	\$599	CE60F-DT	\$649
Standard Stone Top*	CE60W-S	\$1049	CE60F-S	\$1099
Premium Stone Top*	CE60W-P	\$1239	CE60F-P	\$1299

*Basin at additional cost.

ENSUITE DEPTH	Wall-Hung		Floor Standing	
750 mm One Door, Two Drawers (Left or Right Drawers)				
VANITY INCLUDES	CODE	RRP	CODE	RRP
Ceramic Basin-Top - Delgado	CE75W-DT	\$699	CE75F-DT	\$789
Standard Stone Top*	CE75W-S	\$1149	CE75F-S	\$1249
Premium Stone Top*	CE75W-P	\$1399	CE75F-P	\$1499

*Basin at additional cost.

ENSUITE DEPTH	Wall-Hung		Floor Standing	
900 mm One Door, Two Drawers (Left or Right Drawers)				
VANITY INCLUDES	CODE	RRP	CODE	RRP
Ceramic Basin-Top - Delgado	CE90W-DT	\$789	CE90F-DT	\$849
Standard Stone Top*	CE90W-S	\$1249	CE90F-S	\$1299
Premium Stone Top*	CE90W-P	\$1499	CE90F-P	\$1549

*Basin at additional cost.

ENSUITE DEPTH	Wall-Hung		Floor Standing	
1200 mm Two Doors, Two Drawers (Left or Right Drawers)				
VANITY INCLUDES	CODE	RRP	CODE	RRP
Ceramic Basin-Top - Delgado	CE120W-DT	\$999	CE120F-DT	\$1049
Standard Stone Top*	CE120W-S	\$1449	CE120F-S	\$1599
Premium Stone Top*	CE120W-P	\$1799	CE120F-P	\$1949

*Basin at additional cost.



Carmen All Drawer 1800 mm Double Bowl Floor Standing Vanity Cabinet, Ultra White Matt;
Dallas 352 mm Handles, Matte Black; Crystal Pure 1800 mm Stone Top • \$3449
Reba Above Counter Ceramic Basins, Matte Black • \$329 each



Carmen All Drawer 900 mm Wall-Hung Vanity Cabinet, Notaio Walnut;
Dolce Matte Black 900 mm Ceramic Basin-Top • \$1689



Carmen All Drawer 1200 mm Double Bowl Wall-Hung Vanity Cabinet, Prime Oak;
 Roman Sand 1200 mm Stone Top • \$2199
 Koko 370 Above Counter Ceramic Basins, Gloss White • \$199 each

Carmen

ALL DRAWER VANITIES

The streamlined design of our Carmen All Drawer vanity adds a sleek, minimal aesthetic to your bathroom. Large soft-close drawers provide ample storage to keep your bathroom clean and organised. The simple, yet sophisticated design is the perfect canvas for incorporating colours and textures into your bathroom.

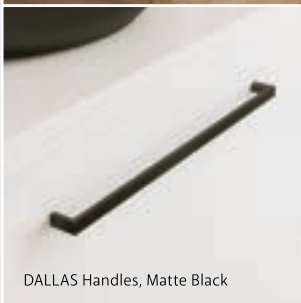
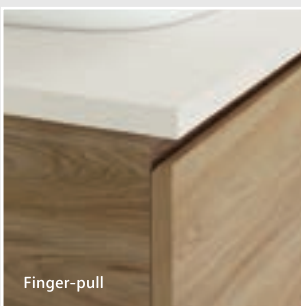

- Select from over 20 cabinet finishes (see pages 52-56)
- Horizontal direction for woodgrain finishes
- 'Confident close' drawer damping system combines smooth, fast closing with late deceleration to provide a quiet landing on close
- Full extension runners allow easy access to the full depth of the drawer
- Fresh white interior
- Wall-hung or floor standing
- Full depth (suits 465 mm tops) or ensuite depth (suits 365 mm tops) sizes
- Your choice of bevelled finger-pull or handles (included in price; see pages 57-59)
- Made in Australia with FSC certified, E0 board

AVAILABLE WIDTHS

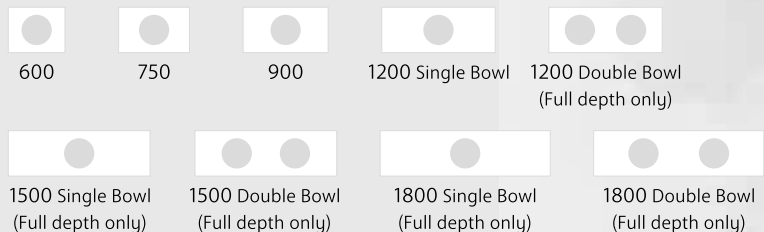

CARMEN, ALL DRAWER, FULL DEPTH VANITIES

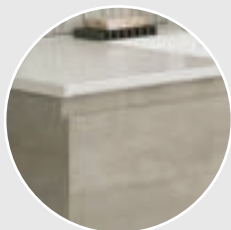

Bring out your creative side with over 20 cabinet finishes to choose from on pages 52-56.

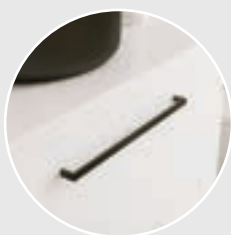

Choose a slimline finger-pull design, or accent your cabinetry with handles on pages 57-59.



Select from our extensive range of benchtops and basins on pages 60-69.



Order your dream vanity with our easy-to-use order forms on pages 70-72.

FULL DEPTH	Wall-Hung		Floor Standing	
600 mm Two Drawers				
VANITY INCLUDES	CODE	RRP	CODE	RRP
Ceramic Basin-Top - Dolce	CD60W-D	\$1199	CD60F-D	\$1299
Poly-Marble Basin-Top - Vanessa	CD60W-V	\$1349	CD60F-V	\$1449
Ceramic Basin-Top - Joli	CD60W-J	\$1220	CD60F-J	\$1320
Ceramic Basin-Top - Rotondo	CD60W-R	\$1239	CD60F-R	\$1339
Standard Stone Top*	CD60W-S	\$1549	CD60F-S	\$1649
Premium Stone Top*	CD60W-P	\$1739	CD60F-P	\$1839
Australian Hardwood Top*	CD60W-T	\$1999	CD60F-T	\$2099

*Basin at additional cost.

FULL DEPTH	Wall-Hung		Floor Standing	
750 mm Two Drawers				
VANITY INCLUDES	CODE	RRP	CODE	RRP
Ceramic Basin-Top - Dolce	CD75W-D	\$1299	CD75F-D	\$1399
Poly-Marble Basin-Top - Vanessa	CD75W-V	\$1449	CD75F-V	\$1549
Ceramic Basin-Top - Joli	CD75W-J	\$1325	CD75F-J	\$1425
Ceramic Basin-Top - Rotondo	CD75W-R	\$1339	CD75F-R	\$1439
Ceramic Basin-Top - Dolce Matte Black	CD75W-DB	\$1579	CD75F-DB	\$1629
Concrete Basin-Top - Satori	CD75W-SC	\$2089	CD75F-SC	\$2189
Standard Stone Top*	CD75W-S	\$1599	CD75F-S	\$1699
Premium Stone Top*	CD75W-P	\$1789	CD75F-P	\$1889
Australian Hardwood Top*	CD75W-T	\$2089	CD75F-T	\$2189

*Basin at additional cost.

FULL DEPTH	Wall-Hung		Floor Standing	
900 mm Two Drawers				
VANITY INCLUDES	CODE	RRP	CODE	RRP
Ceramic Basin-Top - Dolce	CD90W-D	\$1349	CD90F-D	\$1449
Poly-Marble Basin-Top - Vanessa	CD90W-V	\$1479	CD90F-V	\$1579
Ceramic Basin-Top - Joli	CD90W-J	\$1375	CD90F-J	\$1489
Ceramic Basin-Top - Rotondo	CD90W-R	\$1389	CD90F-R	\$1489
Ceramic Basin-Top - Dolce Matte Black	CD90W-DB	\$1689	CD90F-DB	\$1789
Concrete Basin-Top - Satori	CD90W-SC	\$2349	CD90F-SC	\$2449
Standard Stone Top*	CD90W-S	\$1799	CD90F-S	\$1899
Premium Stone Top*	CD90W-P	\$2039	CD90F-P	\$2139
Australian Hardwood Top*	CD90W-T	\$2349	CD90F-T	\$2449

*Basin at additional cost.

CARMEN, ALL DRAWER, FULL DEPTH VANITIES

FULL DEPTH	Wall-Hung		Floor Standing	
1200 mm Single Bowl Two Drawers				
VANITY INCLUDES	CODE	RRP	CODE	RRP
Ceramic Basin-Top - Dolce	CD120W-D	\$1499	CD120F-D	\$1599
Poly-Marble Basin-Top - Vanessa	CD120W-V	\$1599	CD120F-V	\$1649
Ceramic Basin-Top - Joli	CD120W-J	\$1549	CD120F-J	\$1649
Ceramic Basin-Top - Rotondo	CD120W-R	\$1539	CD120F-R	\$1639
Ceramic Basin-Top - Dolce Matte Black	CD120W-DB	\$2199	CD120F-DB	\$2299
Concrete Basin-Top - Satori	CD120W-SC	\$2899	CD120F-SC	\$2999
Standard Stone Top*	CD120W-S	\$2099	CD120F-S	\$2199
Premium Stone Top*	CD120W-P	\$2489	CD120F-P	\$2589
Australian Hardwood Top*	CD120W-T	\$2899	CD120F-T	\$2999

*Basin at additional cost.

FULL DEPTH	Wall-Hung		Floor Standing	
1200 mm Double Bowl Two Drawers				
VANITY INCLUDES	CODE	RRP	CODE	RRP
Ceramic Basin-Top - Dolce	CD120WD-D	\$1899	CD120FD-D	\$1999
Standard Stone Top*	CD120WD-S	\$2199	CD120FD-S	\$2299
Premium Stone Top*	CD120WD-P	\$2599	CD120FD-P	\$2699
Australian Hardwood Top*	CD120WD-T	\$2999	CD120FD-T	\$3099

*Basin at additional cost.

FULL DEPTH	Wall-Hung		Floor Standing	
1500 mm Single Bowl Four Drawers				
VANITY INCLUDES	CODE	RRP	CODE	RRP
Ceramic Basin-Top - Dolce	CD150WS-D	\$2349	CD150FS-D	\$2499
Poly-Marble Basin-Top - Vanessa	CD150WS-V	\$2549	CD150FS-V	\$2699
Standard Stone Top*	CD150WS-S	\$2899	CD150FS-S	\$2999
Premium Stone Top*	CD150WS-P	\$3299	CD150FS-P	\$3399
Australian Hardwood Top*	CD150WS-T	\$3699	CD150FS-T	\$3799

*Basin at additional cost.

Continued on next page

CARMEN, ALL DRAWER, FULL DEPTH VANITIES

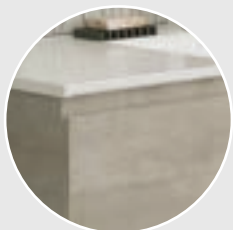

Bring out your creative side with over 20 cabinet finishes to choose from on pages 52-56.

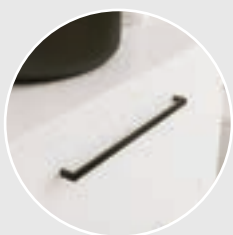

Choose a slimline finger-pull design, or accent your cabinetry with handles on pages 57-59.



Select from our extensive range of benchtops and basins on pages 60-69.



Order your dream vanity with our easy-to-use order forms on pages 70-72.

FULL DEPTH	Wall-Hung		Floor Standing	
1500 mm Double Bowl Four Drawers				
VANITY INCLUDES	CODE	RRP	CODE	RRP
Ceramic Basin-Top - Dolce	CD150WD-D	\$2699	CD150FD-D	\$2999
Poly-Marble Basin-Top - Vanessa	CD150WD-V	\$2499	CD150FD-V	\$2799
Standard Stone Top*	CD150WD-S	\$2799	CD150FD-S	\$3099
Premium Stone Top*	CD150WD-P	\$3199	CD150FD-P	\$3499
Australian Hardwood Top*	CD150WD-T	\$3599	CD150FD-T	\$3899

*Basin at additional cost.

FULL DEPTH	Wall-Hung		Floor Standing	
1800 mm Single Bowl Four Drawers				
VANITY INCLUDES	CODE	RRP	CODE	RRP
Poly-Marble Basin-Top - Vanessa	CD180WS-V	\$2899	CD180FS-V	\$3099
Standard Stone Top*	CD180WS-S	\$3249	CD180FS-S	\$3349
Premium Stone Top*	CD180WS-P	\$3798	CD180FS-P	\$3989
Australian Hardwood Top*	CD180WS-T	\$4298	CD180FS-T	\$4489

*Basin at additional cost.

FULL DEPTH	Wall-Hung		Floor Standing	
1800 mm Double Bowl Four Drawers				
VANITY INCLUDES	CODE	RRP	CODE	RRP
Poly-Marble Basin-Top - Vanessa	CD180WD-V	\$3049	CD180FD-V	\$3249
Standard Stone Top*	CD180WD-S	\$3349	CD180FD-S	\$3449
Premium Stone Top*	CD180WD-P	\$3898	CD180FD-P	\$3998
Australian Hardwood Top*	CD180WD-T	\$4398	CD180FD-T	\$4498

*Basin at additional cost.

CARMEN, ALL DRAWER, ENSUITE DEPTH VANITIES

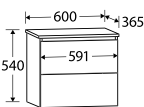
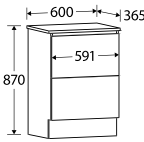
ENSUITE DEPTH	Wall-Hung		Floor Standing	
600 mm Two Drawers				
VANITY INCLUDES	CODE	RRP	CODE	RRP
Ceramic Basin-Top - Delgado	CED60W-DT	\$1099	CED60F-DT	\$1249
Standard Stone Top*	CED60W-S	\$1549	CED60F-S	\$1649
Premium Stone Top*	CED60W-P	\$1739	CED60F-P	\$1839

*Basin at additional cost.

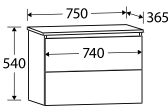
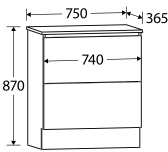
ENSUITE DEPTH	Wall-Hung		Floor Standing	
750 mm Two Drawers				
VANITY INCLUDES	CODE	RRP	CODE	RRP
Ceramic Basin-Top - Delgado	CED75W-DT	\$1199	CED75F-DT	\$1349
Standard Stone Top*	CED75W-S	\$1599	CED75F-S	\$1699
Premium Stone Top*	CED75W-P	\$1789	CED75F-P	\$1889

*Basin at additional cost.

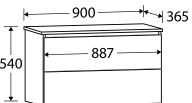
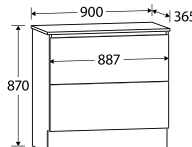
ENSUITE DEPTH	Wall-Hung		Floor Standing	
900 mm Two Drawers				
VANITY INCLUDES	CODE	RRP	CODE	RRP
Ceramic Basin-Top - Delgado	CED90W-DT	\$1249	CED90F-DT	\$1399
Standard Stone Top*	CED90W-S	\$1799	CED90F-S	\$1899
Premium Stone Top*	CED90W-P	\$2039	CED90F-P	\$2139

*Basin at additional cost.

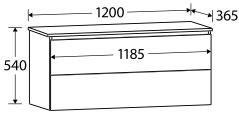
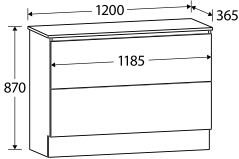
ENSUITE DEPTH	Wall-Hung		Floor Standing	
1200 mm Two Drawers				
VANITY INCLUDES	CODE	RRP	CODE	RRP
Ceramic Basin-Top - Delgado	CED120W-DT	\$1499	CED120F-DT	\$1599
Standard Stone Top*	CED120W-S	\$2099	CED120F-S	\$2199
Premium Stone Top*	CED120W-P	\$2489	CED120F-P	\$2589

*Basin at additional cost.



Newport Door & Drawer 1200 mm Floor Standing Vanity Cabinet, Stone Grey Matt;
 Hampton Pull Handles, Chrome; Bianco Marble 1200 mm Stone Top • \$1999
 Reba Semi-Inset Ceramic Basin, Gloss White (including basin hole cut) • \$339



Newport Door & Drawer 900 mm Wall-Hung Vanity Cabinet, Black Matt;
 Kaya Point Knobs, Brushed Nickel; Crystal Pure 900 mm Stone Top • \$1699
 Forma Above Counter Ceramic Basin, Gloss White • \$249



Newport Door & Drawer 1800 mm Double Bowl Wall-Hung Vanity Cabinet, Classic White Matt;
 Kaya Handles, Matte Black; Nero Vena 1800 mm Stone Top • \$3949
 Aluca Above Counter Ceramic Basins, Matte White • \$399 each

Newport

DOOR & DRAWER VANITIES

Tap into a classical style with our Newport vanities. You can create an authentic look by incorporating traditional elements that are both modern and timeless. The opulent design elevates the room, for a place of rest and relaxation. The optimised storage space keeps your counter top clear for styled arrangements.

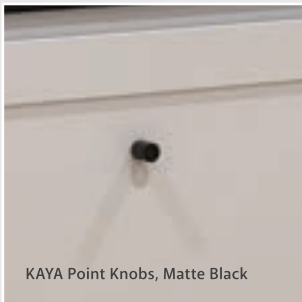

KAYA Point Knobs, Matte Black

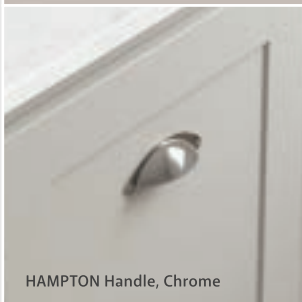

HAMPTON Handle, Chrome

- Select from three thermolaminated finishes (see page 56)
- Shaker-style door and drawer fronts
- ‘Confident close’ drawer damping system combines smooth, fast closing with late deceleration to provide a quiet landing on close
- Full extension runners allow easy access to the full depth of the drawer
- Fresh white interior
- Wall-hung or floor standing
- Full depth (suits 465 mm tops) or ensuite depth (suits 365 mm tops) sizes
- Left- and right-hand drawers available (dependent on size)
- Your choice of handles (required; included in price; see pages 57-59)
- Made in Australia with FSC certified, E0 board

AVAILABLE WIDTHS



NEWPORT, DOOR & DRAWER, FULL DEPTH VANITIES



Choose from 3 different, sleek and modern, matt cabinet finishes on page 56.

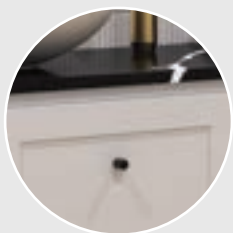

Customise by selecting from our extensive range of handles (required) on pages 57-59.

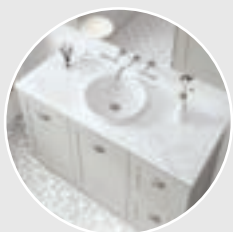

Select from our extensive range of benchtops and basins on pages 60-69.



Order your dream vanity with our easy-to-use order forms on pages 70-72.

FULL DEPTH	Wall-Hung		Floor Standing	
600 mm Two Doors				
VANITY INCLUDES	CODE	RRP	CODE	RRP
Ceramic Basin-Top - Dolce	N60W-D	\$949	N60F-D	\$999
Poly-Marble Basin-Top - Vanessa	N60W-V	\$1099	N60F-V	\$1149
Ceramic Basin-Top - Joli	N60W-J	\$970	N60F-J	\$1020
Ceramic Basin-Top - Rotondo	N60W-R	\$989	N60F-R	\$1039
Standard Stone Top*	N60W-S	\$1299	N60F-S	\$1349
Premium Stone Top*	N60W-P	\$1489	N60F-P	\$1539
Australian Hardwood Top*	N60W-T	\$1799	N60F-T	\$1849

*Basin at additional cost.

FULL DEPTH	Wall-Hung		Floor Standing	
750 mm One Door, Two Drawers (Left or Right Drawers)				
VANITY INCLUDES	CODE	RRP	CODE	RRP
Ceramic Basin-Top - Dolce	N75W-D	\$1149	N75F-D	\$1249
Poly-Marble Basin-Top - Vanessa	N75W-V	\$1199	N75F-V	\$1249
Ceramic Basin-Top - Joli	N75W-J	\$1175	N75F-J	\$1275
Ceramic Basin-Top - Rotondo	N75W-R	\$1189	N75F-R	\$1289
Ceramic Basin-Top - Dolce Matte Black	N75W-DB	\$1429	N75F-DB	\$1529
Concrete Basin-Top - Satori	N75W-SC	\$2039	N75F-SC	\$2139
Standard Stone Top*	N75W-S	\$1549	N75F-S	\$1649
Premium Stone Top*	N75W-P	\$1739	N75F-P	\$1839
Australian Hardwood Top*	N75W-T	\$2039	N75F-T	\$2139

*Basin at additional cost.

FULL DEPTH	Wall-Hung		Floor Standing	
900 mm One Door, Two Drawers (Left or Right Drawers)				
VANITY INCLUDES	CODE	RRP	CODE	RRP
Ceramic Basin-Top - Dolce	N90W-D	\$1199	N90F-D	\$1249
Poly-Marble Basin-Top - Vanessa	N90W-V	\$1299	N90F-V	\$1349
Ceramic Basin-Top - Joli	N90W-J	\$1239	N90F-J	\$1289
Ceramic Basin-Top - Rotondo	N90W-R	\$1239	N90F-R	\$1289
Ceramic Basin-Top - Dolce Matte Black	N90W-DB	\$1539	N90F-DB	\$1589
Concrete Basin-Top - Satori	N90W-SC	\$2249	N90F-SC	\$2299
Standard Stone Top*	N90W-S	\$1699	N90F-S	\$1749
Premium Stone Top*	N90W-P	\$1949	N90F-P	\$1999
Australian Hardwood Top*	N90W-T	\$2249	N90F-T	\$2299

*Basin at additional cost.

NEWPORT, DOOR & DRAWER, FULL DEPTH VANITIES

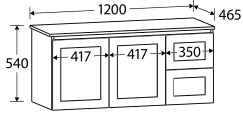
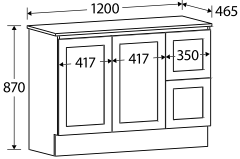
FULL DEPTH	Wall-Hung		Floor Standing	
1200 mm Single Bowl Two Doors, Two Drawers (Left or Right Drawers)				
VANITY INCLUDES	CODE	RRP	CODE	RRP
Ceramic Basin-Top - Dolce	N120W-D	\$1349	N120F-D	\$1449
Poly-Marble Basin-Top - Vanessa	N120W-V	\$1449	N120F-V	\$1549
Ceramic Basin-Top - Joli	N120W-J	\$1399	N120F-J	\$1499
Ceramic Basin-Top - Rotondo	N120W-R	\$1389	N120F-R	\$1489
Ceramic Basin-Top - Dolce Matte Black	N120W-DB	\$2049	N120F-DB	\$2149
Concrete Basin-Top - Satori	N120W-SC	\$2589	N120F-SC	\$2689
Standard Stone Top*	N120W-S	\$1899	N120F-S	\$1999
Premium Stone Top*	N120W-P	\$2289	N120F-P	\$2389
Australian Hardwood Top*	N120W-T	\$2589	N120F-T	\$2689

*Basin at additional cost.

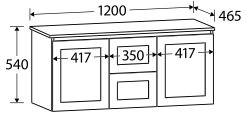
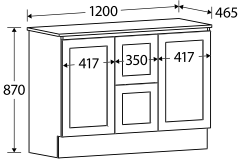
FULL DEPTH	Wall-Hung		Floor Standing	
1200 mm Double Bowl Two Doors, Two Drawers (Centre Drawers Only)				
VANITY INCLUDES	CODE	RRP	CODE	RRP
Ceramic Basin-Top - Dolce	N120WD-D	\$1649	N120FD-D	\$1749
Standard Stone Top*	N120WD-S	\$2489	N120FD-S	\$2589
Premium Stone Top*	N120WD-P	\$2679	N120FD-P	\$2779
Australian Hardwood Top*	N120WD-T	\$2979	N120F-T	\$3079

*Basin at additional cost.

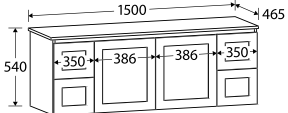
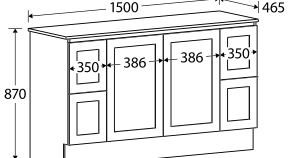
FULL DEPTH	Wall-Hung		Floor Standing	
1500 mm Single Bowl Two Doors, Four Drawers				
VANITY INCLUDES	CODE	RRP	CODE	RRP
Ceramic Basin-Top - Dolce	N150WS-D	\$1849	N150FS-D	\$1999
Poly-Marble Basin-Top - Vanessa	N150WS-V	\$1699	N150FS-V	\$1899
Standard Stone Top*	N150WS-S	\$2899	N150FS-S	\$2999
Premium Stone Top*	N150WS-P	\$3319	N150FS-P	\$3419
Australian Hardwood Top*	N150WS-T	\$3719	N150FS-T	\$3819

*Basin at additional cost.

Continued on next page

NEWPORT, DOOR & DRAWER, FULL DEPTH VANITIES



Choose from 3 different, sleek and modern, matt cabinet finishes on page 56.

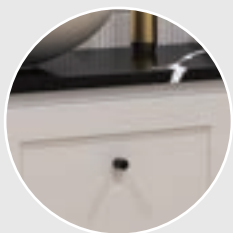

Customise by selecting from our extensive range of handles (required) on pages 57-59.

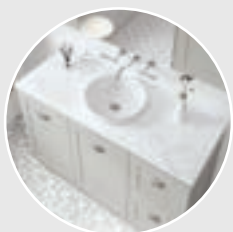

Select from our extensive range of benchtops and basins on pages 60-69.



Order your dream vanity with our easy-to-use order forms on pages 70-72.

FULL DEPTH	Wall-Hung		Floor Standing	
1500 mm Double Bowl Two Doors, Four Drawers				
VANITY INCLUDES	CODE	RRP	CODE	RRP
Ceramic Basin-Top - Dolce	N150WD-D	\$2399	N150FD-D	\$2699
Poly-Marble Basin-Top - Vanessa	N150WD-V	\$2199	N150FD-V	\$2499
Standard Stone Top*	N150WD-S	\$2999	N150FD-S	\$3199
Premium Stone Top*	N150WD-P	\$3499	N150FD-P	\$3599
Australian Hardwood Top*	N150WD-T	\$3899	N150FD-T	\$3999

*Basin at additional cost.

FULL DEPTH	Wall-Hung		Floor Standing	
1800 mm Single Bowl Two Doors, Four Drawers				
VANITY INCLUDES	CODE	RRP	CODE	RRP
Poly-Marble Basin-Top - Vanessa	N180WS-V	\$2299	N180FS-V	\$2399
Standard Stone Top*	N180WS-S	\$3199	N180FS-S	\$3349
Premium Stone Top*	N180WS-P	\$3749	N180FS-P	\$3899
Australian Hardwood Top*	N180WS-T	\$4249	N180FS-T	\$4399

*Basin at additional cost.

FULL DEPTH	Wall-Hung		Floor Standing	
1800 mm Double Bowl Two Doors, Four Drawers				
VANITY INCLUDES	CODE	RRP	CODE	RRP
Poly-Marble Basin-Top - Vanessa	N180WD-V	\$2399	N180FD-V	\$2699
Standard Stone Top*	N180WD-S	\$3399	N180FD-S	\$3549
Premium Stone Top*	N180WD-P	\$3949	N180FD-P	\$4099
Australian Hardwood Top*	N180WD-T	\$4449	N180FD-T	\$4599

*Basin at additional cost.

NEWPORT, DOOR & DRAWER, ENSUITE DEPTH VANITIES

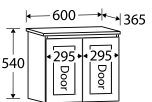
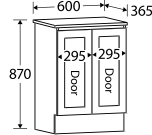
ENSUITE DEPTH	Wall-Hung		Floor Standing	
600 mm Two Doors				
VANITY INCLUDES	CODE	RRP	CODE	RRP
Ceramic Basin-Top - Delgado	NE60W-DT	\$949	NE60F-DT	\$999
Standard Stone Top*	NE60W-S	\$1249	NE60F-S	\$1299
Premium Stone Top*	NE60W-P	\$1449	NE60F-P	\$1499

*Basin at additional cost.

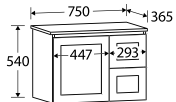
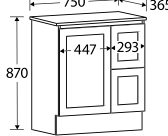
ENSUITE DEPTH	Wall-Hung		Floor Standing	
750 mm One Door, Two Drawers (Left or Right Drawers)				
VANITY INCLUDES	CODE	RRP	CODE	RRP
Ceramic Basin-Top - Delgado	NE75W-DT	\$1149	NE75F-DT	\$1249
Standard Stone Top*	NE75W-S	\$1499	NE75F-S	\$1599
Premium Stone Top*	NE75W-P	\$1699	NE75F-P	\$1799

*Basin at additional cost.

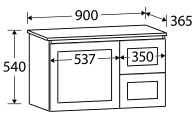
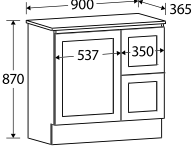
ENSUITE DEPTH	Wall-Hung		Floor Standing	
900 mm One Door, Two Drawers (Left or Right Drawers)				
VANITY INCLUDES	CODE	RRP	CODE	RRP
Ceramic Basin-Top - Delgado	NE90W-DT	\$1199	NE90F-DT	\$1249
Standard Stone Top*	NE90W-S	\$1649	NE90F-S	\$1699
Premium Stone Top*	NE90W-P	\$1899	NE90F-P	\$1949

*Basin at additional cost.

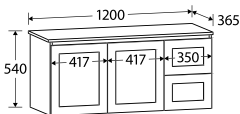
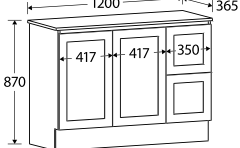
ENSUITE DEPTH	Wall-Hung		Floor Standing	
1200 mm Two Doors, Two Drawers (Left or Right Drawers)				
VANITY INCLUDES	CODE	RRP	CODE	RRP
Ceramic Basin-Top - Delgado	NE120W-DT	\$1449	NE120F-DT	\$1649
Standard Stone Top*	NE120W-S	\$1849	NE120F-S	\$1899
Premium Stone Top*	NE120W-P	\$2239	NE120F-P	\$2289

*Basin at additional cost.



Newport All Drawer 900 mm Floor Standing Vanity Cabinet, Classic White Matt;
Hampton Pull Handles, Brushed Nickel; Calacatta Marble 900 mm Stone Top • \$2499
Classique 420 Above Counter Cast Stone Basin, Matte White • \$399



Newport All Drawer 1200 mm Double Bowl Floor Standing Vanity Cabinet, Stone Grey Matt;
Urbane 320 mm Handles, Matte Black; Dolce 1200 mm Double Bowl Ceramic Basin-Top, Gloss White • \$2249



Newport All Drawer 1800 mm Double Bowl Wall-Hung Vanity Cabinet, Black Matt; Urbane 320 mm Handles, Brushed Gold; Crystal Pure 1800 mm Stone Top • \$3749
Reba Above Counter Ceramic Basins, Matte White • \$329 each

Newport

ALL DRAWER VANITIES

Add an extra touch of luxury with our elegant and chic Newport All Drawer vanity. The stunning shaker profile will create a focal point in your bathroom and become a beautiful accent piece.



HAMPTON Handle, Brushed Nickel



URBANE Handle, Matte Black

- Select from three thermolaminated finishes (see page 56)
- Shaker-style drawer fronts
- ‘Confident close’ drawer damping system combines smooth, fast closing with late deceleration to provide a quiet landing on close
- Full extension runners allow easy access to the full depth of the drawer
- Fresh white interior
- Wall-hung or floor standing
- Full depth (suits 465 mm tops) or ensuite depth (suits 365 mm tops) sizes
- Your choice of handles (required; included in price; see pages 57-59)
- Made in Australia with FSC certified, E0 board

AVAILABLE WIDTHS



600



750



900



1200 Single Bowl



1200 Double Bowl
(Full depth only)



1500 Single Bowl
(Full depth only)



1500 Double Bowl
(Full depth only)



1800 Single Bowl
(Full depth only)

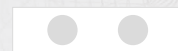

1800 Double Bowl
(Full depth only)

NEWPORT, ALL DRAWER, FULL DEPTH VANITIES

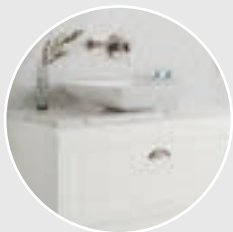

Choose from 3 different, sleek and modern, matt cabinet finishes on page 56.

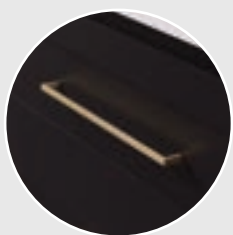

Customise by selecting from our extensive range of handles (required) on pages 57-59.



Select from our extensive range of benchtops and basins on pages 60-69.



Order your dream vanity with our easy-to-use order forms on pages 70-72.

FULL DEPTH	Wall-Hung		Floor Standing	
600 mm Two Drawers				
VANITY INCLUDES	CODE	RRP	CODE	RRP
Ceramic Basin-Top - Dolce	ND60W-D	\$1449	ND60F-D	\$1599
Poly-Marble Basin-Top - Vanessa	ND60W-V	\$1649	ND60F-V	\$1799
Ceramic Basin-Top - Joli	ND60W-J	\$1470	ND60F-J	\$1620
Ceramic Basin-Top - Rotondo	ND60W-R	\$1489	ND60F-R	\$1639
Standard Stone Top*	ND60W-S	\$1849	ND60F-S	\$1899
Premium Stone Top*	ND60W-P	\$2039	ND60F-P	\$2089
Australian Hardwood Top*	ND60W-T	\$2299	ND60F-T	\$2379

*Basin at additional cost.

FULL DEPTH	Wall-Hung		Floor Standing	
750 mm Two Drawers				
VANITY INCLUDES	CODE	RRP	CODE	RRP
Ceramic Basin-Top - Dolce	ND75W-D	\$1549	ND75F-D	\$1699
Poly-Marble Basin-Top - Vanessa	ND75W-V	\$1699	ND75F-V	\$1849
Ceramic Basin-Top - Joli	ND75W-J	\$1475	ND75F-J	\$1625
Ceramic Basin-Top - Rotondo	ND75W-R	\$1589	ND75F-R	\$1739
Ceramic Basin-Top - Dolce Matte Black	ND75W-DB	\$1729	ND75F-DB	\$1879
Concrete Basin-Top - Satori	ND75W-SC	\$2389	ND75F-SC	\$2489
Standard Stone Top*	ND75W-S	\$1899	ND75F-S	\$1999
Premium Stone Top*	ND75W-P	\$2089	ND75F-P	\$2189
Australian Hardwood Top*	ND75W-T	\$2389	ND75F-T	\$2489

*Basin at additional cost.

FULL DEPTH	Wall-Hung		Floor Standing	
900 mm Two Drawers				
VANITY INCLUDES	CODE	RRP	CODE	RRP
Ceramic Basin-Top - Dolce	ND90W-D	\$1599	ND90F-D	\$1699
Poly-Marble Basin-Top - Vanessa	ND90W-V	\$1799	ND90F-V	\$1899
Ceramic Basin-Top - Joli	ND90W-J	\$1749	ND90F-J	\$1849
Ceramic Basin-Top - Rotondo	ND90W-R	\$1639	ND90F-R	\$1739
Ceramic Basin-Top - Dolce Matte Black	ND90W-DB	\$1939	ND90F-DB	\$2039
Concrete Basin-Top - Satori	ND90W-SC	\$2639	ND90F-SC	\$2799
Standard Stone Top*	ND90W-S	\$2099	ND90F-S	\$2249
Premium Stone Top*	ND90W-P	\$2339	ND90F-P	\$2499
Australian Hardwood Top*	ND90W-T	\$2639	ND90F-T	\$2799

*Basin at additional cost.

NEWPORT, ALL DRAWER, FULL DEPTH VANITIES

FULL DEPTH	Wall-Hung		Floor Standing	
1200 mm Single Bowl Two Drawers				
VANITY INCLUDES	CODE	RRP	CODE	RRP
Ceramic Basin-Top - Dolce	ND120W-D	\$1799	ND120F-D	\$1899
Poly-Marble Basin-Top - Vanessa	ND120W-V	\$1949	ND120F-V	\$2199
Ceramic Basin-Top - Joli	ND120W-J	\$1849	ND120F-J	\$1949
Ceramic Basin-Top - Rotondo	ND120W-R	\$1839	ND120F-R	\$1939
Ceramic Basin-Top - Dolce Matte Black	ND120W-DB	\$2499	ND120F-DB	\$2599
Concrete Basin-Top - Satori	ND120W-SC	\$3199	ND90F-SC	\$3299
Standard Stone Top*	ND120W-S	\$2499	ND120F-S	\$2599
Premium Stone Top*	ND120W-P	\$2899	ND120F-P	\$2999
Australian Hardwood Top*	ND120W-T	\$3199	ND120F-T	\$3299

*Basin at additional cost.

FULL DEPTH	Wall-Hung		Floor Standing	
1200 mm Double Bowl Two Drawers				
VANITY INCLUDES	CODE	RRP	CODE	RRP
Ceramic Basin-Top - Dolce	ND120WD-D	\$2099	ND120FD-D	\$2249
Standard Stone Top*	ND120WD-S	\$2549	ND120FD-S	\$2649
Premium Stone Top*	ND120WD-P	\$2939	ND120FD-P	\$3039
Australian Hardwood Top*	ND120WD-T	\$3239	ND120FD-T	\$3339

*Basin at additional cost.

FULL DEPTH	Wall-Hung		Floor Standing	
1500 mm Single Bowl Four Drawers				
VANITY INCLUDES	CODE	RRP	CODE	RRP
Poly-Marble Basin-Top - Vanessa	ND150WS-V	\$2699	ND150FS-V	\$2799
Ceramic Basin-Top - Dolce	ND150WS-D	\$2899	ND150FS-D	\$2999
Standard Stone Top*	ND150WS-S	\$3149	ND150FS-S	\$3299
Premium Stone Top*	ND150WS-P	\$3569	ND150FS-P	\$3699
Australian Hardwood Top*	ND150WS-T	\$3969	ND150FS-T	\$4099

*Basin at additional cost.

Continued on next page

NEWPORT, ALL DRAWER, FULL DEPTH VANITIES

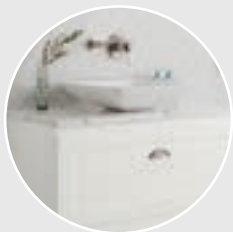

Choose from 3 different, sleek and modern, matt cabinet finishes on page 56.

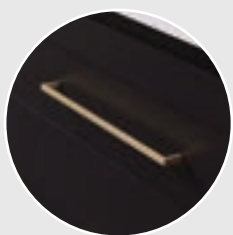

Customise by selecting from our extensive range of handles (required) on pages 57-59.



Select from our extensive range of benchtops and basins on pages 60-69.



Order your dream vanity with our easy-to-use order forms on pages 70-72.

FULL DEPTH	Wall-Hung		Floor Standing	
1500 mm Double Bowl Four Drawers				
VANITY INCLUDES	CODE	RRP	CODE	RRP
Ceramic Basin-Top - Dolce	ND150WD-D	\$3299	ND150FD-D	\$3499
Poly-Marble Basin-Top - Vanessa	ND150WD-V	\$3049	ND150FD-V	\$3199
Standard Stone Top*	ND150WD-S	\$3349	ND150FD-S	\$3499
Premium Stone Top*	ND150WD-P	\$3749	ND150FD-P	\$3899
Australian Hardwood Top*	ND150WD-T	\$4149	ND150FD-T	\$4299

*Basin at additional cost.

FULL DEPTH	Wall-Hung		Floor Standing	
1800 mm Single Bowl Four Drawers				
VANITY INCLUDES	CODE	RRP	CODE	RRP
Poly-Marble Basin-Top - Vanessa	ND180WS-V	\$3199	ND180FS-V	\$3399
Standard Stone Top*	ND180WS-S	\$3499	ND180FS-S	\$3699
Premium Stone Top*	ND180WS-P	\$3999	ND180FS-P	\$4199
Australian Hardwood Top*	ND180WS-T	\$4499	ND180FS-T	\$4699

*Basin at additional cost.

FULL DEPTH	Wall-Hung		Floor Standing	
1800 mm Double Bowl Four Drawers				
VANITY INCLUDES	CODE	RRP	CODE	RRP
Poly-Marble Basin-Top - Vanessa	ND180WD-V	\$3449	ND180FD-V	\$3699
Standard Stone Top*	ND180WD-S	\$3749	ND180FD-S	\$3899
Premium Stone Top*	ND180WD-P	\$4299	ND180FD-P	\$4399
Australian Hardwood Top*	ND180WD-T	\$4799	ND180FD-T	\$4899

*Basin at additional cost.

NEWPORT, ALL DRAWER, ENSUITE DEPTH VANITIES

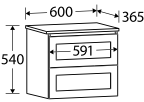
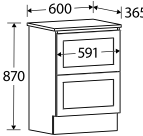
ENSUITE DEPTH	Wall-Hung		Floor Standing	
600 mm Two Drawers				
VANITY INCLUDES	CODE	RRP	CODE	RRP
Ceramic Basin-Top - Delgado	NED60W-DT	\$1449	NED60F-DT	\$1599
Standard Stone Top*	NED60W-S	\$1849	NED60F-S	\$1899
Premium Stone Top*	NED60W-P	\$2039	NED60F-P	\$2089

*Basin at additional cost.

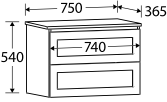
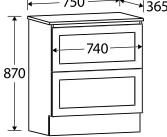
ENSUITE DEPTH	Wall-Hung		Floor Standing	
750 mm Two Drawers				
VANITY INCLUDES	CODE	RRP	CODE	RRP
Ceramic Basin-Top - Delgado	NED75W-DT	\$1549	NED75F-DT	\$1699
Standard Stone Top*	NED75W-S	\$1899	NED75F-S	\$1999
Premium Stone Top*	NED75W-P	\$2089	NED75F-P	\$2189

*Basin at additional cost.

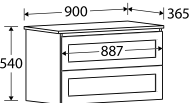
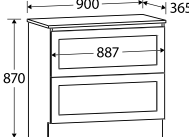
ENSUITE DEPTH	Wall-Hung		Floor Standing	
900 mm Two Drawers				
VANITY INCLUDES	CODE	RRP	CODE	RRP
Ceramic Basin-Top - Delgado	NED90W-DT	\$1599	NED90F-DT	\$1699
Standard Stone Top*	NED90W-S	\$2099	NED90F-S	\$2249
Premium Stone Top*	NED90W-P	\$2339	NED90F-P	\$2499

*Basin at additional cost.

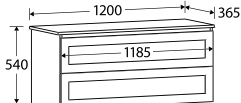
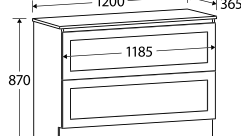
ENSUITE DEPTH	Wall-Hung		Floor Standing	
1200 mm Two Drawers				
VANITY INCLUDES	CODE	RRP	CODE	RRP
Ceramic Basin-Top - Delgado	NED120W-DT	\$1799	NED120F-DT	\$1899
Standard Stone Top*	NED120W-S	\$2499	NED120F-S	\$2599
Premium Stone Top*	NED120W-P	\$2899	NED120F-P	\$2999

*Basin at additional cost.



Riley 450 mm Floor Standing Ensuite Vanity Cabinet, Seasoned Oak; Denzel Ceramic Basin Top • \$829

Riley ENSUITE VANITIES

The slim profile of the Riley vanity makes it the perfect solution for smaller bathrooms and ensuites. Choose from our range of stylish woodgrain finishes for a modern and textured look.

- Select from over 20 woodgrain cabinet finishes (see pages 52-55)
- Horizontal woodgrain direction
- Soft close door
- Matching interior and exterior finish
- Wall-hung or floor standing
- Slim ensuite depth (250 mm including basin-top)
- Left- or right-hand door opening available
- Bevelled finger-pull channel
- Made in Australia with FSC certified, E0 board

SLIM ENSUITE DEPTH	Wall-Hung	
450 mm One Door		
VANITY INCLUDES	CODE	RRP
Ceramic Basin-Top - Denzel	R45W-Z	\$749
Poly-Marble Basin-Top - Ralph	R45W-R	\$699

SLIM ENSUITE DEPTH	Floor Standing	
450 mm One Door		
VANITY INCLUDES	CODE	RRP
Ceramic Basin-Top - Denzel	R45F-Z	\$829
Poly-Marble Basin-Top - Ralph	R45F-R	\$780



Kassi 750 mm Floor Standing Ensuite Depth Vanity Cabinet, Notaio Walnut;
Kaya Point Knobs, Gun Metal; Roman Sand 750 mm Stone Top • \$1955
Bahama Above Counter Cast Stone Basin, Matte White • \$399



Aluca 600mm Mirror • \$399

Aluca

MIRRORS

Our Australian made mirrors are made to exacting standards and are available in various sizes to suit any bathroom layout. The split batten installation design makes it easy to achieve a perfectly level mirror during installation.

- 6 mm thick glass with polished pencil edge design, pre-glued onto 16 mm thick backing board
- Select from five different sizes to suit your space
- White board edging as standard; edging to match your vanity available on request
- Copper free to prevent corrosion
- Split batten mounting for easy installation
- Made in Australia with FSC certified, E0 board
- 1-year warranty

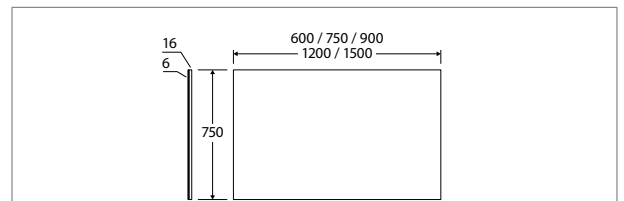

SIZE	CODE	RRP
600 mm	M600	\$399
750 mm	M750	\$449
900 mm	M900	\$499
1200 mm	M1200	\$629
1500 mm	M1500	\$899



White Board Edging (Standard)

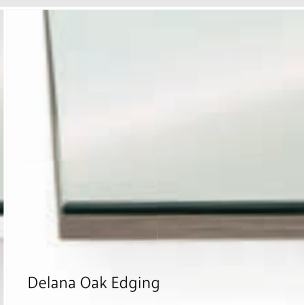

Delana Oak Edging

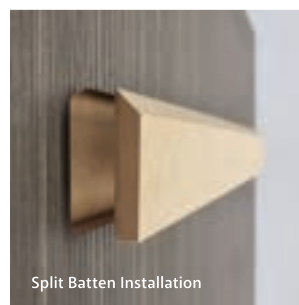

Split Batten Installation

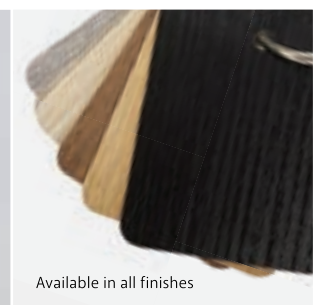

Available in all finishes



Aluca 1200mm Framed Mirror, Prime Oak • \$629

Aluca

FRAMED MIRRORS

If you're looking to add an extra bit of flair and refinement to your bathroom design, try our Aluca range of framed mirrors.

- 6 mm thick glass with polished pencil edge design, pre-glued onto 16 mm thick backing board
- Landscape orientation as standard (portrait orientation available on request)
- Select from over 20 board finishes to match your vanity (see pages 52-56)
- Horizontal direction for woodgrain finishes as standard (vertical direction available on request)
- Copper free to prevent corrosion
- Split batten mounting for easy installation
- Made in Australia with FSC certified, E0 board
- 1-year warranty

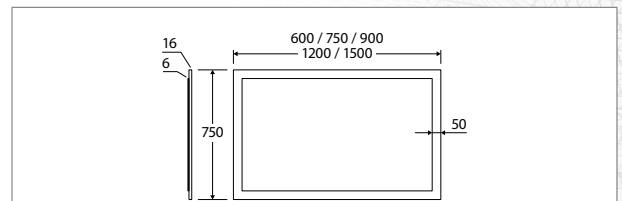

SIZE	CODE	RRP
600 mm	CFM600	\$399
750 mm	CFM750	\$449
900 mm	CFM900	\$499
1200 mm	CFM1200	\$629
1500 mm	CFM1500	\$899

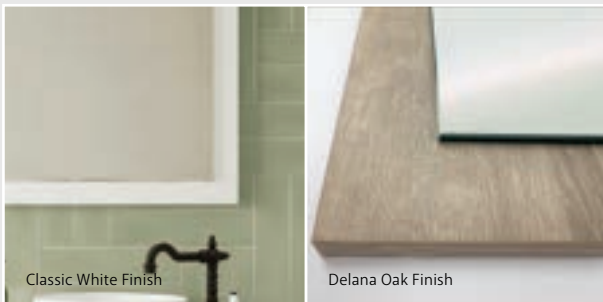

Classic White Finish

Delana Oak Finish



Split Batten Installation

Available in all finishes

Aluca 1200 mm Mirror Cabinet,
Aged Walnut • \$999



Aluca MIRROR CABINETS

Our Aluca Mirror Cabinets are a functional storage solution for your bathroom. Match the finish of the mirror cabinet to your vanity for a considered bathroom design.

- Select from over 20 finishes to match your vanity (see pages 52-56)
- For woodgrain finishes: interior with horizontal direction; sides with vertical direction
- Matching interior and exterior finish
- Soft close doors
- Two adjustable internal board shelves
- Can be installed for left- or right-side hinges
- Made in Australia with FSC certified, E0 board

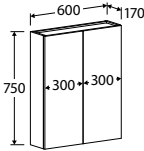
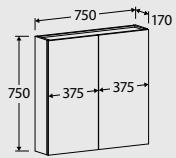
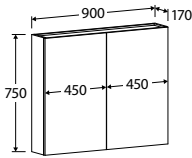
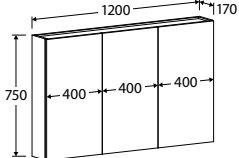
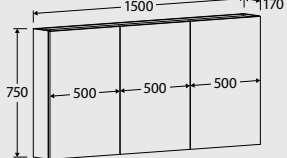
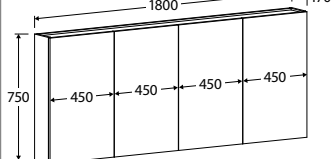

Internal Shelves

CABINET	CODE	RRP
600 mm Two Mirror Doors		
	CMC600	\$635
750 mm Two Mirror Doors		
	CMC750	\$679
900 mm Two Mirror Doors		
	CMC900	\$759
1200 mm Three Mirror Doors		
	CMC1200	\$999
1500 mm Three Mirror Doors		
	CMC1500	\$1149
1800 mm Four Mirror Doors		
	CMC1800	\$1349



Available in all finishes



Aluca

DISPLAY SHELF MIRROR CABINETS

With an integrated display shelf, you can decorate or store easy-to-reach items for a clutter-free bathroom.

- Integrated display shelf for styling or easy access storage
- Select from over 20 finishes to match your vanity (see pages 52-56)
- For woodgrain finishes: shelf and interior with horizontal direction; sides with vertical direction
- Matching interior and exterior finish
- Soft close doors
- Two adjustable internal board shelves
- Made in Australia with FSC certified, E0 board

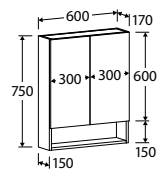
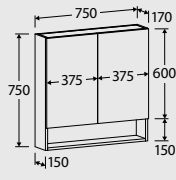
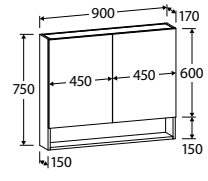
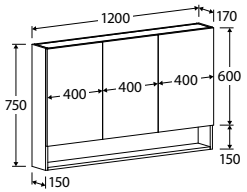
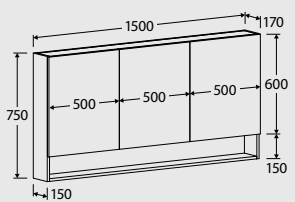
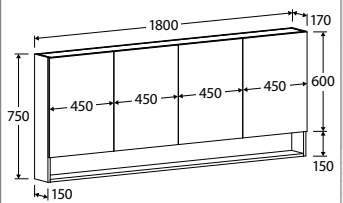

CABINET	CODE	RRP
600 mm Two Mirror Doors		
	DMC600	\$759
750 mm Two Mirror Doors		
	DMC750	\$889
900 mm Two Mirror Doors		
	DMC900	\$949
1200 mm Three Mirror Doors		
	DMC1200	\$1149
1500 mm Three Mirror Doors		
	DMC1500	\$1269
1800 mm Four Mirror Doors		
	DMC1800	\$1359



Newport Wall Cabinets, Black Matt;
Mila Shaker Knobs, in Urban Brass
(Custom handle positions)



Wall CABINETS

Our Wall Cabinets are a creative and smart solution for storage in smaller bathrooms. Incorporate a wall cabinet into your design, either as a standalone piece, or combined with a mirror or mirror cabinet for a tiered look.

- Select from Carmen, Newport or Bayview designs
- Various finishes available depending on design (see pages 52-56)
- For woodgrain finishes: door and interior with horizontal direction; sides with vertical direction
- Matching interior and exterior finish
- Soft close doors
- Two adjustable internal shelves
- Can be installed for left- or right-side hinges
- Can be used with or without handles (included in price)
- Made in Australia with FSC certified, E0 board



CABINET	CODE	RRP
Carmen One Door		
	CWC300	\$499
Newport One Door		
	NWC300	\$549
Bayview One Door		
	BWC300	\$549

Newport 1200 mm Combination Cabinet,
Stone Grey Matt • \$1733



Combination

CABINETS

Combine the best of both worlds by pairing a functional mirror cabinet with a wall cabinet that matches your vanity. Choose a combination with one, or two, 300 mm wall cabinets, to create a unique look for your bathroom.

- Select from Carmen, Newport or Bayview designs
- Available in 900 mm or 1200 mm overall widths only
- Various finishes available depending on design (see pages 52-56)
- For woodgrain finishes: door and interior with horizontal direction; sides with vertical direction
- Matching interior and exterior finish
- Soft close doors
- Mirror cabinet (600 mm) features a single door design
- Two adjustable internal shelves in each cabinet
- Can be installed for left- or right-side hinges
- Can be used with or without handles (included in price)
- Made in Australia with FSC certified, E0 board

CABINET CONFIGURATION	CODE	RRP	CABINET CONFIGURATION	CODE	RRP
Carmen 900 mm One Mirror Door, One Cabinet Door			Carmen 1200 mm One Mirror Door, Two Cabinet Doors		
	CCMC900	\$1134		CCMC1200	\$1633
Newport 900 mm One Mirror Door, One Cabinet Door			Newport 1200 mm One Mirror Door, Two Cabinet Doors		
	NCMC900	\$1184		NCMC1200	\$1733
Bayview 900 mm One Mirror Door, One Cabinet Door			Bayview 1200 mm One Mirror Door, Two Cabinet Doors		
	BCMC900	\$1184		BCMC1200	\$1733

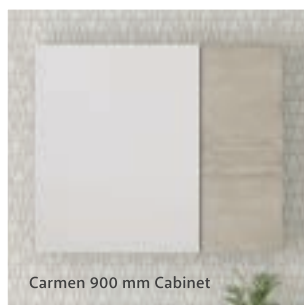

Carmen 900 mm Cabinet

Carmen Floor Standing
Tallboy, Notaio Walnut • \$1399



Tallboy

CABINETS

Our Tallboy range is designed to match our vanities, creating a cohesive and functional storage solution for your bathroom.

- Select from Carmen, Newport or Bayview designs
- Various finishes available depending on design (see pages 52-56)
- For woodgrain finishes: door with horizontal direction; sides and interior with vertical direction
- Soft close doors
- Fresh white interior
- Four adjustable internal shelves (fixed middle shelf)
- Door opening:
 - Carmen (Ultra White Matt): Bevelled finger-pull only; handles optional (included in price) but doors will retain bevelled finger-pull design
 - Carmen (All Other Colours): Option of bevelled finger-pull or square profile door with handles (included in price)
 - Newport: Requires handles (included in price)
 - Bayview: Moulded groove finger-pull; handles optional (included in price)
- Wall-hung or floor standing
- Made in Australia with FSC certified, E0 board



CABINET STYLE	Wall-Hung		Floor Standing	
	CODE	RRP	CODE	RRP
Carmen Two Doors (Finger-pull)				
	CTBW	\$1049	CTBF	\$1399
Newport Two Doors (Handles required)				
	NTBW	\$1399	NTBF	\$1649
Bayview Two Doors (Finger-pull)				
	BTBW	\$1399	BTBF	\$1649

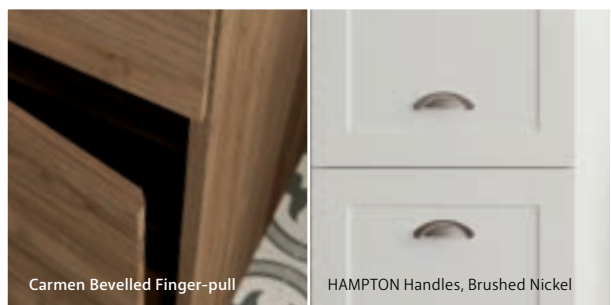



Newport All Drawer 900 mm Floor Standing Vanity Cabinet, Classic White Matt;
Hampton Pull Handles, Brushed Nickel; Calacatta Marble 900 mm Stone Top • \$2499
Classique 420 Above Counter Cast Stone Basin, Matte White • \$399
Newport Floor Standing Tallboy, Classic White Matt; Hampton Pull Handles, Brushed Nickel • \$1649

STANDARD
Woodgrain
 CABINET FINISHES

Select any of the following cabinet finishes at no extra charge. We highly recommend checking physical colour samples prior to placing your order.

Available on selected cabinets: **Kassi, Cierra, Carmen, Riley.**

Non-Standard Cabinet Finish Options (Additional Charge)		
FINISH OPTIONS	CODE	RRP
LAMINEX Melamine	SPLFINISH-LMX	\$235
POLYTEC Melamine	SPLFINISH-PLY	\$235
All Other Non-Standard Melamine	—	POA



LAMINEX
 Seasoned Oak
 Chalk (Textured)

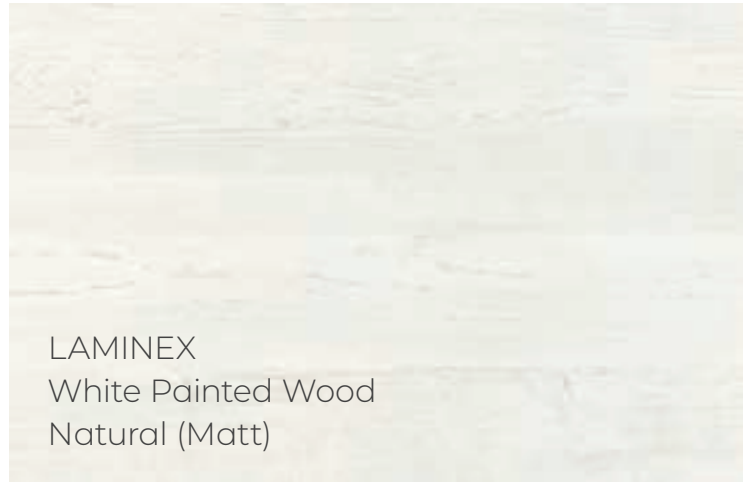

LAMINEX
 White Painted Wood
 Natural (Matt)

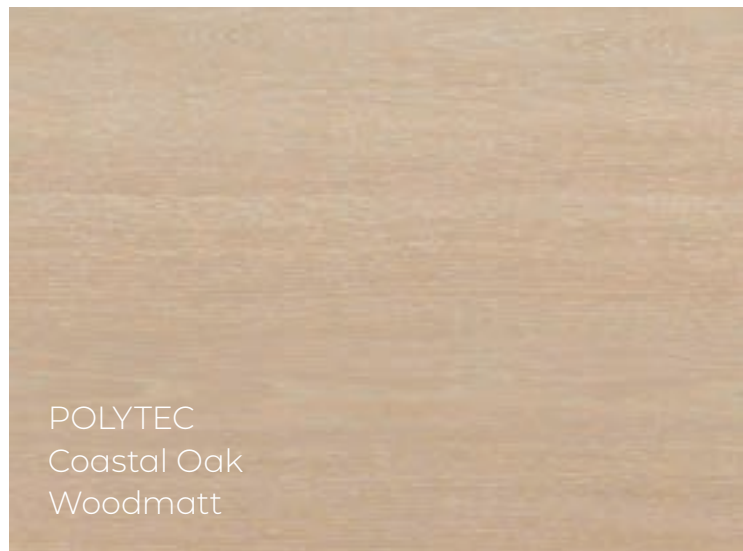

POLYTEC
 Coastal Oak
 Woodmatt



POLYTEC
 Angora Oak
 Woodmatt (Textured)



POLYTEC
 Tasmanian Oak
 Woodmatt (Textured)

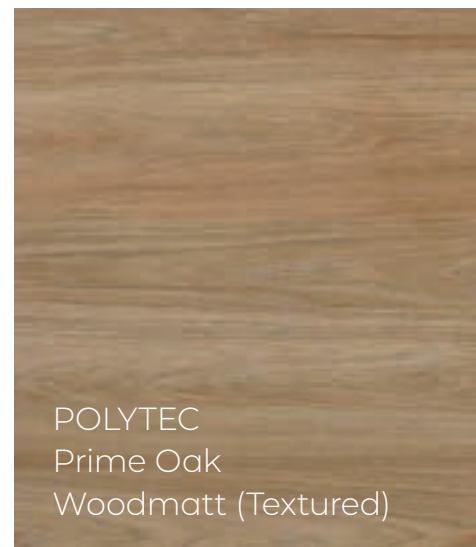

POLYTEC
 Prime Oak
 Woodmatt (Textured)



LAMINEX
Sublime Teak
Chalk (Textured)



LAMINEX
Elegant Oak
Chalk (Textured)



LAMINEX
Rural Oak
Chalk (Textured)

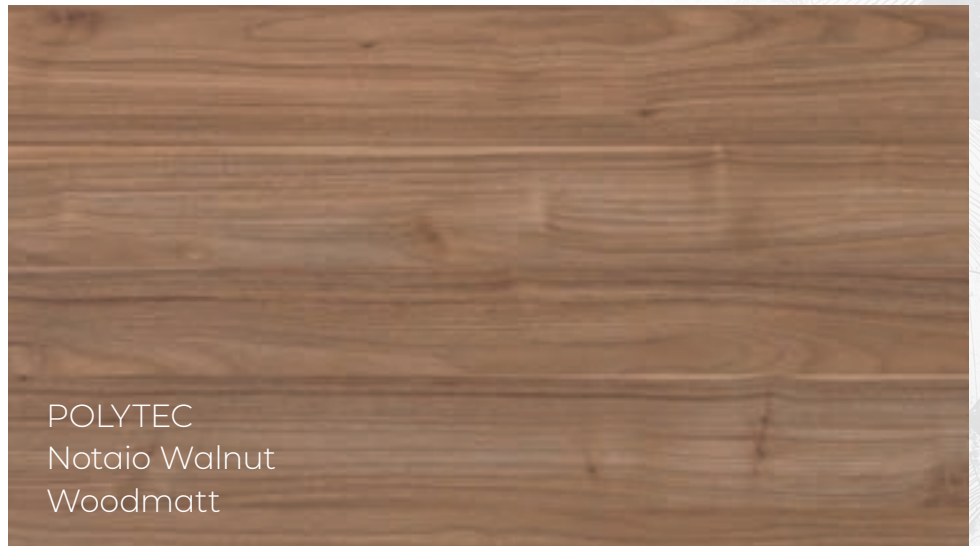

POLYTEC
Notaio Walnut
Woodmatt

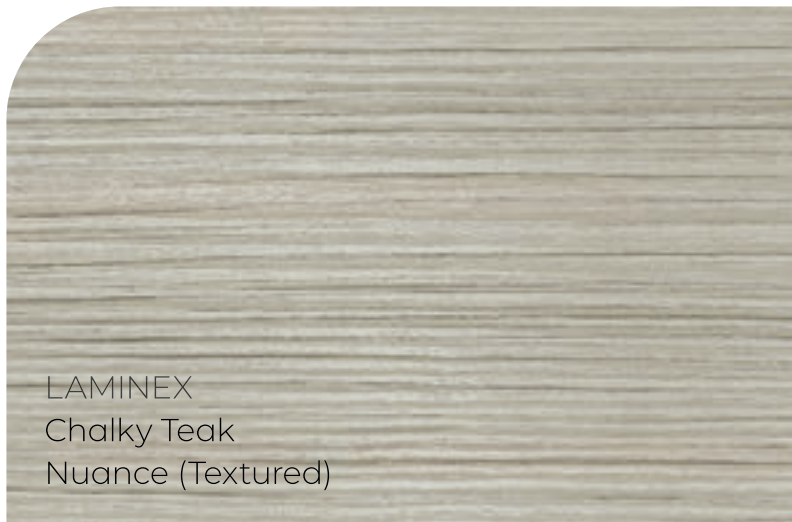

LAMINEX
Chalky Teak
Nuance (Textured)



LAMINEX
Concrete Formwood
Chalk (Textured)



LAMINEX
Delana Oak
Chalk (Textured)



LAMINEX
Fox Teakwood
Chalk (Textured)

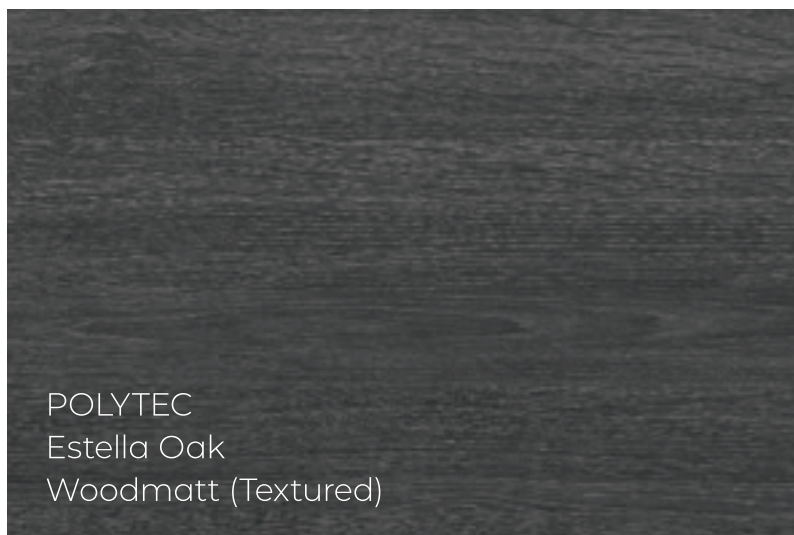

POLYTEC
Estella Oak
Woodmatt (Textured)



LAMINEX
Artisan Beamwood
Chalk (Textured)



POLYTEC
Antico Oak
Woodmatt

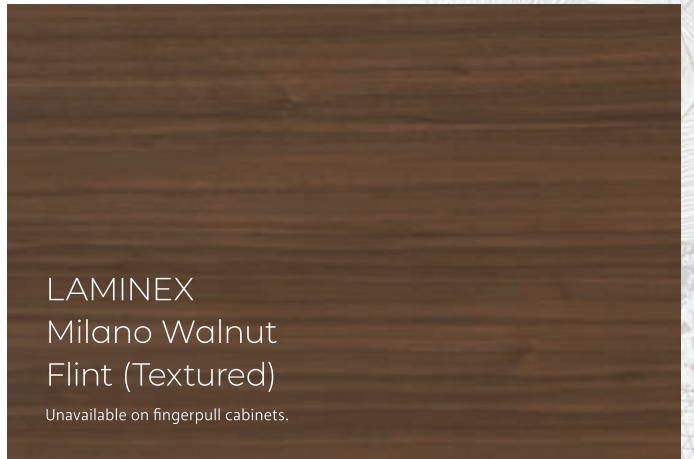

LAMINEX
Milano Walnut
Flint (Textured)
Unavailable on fingerpull cabinets.

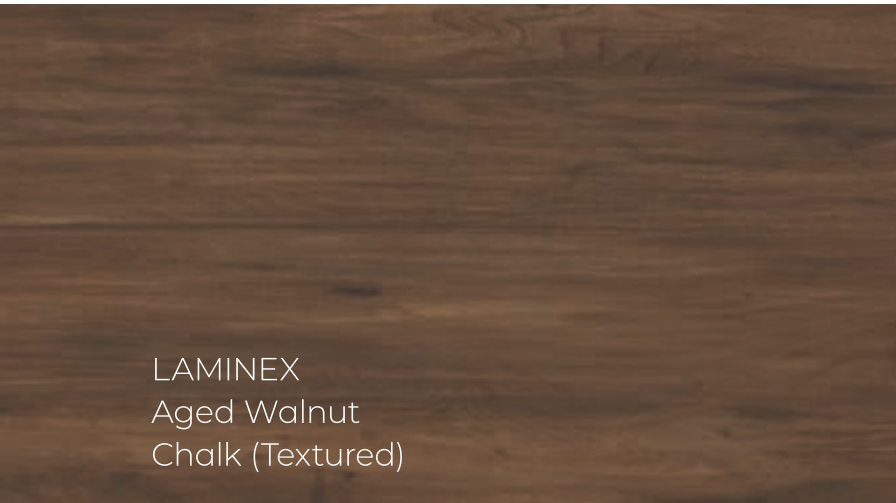

LAMINEX
Aged Walnut
Chalk (Textured)

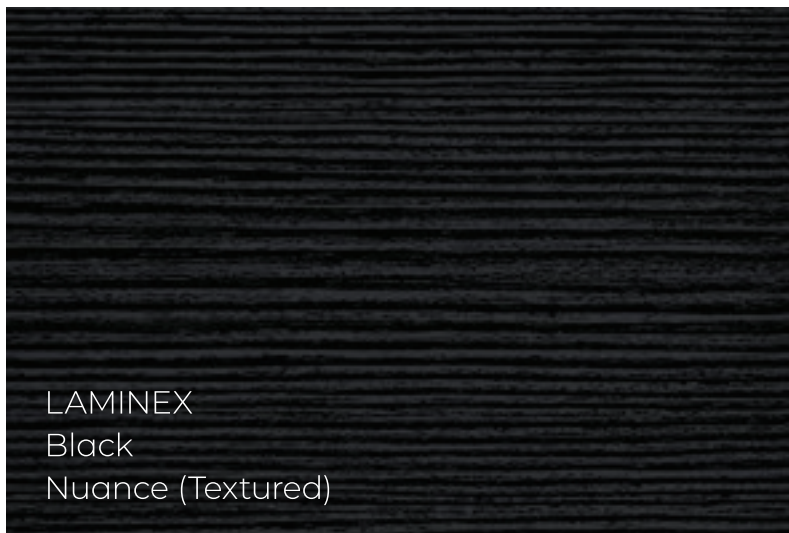

LAMINEX
Black
Nuance (Textured)



POLYTEC
Perugian Walnut
Woodmatt

STANDARD
Thermo-laminated
CABINET FINISHES

Select any of the following standard cabinet finishes at no extra charge. Colour availability depends on model as indicated below. We highly recommend checking physical colour samples prior to placing your order.

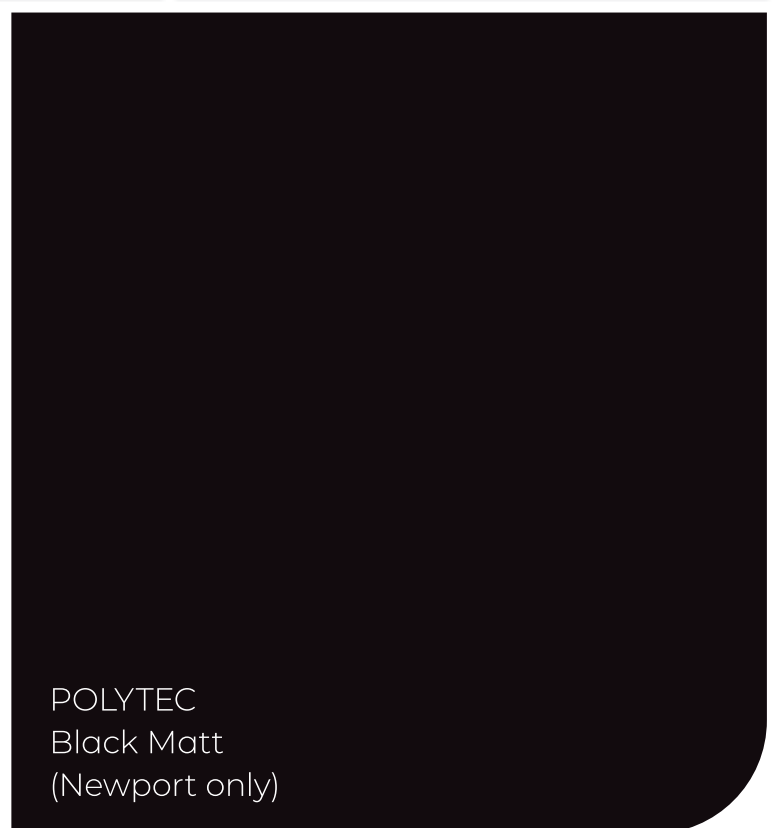
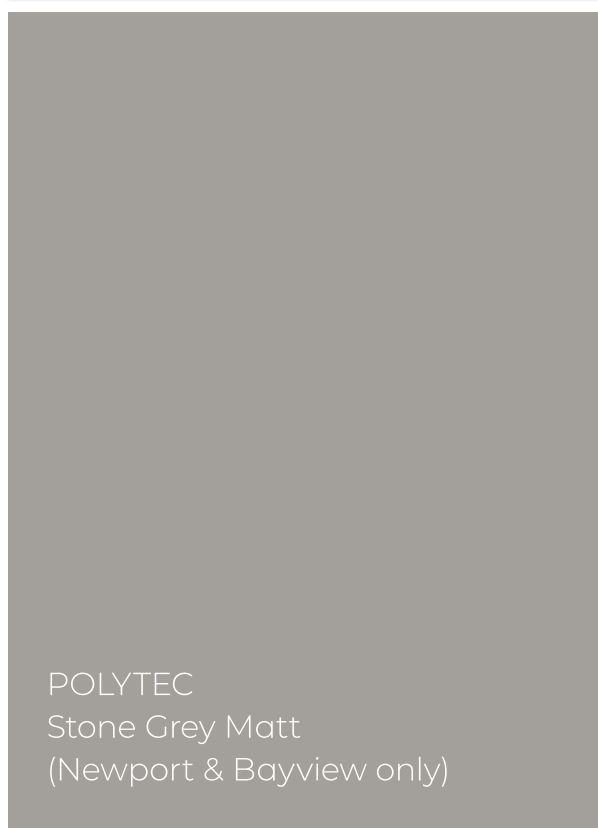
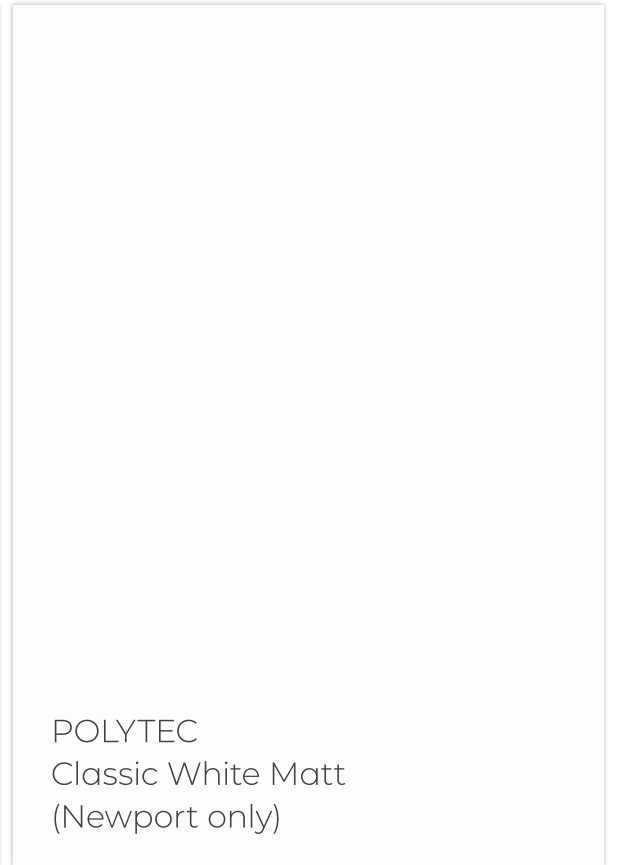

CABINET *Handles*

Handles are included in the prices of the cabinets listed in this brochure.



DALLAS HANDLE

COLOUR	SIZE*	CODE
Chrome	96 mm	HANDLEDS96C
	160 mm	HANDLEDS160C
	288 mm	HANDLEDS288C
	352 mm	HANDLEDS352C
Satin Chrome	96 mm	HANDLEDS96SC
	160 mm	HANDLEDS160SC
	288 mm	HANDLEDS288SC
	352 mm	HANDLEDS352SC
Matte Black	96 mm	HANDLEDS96MB
	160 mm	HANDLEDS160MB
	288 mm	HANDLEDS288MB
	352 mm	HANDLEDS352MB
Brushed Nickel	96 mm	HANDLEDS96BN
	160 mm	HANDLEDS160BN
	288 mm	HANDLEDS288BN
	352 mm	HANDLEDS352BN

*All measurements represent the distance between the centre-hole mounting points.

URBANE HANDLE

COLOUR	SIZE*	CODE
Matte White	128 mm	HANDLEU128MW
	192 mm	HANDLEU192MW
	320 mm	HANDLEU320MW
Matte Black	128 mm	HANDLEU128MB
	192 mm	HANDLEU192MB
	320 mm	HANDLEU320MB
Brushed Nickel	128 mm	HANDLEU128BN
	192 mm	HANDLEU192BN
	320 mm	HANDLEU320BN
Gun Metal	128 mm	HANDLEU128GM
	192 mm	HANDLEU192GM
	320 mm	HANDLEU320GM
Brushed Gold	128 mm	HANDLEU128BG
	192 mm	HANDLEU192BG
	320 mm	HANDLEU320BG

*All measurements represent the distance between the centre-hole mounting points.

KAYA POINT KNOB

COLOUR	SIZE	CODE
Chrome	19.5 mm	HANDLEPCH
Matte Black	19.5 mm	HANDLEPMB
Brushed Nickel	19.5 mm	HANDLEPBN
Urban Brass	19.5 mm	HANDLEPUB
Gun Metal	19.5 mm	HANDLEPGM

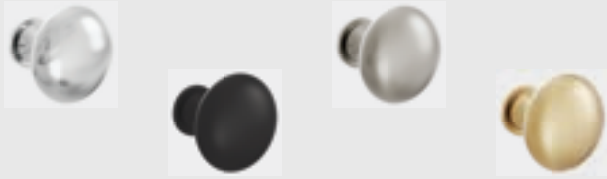

MILA SHAKER KNOB

COLOUR	SIZE	CODE
Chrome	29.8 mm	HANDLEKCH
Matte Black	29.8 mm	HANDLEKMB
Brushed Nickel	29.8 mm	HANDLEKBN
Urban Brass	29.8 mm	HANDLEKUB



RISDON RIGID PULL HANDLE

COLOUR	SIZE*	CODE
Matte Black	96 mm	HANDLER96B

*All measurements represent the distance between the centre-hole mounting points.

HAMPTON PULL HANDLE

COLOUR	SIZE*	CODE
Chrome	64 mm	HANDLEHCH
Matte Black	64 mm	HANDLEHMB
Brushed Nickel	64 mm	HANDLEHBN
Urban Brass	64 mm	HANDLEHUB

*All measurements represent the distance between the centre-hole mounting points.

EDGE ROUND HANDLE

Designed for use with BAYVIEW and KASSI vanity cabinets

COLOUR	SIZE*	CODE
Chrome	40 mm	HANDLEF40C
	200 mm	HANDLEF200C
	350 mm	HANDLEF350C
Matte Black	40 mm	HANDLEF40MB
	200 mm	HANDLEF200MB
	350 mm	HANDLEF350MB
Brushed Nickel	40 mm	HANDLEF40BN
	200 mm	HANDLEF200BN
	350 mm	HANDLEF350BN
Gun Metal	40 mm	HANDLEF40GM
	200 mm	HANDLEF200GM
	350 mm	HANDLEF350GM
Brushed Gold	40 mm	HANDLEF40BG
	200 mm	HANDLEF200BG
	350 mm	HANDLEF350BG

*All measurements represent the distance between the centre-hole mounting points.



STANDARD HANDLE Positions

Handle positions can be customised. See page 71 for custom positions form.



CUSTOMISE YOUR VANITY

Floor Standing

Wall Hung

Kassi

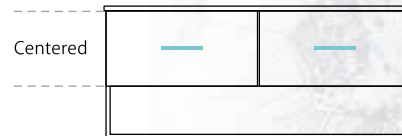
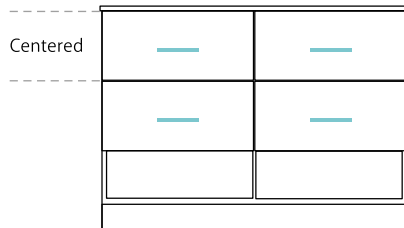

Cierra

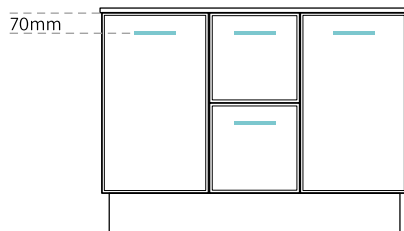

Bayview

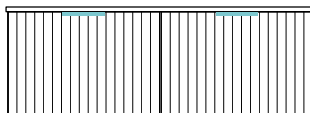

Carmen
Door & Drawer

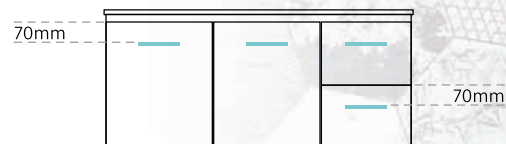
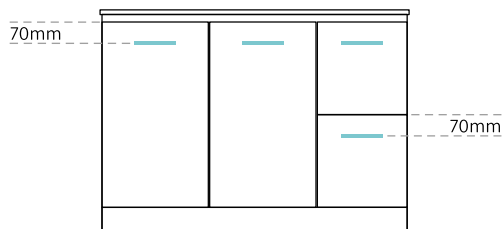

Carmen
All Drawer

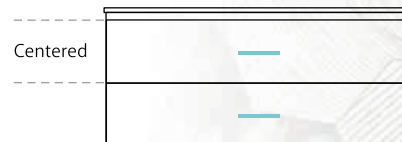
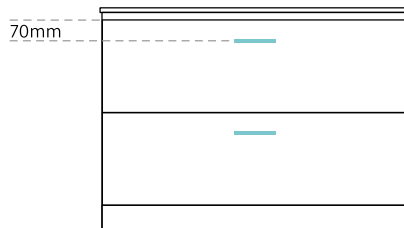

Newport
Door & Drawer

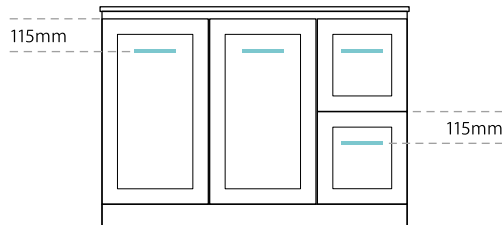

Newport
All Drawer

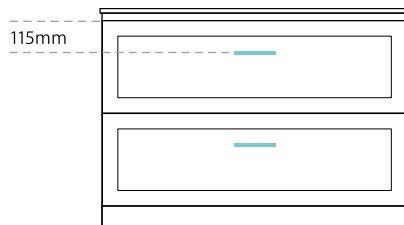

A SIMPLE GUIDE TO *Benchtops & Basins*

To help you select the right top and basin for your vanity, browse the guide below which explains the difference in materials across our moulded basin-tops, benchtops and basin ranges.



Ceramic

- High quality, durable vitreous china
- Easy to clean and highly resistant to discolouration
- Scratch and dent resistant
- 5 years warranty



Engineered Quartz Stone Tops

- Composed of approximately 90% natural quartz
- Easy to clean, durable non-porous surface
- Scratch, dent and heat resistant
- 5 years warranty



Cast Stone Solid Surface

- Velvet-smooth matte finishes (white finish can be repaired like new)
- Easy to clean, durable non-porous surface
- Scratch, dent and heat resistant
- 25 years structural warranty; 5 years finish warranty



Concrete

- Unique warm grey finish with food-grade nano coating
- Variations in patina, surface and colour for a natural look
- Reversible bowl design
- 2 years warranty



Hardwood Timber Tops

- Natural Australian hardwood
- 100% recycled from old Queenslander-style houses
- Variations in colour and grain for a natural look
- 40mm thick with biscuit joints for superior strength
- 1 year warranty



MOULDED Basin-Tops

Moulded basin-tops optimise your benchtop space and feature an easy-to-clean design that is both beautiful and functional. Select from an extensive range of options in different sizes, materials and tap hole configurations.



Dolce

Ceramic, Full Depth

Available with no tap hole, 1 tap hole or 3 tap holes (depending on size).

- SIZES**
- 600 mm
 - 750 mm
 - 900 mm
 - 900 mm Offset (Left or Right Bowl)*
 - 1200 mm (Single Bowl)
 - 1200 mm (Double Bowl)*
 - 1500 mm (Single or Double Bowl)*

*1 tap hole or 3 tap holes only



Vanessa

Poly-Marble, Full Depth

Available with no overflow; 1 tap hole or 3 tap holes.

- SIZES**
- 600 mm
 - 750 mm
 - 900 mm
 - 900 mm
 - 1200 mm (Single Bowl)
 - 1500 mm (Single or Double Bowl)
 - 1800 mm (Single or Double Bowl)



Joli

Ceramic, Full Depth

Available with 1 tap hole or 3 tap holes only.

- SIZES**
- 600 mm
 - 750 mm
 - 900 mm
 - 1200 mm



Rotondo

Ceramic, Full Depth

Available with 1 tap hole or 3 tap holes.

- SIZES**
- 600 mm
 - 750 mm
 - 900 mm
 - 1200 mm



Dolce Matte Black

Ceramic, Full Depth

Available with 1 tap hole or 3 tap holes only.

- SIZES**
- 750 mm
 - 900 mm
 - 1200 mm



Satori

Concrete, Full Depth

Not available with tap holes.

- SIZES**
- 750 mm (Reversible Left or Right Bowl)
 - 900 mm (Reversible Left or Right Bowl)
 - 1200 mm (Reversible Left or Right Bowl)



Delgado

Ceramic, Ensuite Depth

Available with 1 tap hole or 3 tap holes only.

- SIZES**
- 600 mm
 - 750 mm
 - 900 mm
 - 1200 mm



Denzel

Ceramic

Available with 1 tap hole, no overflow and reversible left or right tap position.

- SIZES**
- 450 mm (suits Riley cabinets only)



Ralph

Poly-Marble

Available with 1 tap hole, overflow, no overflow and reversible left or right tap position.

- SIZES**
- 450 mm (suits Riley cabinets only)

Stone & Timber Top

FINISHES

Premium Stone:

Calacatta Marble and Nero Vena engineered quartz stone tops add a premium look to your bathroom design with prominent marble veining.

Hardwood:

Our hardwood tops are made from recycled Australian Spotted Gum or Blackbutt timber with biscuit joints for strength and a durable oil-sealed finish.

Standard Stone:

Carefully crafted for a natural appearance, our 20mm thick engineered quartz stone tops are available in a range of unique colour finishes.

PREMIUM STONE*

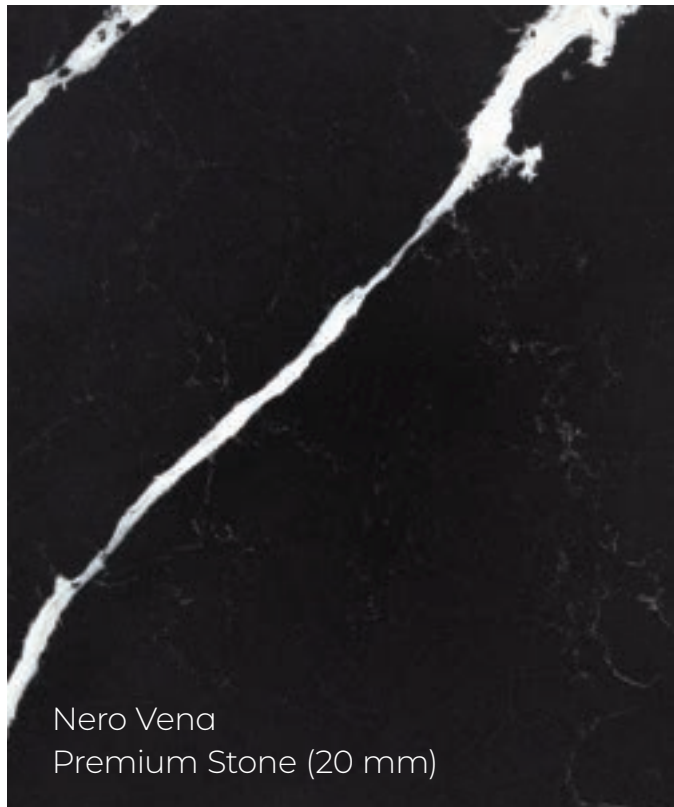

HARDWOOD*

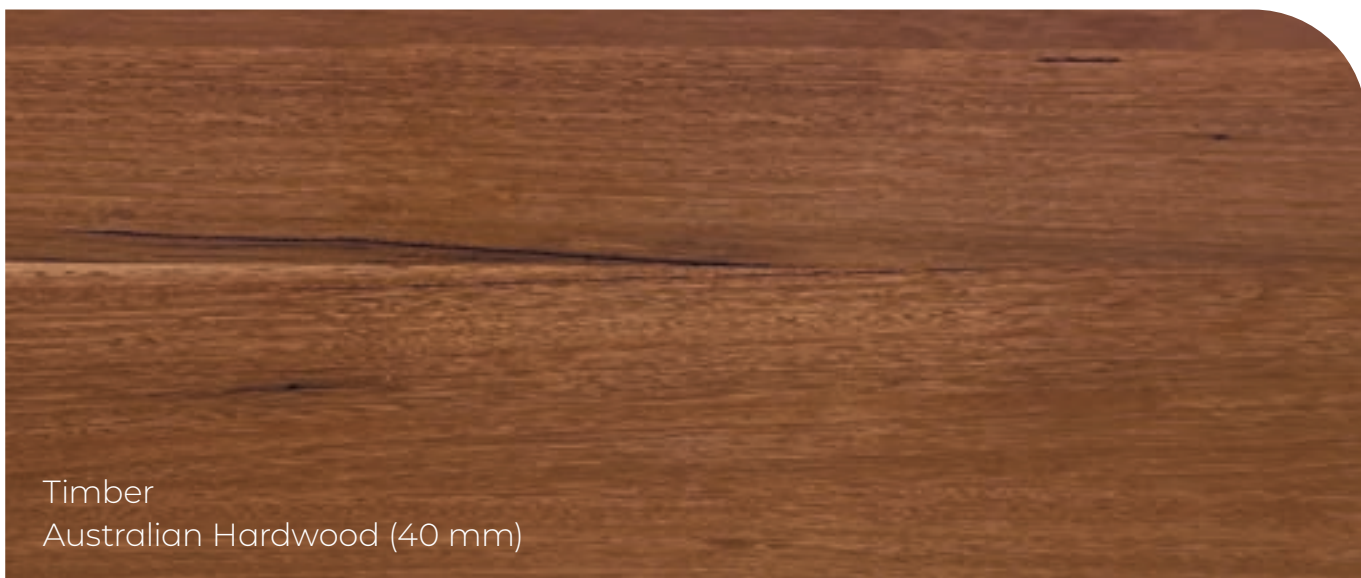

*Variations in colour, direction of marble vein or woodgrain, and prominence of stone fleck or vein may occur, and will be affected by the size of stone or timber top selected.

STANDARD STONE*

CUSTOMISE YOUR VANITY



Crystal Pure Stone (20 mm)

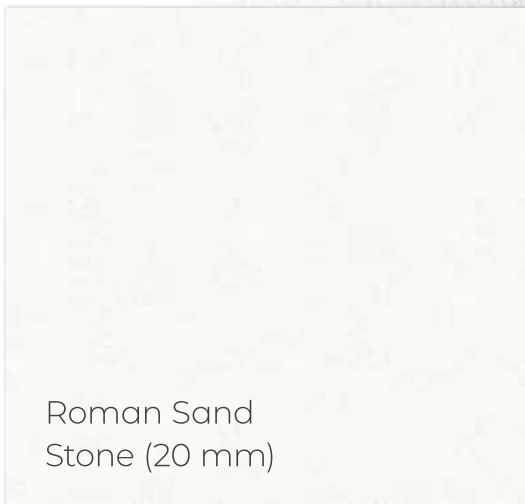

Roman Sand Stone (20 mm)



Terrazo Nougat Stone (20 mm)

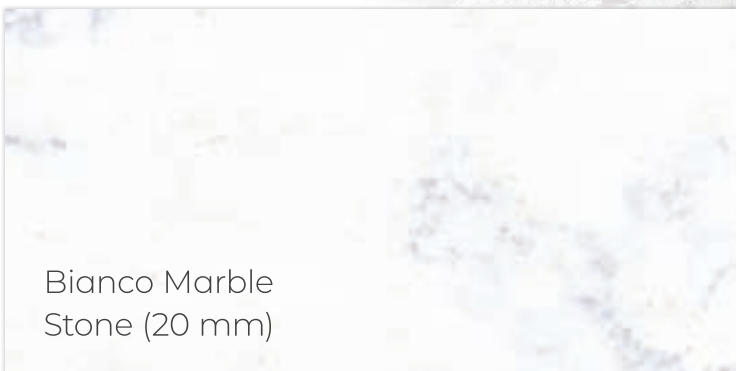

Bianco Marble Stone (20 mm)

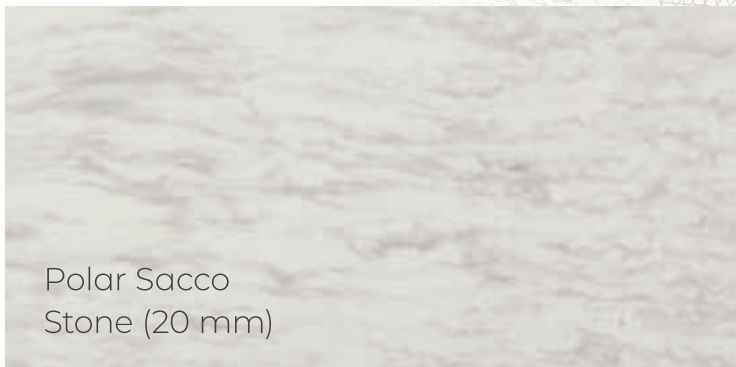

Polar Sacco Stone (20 mm)



Dove Grey Stone (20 mm)

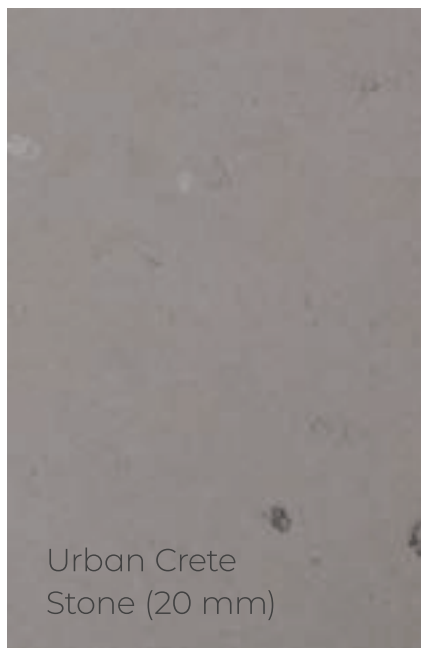

Urban Crete Stone (20 mm)

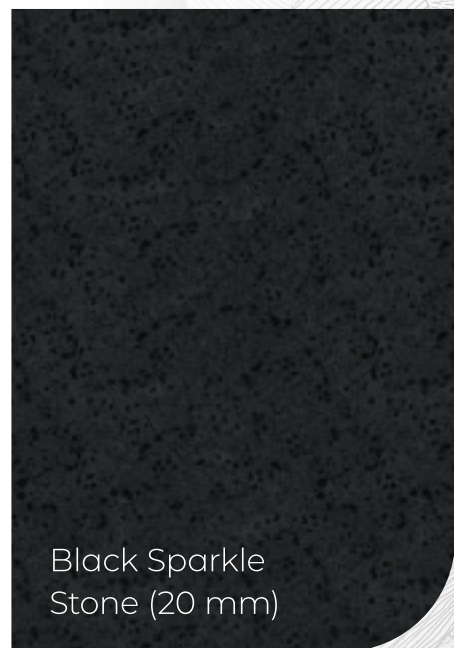

Black Sparkle Stone (20 mm)

*Variations in colour, direction of marble vein or woodgrain, and prominence of stone fleck or vein may occur, and will be affected by the size of stone or timber top selected.



Above Counter

BASINS

Above counter basins sit on top of the counter and provide extra height, helping to keep your counter top clean. They also make a great focal point or centrepiece for your bathroom.

CERAMIC BASINS



ELEANOR Round Gloss White
\$249 • RB465
410 x 410 x 100 mm



ELEANOR Round Matte White
\$420 • RB465MW
410 x 410 x 100 mm



ELEANOR Arch Gloss White
\$249 • RB463
415 x 365 x 100 mm



ELEANOR Arch Matte White
\$420 • RB463MW
415 x 365 x 100 mm



ELEANOR Oval Gloss White
\$249 • RB464
580 x 360 x 100 mm



ELEANOR Oval Matte White
\$420 • RB464MW
580 x 360 x 100 mm



ELEANOR Rectangular Gloss White
\$249 • RB467
500 x 380 x 100 mm



FORMA Gloss White
\$249 • RB480
415 x 365 x 100 mm



REBA MINI Gloss White
\$199 • RB3280
310 x 310 x 110 mm



REBA Gloss White
\$199 • RB3134
360 x 360 x 120 mm



REBA Matte White
\$329 • RB3134W
360 x 360 x 120 mm



REBA Matte Pink Above Counter
\$329 • RB3134P
360 x 360 x 120 mm



REBA Matte Green Above Counter
\$329 • RB3134G
360 x 360 x 120 mm



REBA Matte Blue Above Counter
\$329 • RB3134BLUE
360 x 360 x 120 mm



REBA Matte Light Grey
\$329 • RB3134LG
360 x 360 x 120 mm



REBA Matte Dark Grey
\$329 • RB3134DG
360 x 360 x 120 mm



REBA Matte Black
\$329 • RB3134B
360 x 360 x 120 mm



RAK FEELING Round Gloss White
\$320 • 606000W
420 x 420 x 145 mm



LULU Gloss White
\$199 • TR4037
421 x 421 x 152 mm



ALUCA Gloss White
\$299 • RB821
400 x 400 x 140 mm



ALUCA Matte White
\$399 • RB821W
400 x 400 x 140 mm



ALUCA Matte Black
\$399 • RB821B
400 x 400 x 140 mm



KEETO Gloss White
\$249 • RB814
500 x 350 x 95 mm



PAOLA Gloss White
\$199 • RB3078
410 x 340 x 145 mm



RAK CLOUD Matte White
\$516 • 6000500A
580 x 400 x 150 mm



CHLOE Gloss White
\$199 • RB2245
400 x 400 x 105 mm



KOKO® 370 Gloss White
\$199 • RB184
370 x 370 x 115 mm



KOKO® 465 Gloss White
\$199 • RB185
465 x 375 x 115 mm



KOKO® 465 Matte White
\$480 • RB185MW
465 x 375 x 115 mm



KOKO® 465 Matte Black
\$480 • RB185B
465 x 375 x 115 mm



PETRA Gloss White, No Tap Hole
\$199 • RB196
390 x 390 x 130 mm



EVIE Gloss White
\$199 • TR4322
400 x 400 x 120 mm



LUCIANA® Gloss White
\$249 • RB2178
510 x 405 x 110 mm



LUCIANA® Matte Black
\$430 • RB2178B
510 x 405 x 110 mm

ABOVE COUNTER, CERAMIC BASINS

RAK
CERAMICS



RAK FEELING Rectangular Gloss White
\$320 • 606200W
500 x 360 x 130 mm

RAK
CERAMICS



RAK FEELING Oval Gloss White
\$320 • 606100W
550 x 350 x 130 mm



CHICA 405 Gloss White
1 tap hole \$199 • RB2201
405 x 405 x 120 mm



CHICA 500 Gloss White
1 tap hole \$199 • RB2202
505 x 385 x 120 mm



PETRA MINI Gloss White
1 tap hole \$249 • RB2177
420 x 420 x 120 mm



PETRA Gloss White
1 tap hole \$249 • RB2173
3 tap holes \$299 • RB2173-3
500 x 420 x 120 mm



PETRA Matte Black
1 tap hole \$460 • RB2173B
3 tap holes \$510 • RB2173B-3
500 x 420 x 120 mm



HELEN JUNIOR Gloss White
1 tap hole \$199 • TR4148
3 tap holes \$249 • TR4148-3
380 x 380 x 125 mm



WILLOW Gloss White
1 tap hole \$249 • RB7033
3 tap holes \$299 • RB7033-3
495 x 395 x 150 mm



COMO Gloss White
1 tap hole \$199 • 7078W
475 x 435 x 80 mm



MODENA BABY Gloss White
1 tap hole \$165 • TR4549
330 x 290 x 120 mm



MODENA Gloss White
1 tap hole \$285 • RB07N
590 x 450 x 150 mm





ABOVE COUNTER, CONCRETE BASINS

Embracing natural materials, Jada basins have unique visual appeal with variations in patina, surface and colour. They are designed to blend naturally with your bathroom to create a rich, authentic space.

JADA Warm Grey
\$399 • RB199
390 x 390 x 120 mm

ABOVE COUNTER, CAST STONE BASINS



BAHAMA Matte White
\$399 • CSB01
600 x 350 x 105 mm



CLASSIQUE 600 Matte White
\$449 • CSB03
600 x 345 x 105 mm



CLASSIQUE 420 Matte White
\$399 • CSB02
420 x 420 x 105 mm



BAHAMA Matte Black
\$599 • CSB01-MB
600 x 350 x 105 mm



CLASSIQUE 600 Matte Black
\$649 • CSB03-MB
600 x 345 x 105 mm



CLASSIQUE 420 Matte Black
\$599 • CSB02-MB
420 x 420 x 105 mm



NERO Matte White
\$499 • CSB63
580 x 380 x 145 mm



BAHAMA MKII Matte White
\$499 • CSB61
600 x 357 x 160 mm



ANTONIA Matte White
\$499 • CSB088
600 x 410 x 110 mm



LEXY Matte White
\$399 • CSB038
380 x 380 x 160 mm



RONDO 400 Matte White
1 tap hole \$399 • CSB09
3 tap holes \$449 • CSB09-3
410 x 415 x 105 mm



RONDO 600 Matte White
1 tap hole \$469 • CSB010
3 tap holes \$519 • CSB010-3
600 x 415 x 105



KOKO Ceramic*

For Stone Tops

(Centre basin-hole with no tap hole or 12 o'clock tap hole only)

Gloss White \$249 • RB561

Matte White \$299 • RB561MW

Matte Black \$299 • RB561B

For all other Stone Top Cuts

\$649 • RB561-UM

470 x 350 x 173 mm

Undermount

BASINS

This type of basin is mounted to the stone top from underneath. Undermount basins provide plenty of counter space and make cleaning easy.

SARAH Ceramic Gloss White*

For Stone Tops

(Centre basin-hole with no tap hole or 12 o'clock tap hole only)

\$199 • TR4070

For all other Stone Top cuts

\$599 • TR4070-UM

465 x 345 x 210 mm



*Not available with hardwood tops or 1200 mm double bowl vanities

All prices include the undermount or semi-inset basin hole cut for the vanity top.

Semi-Inset

BASINS

Semi-inset basins are a design hybrid of the above counter and fully-inset basin styles. They are a great option for those wanting an above counter look with more counter space.



PETRA MINI Ceramic Gloss White

1 tap hole \$339 • RB2601-SEMI

433 x 303 x 55 mm



PETRA Ceramic Gloss White

1 tap hole \$389 • RB4063-SEMI

420 x 420 x 50 mm



ALISON Ceramic Gloss White

1 tap hole \$389 • TR4975-SEMI

405 x 405 x 60 mm



PARISA Ceramic

No tap hole \$389 • RB5033-0-SEMI

1 tap hole \$389 • RB5033-1-SEMI

515 x 370 x 65 mm



REBA Ceramic Gloss White

1 tap hole \$360 • RB4066-SEMI

390 x 390 x 50 mm



REBA Ceramic Gloss White

\$339 • RB3134D-SEMI

(10 o'clock or 2 o'clock only)

355 x 355 x 48 mm



KADOS Cast Stone Matte White

For Stone Tops

(Centre basin-hole and one 12 o'clock tap hole only)

\$420 • CSB05

For all other Stone Top cuts and all Hardwood cuts

\$560 • CSB05-SEMI

450 x 330 x 80 mm



SARAH Ceramic Gloss White

For Stone Tops

(Centre basin-hole and one 12 o'clock tap hole only)

\$199 • RB4071

For all other Stone Top cuts and all Hardwood cuts

\$339 • RB4071-SEMI

440 x 310 x 50 mm

BASIN Accents



UNIVERSAL POP-UP/PULL-OUT WASTES (32/40 mm waste)

Our Universal Pop-Up/Pull-Out wastes are convertible for use with or without an overflow. The entire top section of the waste can be pulled out for easy cleaning.



Chrome
\$49 • WAS72



Matte Black
\$80 • WAS72MB



Brushed Nickel
\$80 • WAS72BN



Gun Metal
\$80 • WAS72GM



Urban Brass
\$80 • WAS72UB



Warm Grey Concrete
\$100 • WAS72CC

POP-UP WASTES (32 mm waste)

Dome cap pop-up wastes to suit any colour scheme, available in three cap materials and a range of colours.



Ceramic Cap
Gloss White \$60
No Overflow WAS81
With Overflow WAS82



Ceramic Cap
Matte White \$60
No Overflow WAS59MW
With Overflow WAS58MW



Ceramic Cap
Matte Blue \$60
No Overflow WAS59BLUE
With Overflow WAS58BLUE



Ceramic Cap
Matte Pink \$60
No Overflow WAS59P
With Overflow WAS58P



Ceramic Cap
Matte Green \$60
No Overflow WAS59GR
With Overflow WAS58GR



Ceramic Cap
Matte Light Grey \$60
No Overflow WAS59LG
With Overflow WAS58LG



Ceramic Cap
Matte Dark Grey \$60
No Overflow WAS59DG
With Overflow WAS58DG



Ceramic Cap
Matte Black \$60
No Overflow WAS59MB
With Overflow WAS58MB



Cast Stone Cap
Matte White \$65
No Overflow WAS59W
With Overflow WAS58W



Cast Stone Cap
Matte Black \$65
No Overflow WAS59B
With Overflow WAS58B



Brass Cap
Chrome \$30
No Overflow WAS59
With Overflow WAS58

OVERFLOW RINGS

For All Basins (except Sarah Undermount)

Rectangular White
\$10 • OVERFLOWSQW



Rectangular Black
\$10 • OVERFLOWSQB



JOLI White
\$16 • OVERFLOWJW
For JOLI basin-tops only



Round Chrome
\$10 • OVERFLOWCHR



Round Matte White
\$15 • OVERFLOWMW



Round Matte Black
\$10 • OVERFLOWBLK



Round Brushed Nickel
\$16 • OVERFLOWBN



Round Gun Metal
\$16 • OVERFLOWGM



Round Urban Brass
\$16 • OVERFLOWUB



For Sarah Undermount Basin

Round Chrome
\$12 • OVERFLOWCHR2



Round Matte White
\$15 • OVERFLOWMW2



Round Matte Black
\$12 • OVERFLOWBLK2



Round Brushed Nickel
\$18 • OVERFLOWBN2



Round Gun Metal
\$18 • OVERFLOWGM2



Round Urban Brass
\$18 • OVERFLOWUB2



AUSTRALIAN MADE COLLECTION - ORDER FORM



To make placing an order a little bit easier, complete the form below and email to: sales@fienza.com.au

We strongly suggest that this form be completed by the Retailer. .

Store Details		
COMPANY NAME:	BRANCH NAME (if applicable):	PURCHASE ORDER NUMBER:
Cabinet / Mirror Details		
CABINET / MIRROR CODE:	CABINET / MIRROR NAME:	
COLOUR / FINISH (availability dependent on model):	MOUNTING: <input type="radio"/> Wall <input type="radio"/> Floor	FILL PANEL (Optional; add RRP \$49 per panel): <input type="radio"/> One <input type="radio"/> Two <input type="radio"/> N/A
CABINET DRAWER POSITION: <input type="radio"/> Left <input type="radio"/> Right <input type="radio"/> N/A	ALL DRAWER VANITY CABINET - BOTTOM DRAWER PIPE CUT-OUT: <input type="radio"/> Yes <input type="radio"/> No	
OPENING OPTION: <input type="radio"/> Finger-pull (if applicable; availability dependent on model) <input type="radio"/> Handle Style 1 - Code: _____ <input type="radio"/> Handle Style 2 - Code: _____ <small>Please note: Handles are not required if finger-pull option is selected.</small>	HANDLE QUANTITY: Handle Style 1: <input type="radio"/> One <input type="radio"/> Two <input type="radio"/> Three <input type="radio"/> Four <input type="radio"/> Six Handle Style 2: <input type="radio"/> One <input type="radio"/> Two <input type="radio"/> Three <input type="radio"/> Four <input type="radio"/> Six	HANDLE POSITION (see diagrams of standard positions on page 57): <input type="radio"/> Standard <input type="radio"/> Other (Complete Custom Positions Form)
Vanity Top Details (if applicable; for Stone & Timber Tops only)		
BASIN-TOP (if applicable; availability dependent on cabinet size.): <input type="radio"/> Dolce <input type="radio"/> Dolce Matte Black <input type="radio"/> Joli <input type="radio"/> Rotondo <input type="radio"/> Satori Concrete <input type="radio"/> Vanessa <input type="radio"/> Delgado Ensuite <input type="radio"/> Dolce Offset, Left (900 only) <input type="radio"/> Dolce Offset, Right (900 only) <input type="radio"/> Denzel (Riley cabinet only) <input type="radio"/> Ralph (Riley cabinet only)		
STONE OR TIMBER TOP (availability dependent on cabinet configuration): <input type="radio"/> Bianco Marble <input type="radio"/> Crystal Pure <input type="radio"/> Roman Sand <input type="radio"/> Terrazzo Nougat <input type="radio"/> Polar Sacco <input type="radio"/> Dove Grey <input type="radio"/> Urban Crete <input type="radio"/> Black Sparkle <input type="radio"/> Calacatta Marble <input type="radio"/> Nero Vena <input type="radio"/> Hardwood		
TAP HOLES (availability for basin-tops dependent on model): <input type="radio"/> No Tap Holes <input type="radio"/> 1 Tap Hole <input type="radio"/> 3 Tap Holes (Add RRP \$50 per bowl)		
TAP HOLE POSITION: Single Bowl: <input type="radio"/> 10 o'clock <input type="radio"/> 12 o'clock <input type="radio"/> 2 o'clock <input type="radio"/> Other (Complete Custom Positions Form) Double Bowl: <input type="radio"/> Outsides (LH 10 o'clock, RH 2 o'clock) <input type="radio"/> 12 o'clock <input type="radio"/> Insides (LH 2 o'clock, RH 10 o'clock) <input type="radio"/> Other (Complete Custom Positions Form)		
Basin Details (if applicable; for Stone & Timber Tops only)		
BASIN CODE:	BASIN NAME:	
BASIN QUANTITY: <input type="radio"/> One <input type="radio"/> Two	BASIN POSITION: <input type="radio"/> Centre <input type="radio"/> Other (Complete Custom Positions Form)	
BASIN ACCENTS: <input type="radio"/> Pop-Up Waste - Code: _____ <input type="radio"/> Overflow Ring - Code: _____	BASIN ACCENTS QUANTITY: Pop-Up Waste: <input type="radio"/> One <input type="radio"/> Two Overflow Ring: <input type="radio"/> One <input type="radio"/> Two	
Additional Items (please complete a separate order form for each item selected)		
<input type="radio"/> Framed Mirror <input type="radio"/> Mirror Cabinet <input type="radio"/> Display Shelf Mirror Cabinet <input type="radio"/> Wall Cabinet <input type="radio"/> Combination Cabinet <input type="radio"/> Tallboy		
Retailer Approval		
Please check your selections carefully as Fienza cannot be held responsible for incorrect choices. Once the order has been manufactured it cannot be altered or cancelled.		
TOTAL CABINET RRP:	TOTAL BASIN RRP (if applicable):	TOTAL RRP:
COMPLETED BY:	SIGNATURE	DATE:

AUSTRALIAN MADE COLLECTION - CUSTOM POSITIONS FORM

This form must be completed by the Retailer and submitted with a completed Australian Made Cabinets order form.

Please note: Custom waste and tap hole cuts may incur additional charges. Email your completed form to: sales@fienza.com.au

Store Details		
COMPANY NAME:	BRANCH NAME (if applicable):	PURCHASE ORDER NUMBER:
Vanity Details		
STONE COLOUR / HARDWOOD:	TAP HOLE: <input type="radio"/> Yes <input type="radio"/> No	WASTE HOLE DIAMETER: <input type="radio"/> 64 mm <input type="radio"/> 88 mm

Vanity Top Diagram **IMPORTANT: Please mark waste hole and tap hole positions, along with the required measurements below:**

- Waste Hole Measurements: 1. Mark the distance from the centre of the vanity top to the centre of the waste hole.
 2. Mark the distance from the centre of the waste hole to the back edge of the vanity top.
- Tap Hole Measurements: 3. Mark the distance from the centre of the tap hole to: (a) the side edge of the vanity top; and (b) the back edge of the vanity top.

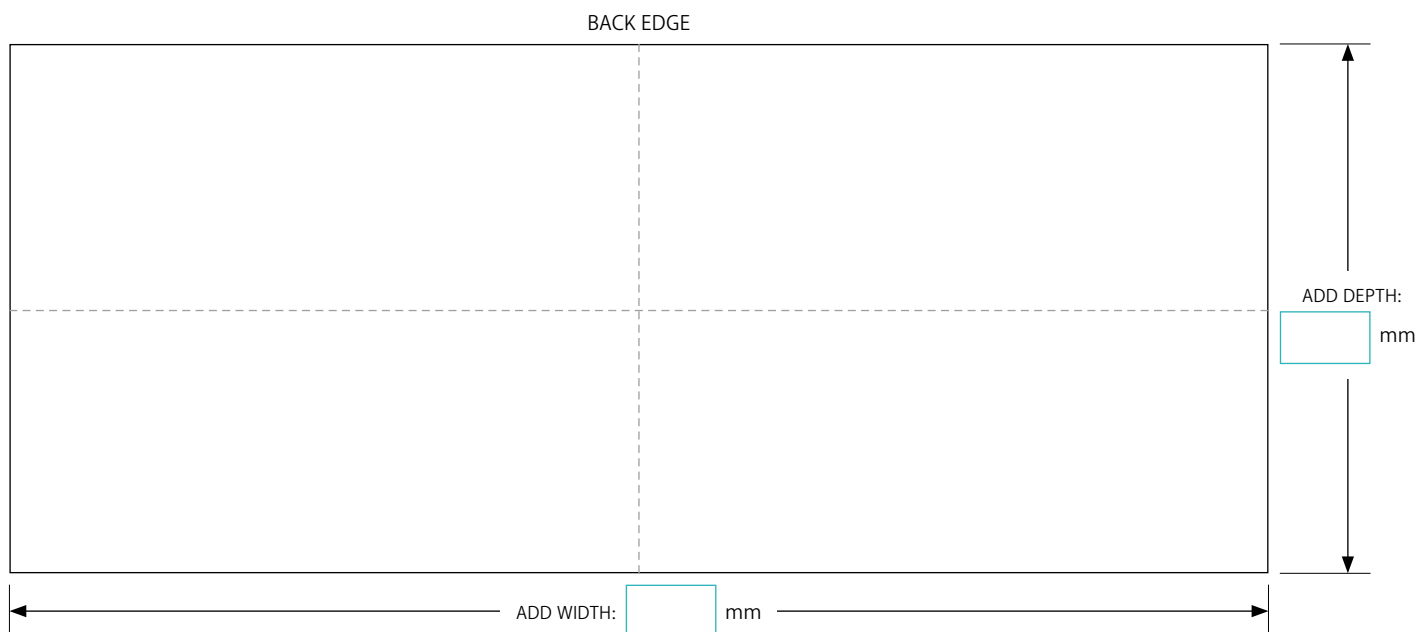

Handle Diagram

Please mark custom handle positions using these cabinet door and drawer diagrams.

Please note: For off-centre door positions, left and right will be assigned according to door opening.

Refer to page 57 for standard positions.

Handle Style 1

Doors

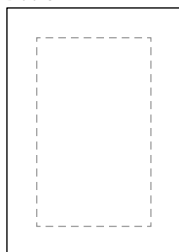

Drawers

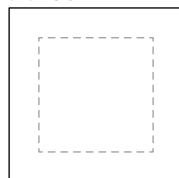

Handle Style 2

Doors

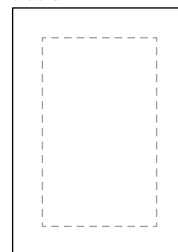

Drawers

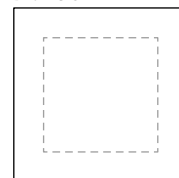

Retailer Approval		
Once signed, these cutting specifications are final. Any changes after the order has been processed will require a new order to be submitted. Fienza may not be able to rectify any errors made on this form after the stone/timber has been cut. By signing this form you confirm the accuracy of the information provided.		
COMPLETED BY:	SIGNATURE	DATE:



fienza®

Beautiful, quality
Bathware

At Fienza our core passion is to excite you with new, innovative and cutting-edge designer products.

Our commitment to international quality standards has ensured that Fienza continues to be the preferred choice for beautiful bathrooms and kitchens all over Australia.

Fienza® products are available through all leading bathroom, kitchen and plumbing retailers.

For more information, contact us or visit our website:

P (07) 3490 6700

E info@fienza.com.au

www.fienza.com.au

Retailer/Distributor: