

# *Lighting Inspirations*

*DESIGNER COLLECTION*

*- Circa 1965 -*

## *Catalogue 2023/24*

*“Be Inspired  
And  
Discover  
The Difference”*



*Phone - 03 - 9486 4115*

*Email - [lodelighting@bigpond.com](mailto:lodelighting@bigpond.com) Website - [www.lightinginspirations.com.au](http://www.lightinginspirations.com.au)*

*Showroom/Office - 301/317 Rae Street Fitzroy North Vic 3068 - P.O Box- 1198 Fitzroy North Victoria 3068 Australia*

## - Quick Reference Index -

P - 1	NOVA	P- 51/52	ZURICH GOLD	P - 102	VICTORIANA & CAMBRIDGE
P - 2	CHESTER - ROCKFORD	P - 53	CHOPPIN - MOZART		RANGE BRASS
	SUMMIT	P - 54	HARBOUR - REGATTA	P - 103	ST KILDA RANGE BRASS
P - 3	MONROE		NAVIGATOR - ADMIRAL	P - 104	SENATOR RANGE BRASS
P - 4	GATSBY		MARINA - MARITIME	P - 105	EMPIRE RANGE BRASS
P - 5	CARTER- SPACEY	P- 55/56	JUNCTION	P - 106	PREMIER RANGE BRASS
P - 6	JEFFERSON	P- 57/58	KINGDOM	P - 107	R/S & B/F SCHOOLHOUSE BRASS
P - 7	KEYS - BANKERS T/L	P - 59	CROWN	P - 108	R/S & B/F DECO RANGE BRASS
P - 8	RIDGE - MAIN - CAPE	P - 60	CROWN - MONARCH	P - 109	R/S & B/F DECO RANGE BRASS
P - 9	COUNTRY	P- 61/62	ALBANY	P - 110	R/S & B/F SPHERES BRASS
P - 10	MONTANA SATIN BRASS	P- 63/64	FLINDERS BRONZE	P - 111	EDWARDIAN RANGE BRASS
P - 11	MONTANA CHROME	P- 65/66	FLINDERS BLACK	P - 112	WAREHOUSE RANGE BRASS
P - 12	MONTANA BRONZE	P- 67/68	WATERFORD	P - 113	ACCESSORIES CHROME
P - 13	MICHIGAN CHROME	P- 69/70	WELLINGTON	P - 114	WALL LIGHTS RANGE CHROME
P - 14	MICHIGAN BRONZE	P- 71/72	STRAND	P - 115	ST KILDA RANGE CHROME
P - 15	MANOR CHROME	P- 73/74	TILBURN	P - 116	SENATOR RANGE CHROME
P - 16	MANOR BRONZE	P- 75/76	MAYFAIR	P - 117	EMPIRE RANGE CHROME
P - 17	DALTON RANGE	P - 77	ARGYLE	P - 118	PREMIER RANGE CHROME
P - 18	ASPEN RANGE	P - 78	STATION	P - 119	R/S & B/F SCHOOLHOUSE CHROME
P - 19	DALLAS BRONZE	P - 79	URBAN	P - 120	R/S & B/F DECO RANGE CHROME
P - 20	DALLAS BRONZE	P - 80	TERMINAL	P - 121	R/S & B/F DECO RANGE CHROME
P - 21	DALLAS CHROME	P - 81	PORT	P - 122	R/S & B/F SPHERES CHROME
P - 22	DALLAS CHROME	P - 82	DOCKYARD	P - 123	PARAMOUNT RANGE CHROME
P - 23	HOUSTON BRONZE	P - 83	DECKHOUSE	P - 124	PARAMOUNT RANGE CHROME
P - 24	HOUSTON BRONZE	P - 84	GATEWAY - PIER - WHARF	P - 125	ACCESSORIES PATINA
P - 25	HOUSTON CHROME	P - 85	PARKWAY	P - 126	WALL LIGHTS RANGE PATINA
P - 26	HOUSTON CHROME	P - 86	CAUSEWAY	P - 127	ST KILDA RANGE PATINA
P - 27	BENSON BRONZE	P - 87	RIVERSIDE BRONZE/BLACK	P - 128	SENATOR RANGE PATINA
P - 28	BENSON CHROME	P - 88	SOUTHBY	P - 129	EMPIRE RANGE PATINA
P- 29/30	LAKESWOOD	P - 89	LAGUNA - MALIBU	P - 130	PREMIER RANGE PATINA
P- 31/32	SALZBURG	P - 90	FAIRLIGHT	P - 131	R/S & B/F SPHERES PATINA
P- 33/34	LOUIS 15th	P - 91	TRANSIT	P - 132	R/S & B/F SCHOOLHOUSE PATINA
P - 35	ODEON	P - 92	PROMENADE	P - 133	R/S & B/F DECO RANGE PATINA
P - 36	CASCADE	P - 93	BOULEVARD	P - 134	R/S & B/F DECO RANGE PATINA
P- 37/38	MARSEILLES	P - 94	PLAZA - PORTICO	P - 135	PARAMOUNT RANGE PATINA
P- 39/40	CELESTIAL CHROME	P - 95	FRONTAGE	P - 136	PARAMOUNT RANGE PATINA
P- 41/42	CELESTIAL BLACK	P - 96	MONTROSE - LOFT	P - 137	GLASSWARE
P- 43/44	ROTONDO	P - 97	WICKHAM	P - 138	GLASSWARE
P - 45	EMPORIA	P - 98	EXTERIOR ACCESSORIES	P - 139	GLASSWARE
P - 46	WATERFALL	P - 99	ACCESSORIES BRASS	P - 140	METAL SHADES
P- 47/48	CLASSIQUE	P - 100	WALL LIGHTS RANGE BRASS		
P- 49/50	ZURICH CHROME	P - 101	LUKE RANGE BRASS		

**NOTE: FOR EXTERIOR FITTINGS ONLY**

# IP Rating Chart

IP ratings are represented by combining the first and second digits of the following columns. See example below.

1st Digit - SOLID Degree of protection against solid objects	2nd Digit - LIQUID Degree of protection against water
No Protection <b>0</b>	No Protection <b>0</b>
<b>1</b>	<b>1</b>
<b>2</b>	<b>2</b>
<b>3</b>	<b>3</b>
<b>4</b>	<b>4</b>
<b>5</b>	<b>5</b>
<b>6</b>	<b>6</b>
<b>Example:</b> <b>IP 65</b>	<b>7</b>
	<b>8</b>

## Difference Between Crystal and Glass

**Key difference:** Glass is a generic name, while, crystal is a subcategory of glass, made in the same manner as glass but with different materials.

Hence, all crystal is glass, but not all glass is crystal.

Scientifically, crystals are pure substances whose atoms, molecules, or ions are arranged in an ordered pattern, where they extend in all three spatial dimensions. Crystals most commonly occur naturally on the earth, though the process of crystal formation via mechanisms of crystal growth is called crystallization or solidification.

While, referring in the same context as glass, crystal refers to well glass. The term crystal is often used to refer to glassware that has a more elegant form than the normal or everyday glassware. However, that is not the official difference between the two. Actually, there is no official clean cut definition of crystal.

Still, the general rule that applies is that crystal is a type of glass that contains lead.

There are three primary criteria for crystal as established by the European Union in 1969: a lead content in excess of 24%, a density in excess of 2.90 and a reflective index of 1.545. However, outside of the European Union, this definition is usually disregarded. In the United States, any glass with more than 1% of lead content is termed as crystal.

Technically, the application of the term 'crystal' to glass is in itself inaccurate, as glass is an amorphous solid. Hence, by definition it lacks a crystalline structure, which is necessary for a crystal. Still, the term, even though erroneously applied to glass, has stuck around and remains popular.

The color and brilliance of glass often varies, depending on its content. Glass made with iron tends to have a green tinge, while glass made with soda-lime will have an aqua tinge. While, some find these tinges to be unattractive, glasses with a greenish hue tend to be considerably stronger. Crystals generally are light in color and are mostly translucent. Some clear crystals have the properties of reflecting light into different colors.

When held in the right position, the refraction and dispersion of light from crystal will create a rainbow of hues.

So, in summation, glass is a generic name, while, crystal is a subcategory of glass, made in the same manner as glass but with different materials. Hence, all crystal is glass, but not all glass is crystal.

### Type of globes required for all our light fittings E14 - E27 - B15 - B22 indicated on all light fittings LED compatible

LED WATTS	INCANDESCENT WATTS (equivalent)	Not available in Australia	LIGHT OUTPUT LUMENS	LIGHTING INSPIRATIONS PRODUCT ADEQUATE LIGHT LEVELS
4-5	-	25-40	-	450 Approx - To suit all multi arm globe fittings.
6-8	-	60	-	750 - 900 Approx - To suit 1/LT wall brackets, 2/LT, 3LT multi arm, 1/LT lanterns and exteriors.
9-13	-	75-100	-	1100-1300 Approx - To suit 1/LT lanterns & pendants, rod sets and exteriors.

**NOTE - Please advise your customers that the longevity of the globe is related to the quality of them. Please purchase high quality globes. Lighting Inspirations (Lode Int) is not liable for damage/altering the integrity of the light fitting due to faulty low quality globes.**

**- Wall Bracket & Vanity Range -**

***Nova  
Range***



**1001372**

**NOVA 1/LT W/B  
BRONZE E27**

**FRAME SIZE -**  
H - 23cm W - 15cm P - 21cm

**1001371**

**NOVA 3/LT SEMI FLUSH BRONZE E27**  
**FRAME SIZE -** H - 34cm W - 41cm



**1001373**

**NOVA  
2/LT W/B  
BRONZE  
E27**

**FRAME SIZE**  
H - 23cm  
W - 42cm  
P - 22cm



***Nova - 1/LT W/B & 2/LT W/B  
Can Be Installed Either  
Facing Up Or Facing Down***



**1001375**

**NOVA 1/LT W/B  
CHROME E27**

**FRAME SIZE -**  
H - 23cm W - 15cm P - 21cm

**1001374**

**NOVA 3/LT SEMI FLUSH CHROME E27**  
**FRAME SIZE -** H - 34cm W - 41cm



**1001376**

**NOVA  
2/LT W/B  
CHROME  
E27**

**FRAME SIZE**  
H - 23cm  
W - 42cm  
P - 22cm



**- Wall Bracket & Vanity Range -**

***Chester,  
Rockford &  
Summit  
Range***



**1001107**

**CHESTER 1/LT W/B CHROME E27**  
FRAME SIZE - H - 25cm W - 12cm P - 11cm

**1001108**

**CHESTER 2/LT W/B CHROME E27**  
FRAME SIZE -  
H - 37cm W - 12cm P - 11cm



**1001106**

**CHESTER 1/LT W/B MATT BLACK E27**  
FRAME SIZE - H - 25cm W - 12cm P - 11cm

**1001109**

**CHESTER 2/LT W/B MATT BLACK E27**  
FRAME SIZE - H - 37cm W - 12cm P - 11cm



**1001428**

**ROCKFORD  
2/LT W/B  
CHROME  
E14**  
FRAME SIZE  
H - 41cm  
W - 12cm  
P - 11cm



**1001481**

**SUMMIT  
2/LT W/B  
CHROME  
E27**  
FRAME SIZE -  
H - 23cm  
W - 40cm  
P - 21cm



**1001480**

**SUMMIT  
1/LT W/B  
CHROME  
E27**  
FRAME SIZE -  
H - 23cm W - 15cm  
P - 19cm

**- Wall Bracket & Vanity Range -**

***Monroe  
Range***



1001255

**MONROE 1/LT W/B BRONZE E27**  
 FRAME SIZE - H - 24cm W - 15cm P - 19cm



1001257

**MONROE 2/LT W/B BRONZE E27**  
 FRAME SIZE - H - 25cm W - 38cm P - 19cm



***Monroe  
1/LT W/B  
&  
2/LT W/B  
Can Be Installed  
Facing Up  
Or  
Facing Down***

1001256

**MONROE 1/LT W/B CHROME E27**  
 FRAME SIZE - H - 25cm W - 15cm P - 19cm



***VANITY  
WALL  
BRACKETS***



1001258

**MONROE 2/LT W/B CHROME E27**  
 FRAME SIZE - H - 25cm W - 38cm P - 19cm



**- Pendant Range -**

***Gatsby  
Bronze  
&  
Chrome  
Range***

***Classic  
Industrial Style  
Glassware  
Pendant***



**1000220**  
**GATSBY  
 PND SMALL  
 CHROME**  
 E27  
 FRAME SIZE -  
 H - 40cm  
 W - 27cm

**- NOTE -**  
 -  
**Supplied**  
**With**  
**1 MT**  
**Chain**  
**&**  
**Canopy**  
 -



**1000221**  
**GATSBY  
 PND SMALL  
 BRONZE**  
 E27  
 FRAME SIZE -  
 H - 40cm  
 W - 27cm



**1000236**  
**GATSBY W/B  
 CHROME**  
 B22  
 FRAME SIZE -  
 H - 20cm W - 14cm  
 P - 13cm



**1000235**  
**GATSBY W/B  
 BRONZE**  
 B22  
 FRAME SIZE -  
 H - 20cm W - 14cm  
 P - 13cm

**1000219**  
**GATSBY  
 PND LARGE  
 BRONZE**  
 E27  
 FRAME SIZE -  
 H - 50cm  
 W - 42cm

**- NOTE -**  
 -  
**Supplied**  
**With**  
**1 MT**  
**Chain**  
**&**  
**Canopy**  
 -



**1000218**  
**GATSBY  
 PND LARGE  
 CHROME**  
 E27  
 FRAME SIZE -  
 H - 50cm  
 W - 42cm



***Globes  
 Not  
 Supplied***

**- Pendant Range -**

**Carter  
&  
Spacey  
Range**

**Classic  
Hampton Style  
Glassware  
Pendant**



1000133

**CARTER  
SMALL  
CHROME  
OPAL**

**E27**

**FRAME SIZE -**

H - 30cm  
W - 28cm



1001248

**SPACEY  
SMALL  
CHROME  
CLEAR**

**E27**

**FRAME SIZE -**

H - 36cm  
W - 25cm

**- NOTE -**

**-**  
**Supplied**  
**With**  
**1 MT**  
**Chain**  
**&**  
**Canopy**  
**-**



1000132

**CARTER  
LARGE  
CHROME  
OPAL**

**E27**

**FRAME SIZE -**

H - 37cm  
W - 35cm



1001247

**SPACEY  
LARGE  
CHROME  
CLEAR**

**E27**

**FRAME SIZE -**

H - 42cm  
W - 35cm



**- NOTE -**

**-**  
**Supplied**  
**With**  
**1 MT**  
**Chain**



**- Pendant Range -**

***Jefferson  
Range***

*In Built  
Angle Canopy*

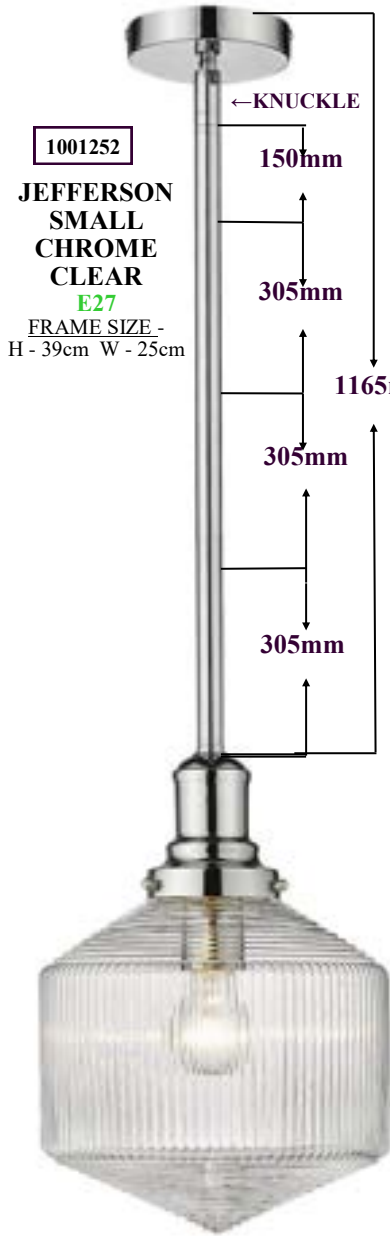

**1001252**  
**JEFFERSON  
 SMALL  
 CHROME  
 CLEAR**  
 E27  
 FRAME SIZE -  
 H - 39cm W - 25cm

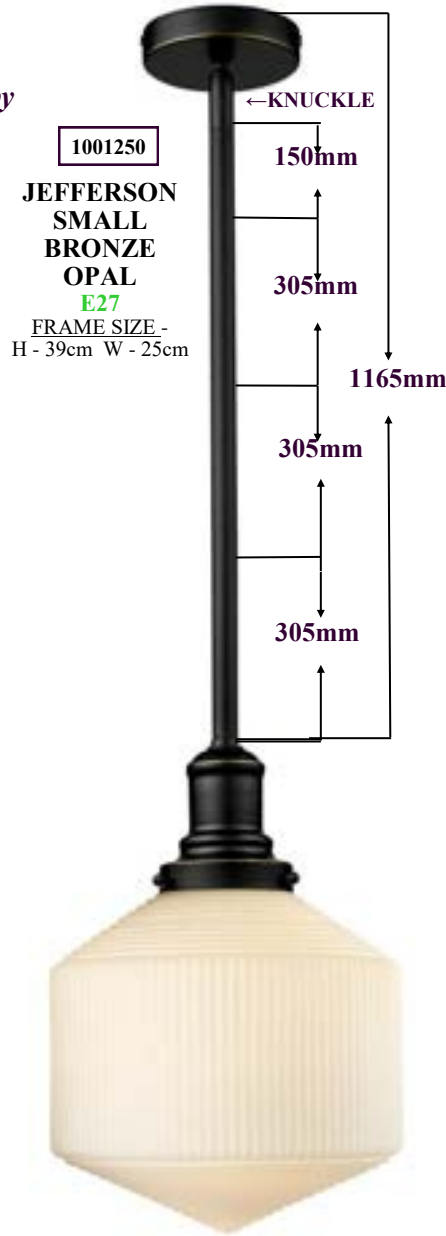

**1001250**  
**JEFFERSON  
 SMALL  
 BRONZE  
 OPAL**  
 E27  
 FRAME SIZE -  
 H - 39cm W - 25cm

***Classic  
 Industrial  
 Style  
 Glassware***



**1001251**  
**JEFFERSON  
 LARGE  
 CHROME  
 OPAL**  
 E27  
 FRAME SIZE -  
 H - 49cm  
 W - 35cm  
**RODS  
 AS  
 PER  
 SMALL**



**1001249**  
**JEFFERSON  
 LARGE  
 BRONZE  
 OPAL**  
 E27  
 FRAME SIZE -  
 H - 49cm  
 W - 35cm  
**RODS  
 AS  
 PER  
 SMALL**

**- Pendant & Table Lamp Range -**

**Keys  
&  
Bankers  
Range**

1001246

**KEYS  
SMALL  
CHROME  
CLEAR**

**E27**

FRAME SIZE -

H - 41cm  
W - 30cm



**Classic  
Hampton Style  
Glassware  
Pendant**

*Globes  
Not  
Supplied*

1001245

**KEYS  
LARGE  
CHROME  
CLEAR**

**E27**

FRAME SIZE -

H - 50cm  
W - 40cm



**- NOTE -**  
**-**  
**Supplied**  
**With**  
**1 MT**  
**Chain**



100082

**BANKERS  
TABLE LAMP  
BRONZE GREEN**

**E14**

FRAME SIZE -

H - 330mm  
W - 270mm  
D - 200mm



**- Pendant Range -**

***Ridge,  
Cape & Main  
Range***

***New***



**1001080**  
**CAPE 1/LT**  
**SATIN BRASS**  
**CLEAR**  
**E27**  
**FRAME SIZE -**  
H - 46cm  
W - 30cm

**- NOTE -**  
**-**  
**Supplied**  
**With**  
**2 MT**  
**Flex**  
**&**  
**Canopy**  
**-**



**1001470**  
**RIDGE 1/LT**  
**SATIN BRASS**  
**CLEAR**  
**E27**  
**FRAME SIZE -**  
H - 45cm  
W - 22cm

**- NOTE -**  
**-**  
**Supplied**  
**With**  
**2 MT**  
**Flex**  
**&**  
**Canopy**  
**-**



**1001320**  
**MAIN 1/LT**  
**SATIN BRASS**  
**CLEAR**  
**E27**  
**FRAME SIZE -**  
H - 51cm  
W - 26cm

**- NOTE -**  
**-**  
**Supplied**  
**With**  
**2 MT**  
**Flex**  
**&**  
**Canopy**  
**-**

***Classic  
Hampton Style  
Glassware  
Pendant***

***Globes  
Not  
Supplied***

- Lantern Range -

*Country  
Bronze  
Range*

*\*Features\*  
Clear  
Beveled  
Glassware*

1000121

COUNTRY  
LANTERN  
LARGE  
4/LT  
BRONZE  
E14  
FRAME SIZE  
H - 80cm  
W - 47cm



1000123

COUNTRY  
LANTERN  
SMALL  
1/LT  
BRONZE  
E27  
FRAME SIZE  
H - 55cm  
W - 30cm



1000122

COUNTRY  
LANTERN  
MEDIUM  
3/LT  
BRONZE  
E14  
FRAME SIZE  
H - 62cm  
W - 37cm



- NOTE -

-  
Supplied  
With  
1 MT  
Chain  
&  
Canopy  
-

**- Lantern Range -**

**Montana  
Satin  
Brass  
Range**

*Globes  
Not  
Supplied*

*New*

**1000651**

**MONTANA  
LANTERN  
SMALL  
3/LT  
SATIN BRASS**

**E14**

**FRAME SIZE  
H - 59cm W - 27cm**

***\*Features\*  
Classic  
Hampton  
&  
Provincial  
Style***

***- NOTE -  
-  
Supplied  
With  
1MT  
Chain  
&  
Canopy  
-***

**1000650**

**MONTANA  
LANTERN  
MEDIUM  
4/LT  
SATIN BRASS**

**E14**

**FRAME SIZE  
H - 72cm W - 38cm**



***Lanterns  
Feature  
Clear  
Beveled  
Glassware***

- Lantern Range -

**Montana  
Chrome  
Range**

1000333

MONTANA  
LANTERN  
MEDIUM  
4/LT  
CHROME  
E14  
FRAME SIZE  
H - 72cm W - 38cm

- NOTE -  
-  
Supplied  
With  
1 MT  
Chain  
&  
Canopy  
-

Globes  
Not  
Supplied

**\*Features\***  
**Classic  
Hampton  
&  
Provincial  
Style**

1000335

MONTANA  
LANTERN  
SMALL  
3/LT  
CHROME  
E14  
FRAME SIZE  
H - 59cm W - 27cm



**Lanterns  
Feature  
Clear  
Beveled  
Glassware**

- Lantern Range -

*Montana  
Bronze  
Range*

*Globes  
Not  
Supplied*

1000336

MONTANA  
LANTERN  
SMALL  
3/LT  
BRONZE  
E14  
FRAME SIZE  
H - 59cm W - 27cm

*\*Features\*  
Classic  
Hampton  
&  
Provincial  
Style*

*- NOTE -  
-  
Supplied  
With  
1MT  
Chain  
&  
Canopy  
-*

1000334

MONTANA  
LANTERN  
MEDIUM  
4/LT  
BRONZE  
E14  
FRAME SIZE  
H - 72cm W - 38cm



*Lanterns  
Feature  
Clear  
Beveled  
Glassware*

- Lantern Range -

**Michigan  
Chrome  
Range**

1000327

MICHIGAN  
LANTERN  
MEDIUM  
3/LT  
CHROME  
E14  
FRAME SIZE  
H - 60cm W - 28cm

- NOTE -

Supplied  
With  
1 MT  
Chain  
&  
Canopy

Globes  
Not  
Supplied

1000329

MICHIGAN  
LANTERN  
SMALL  
1/LT  
CHROME  
E27  
FRAME SIZE  
H - 49cm W - 20cm

*\*Features\**  
*Classic*  
*Hampton*  
*&*  
*Provincial*  
*Style*



*Lanterns  
Feature  
Clear Beveled  
Glassware*



- Lantern Range -

*Michigan  
Bronze  
Range*

*Globes  
Not  
Supplied*

1000330

**MICHIGAN  
LANTERN  
SMALL  
1/LT  
BRONZE**

**E27**

**FRAME SIZE**  
H - 49cm W - 20cm

**- NOTE -**

**-  
Supplied  
With  
1 MT  
Chain  
&  
Canopy  
-**

1000328

**MICHIGAN  
LANTERN  
MEDIUM  
3/LT  
BRONZE**

**E14**

**FRAME SIZE**  
H - 60cm W - 28cm

*\*Features\*  
Classic  
Hampton  
&  
Provincial  
Style*



*Lanterns  
Feature  
Clear Beveled  
Glassware*



**- Lantern Range -**

**Manor  
Chrome  
Range**

***\*Features\*  
Classic  
Hampton  
&  
Provincial  
Style***

**1000411**

**MANOR  
LARGE  
4/LT PND  
CHROME  
E14  
FRAME SIZE -  
H-57cm W-30cm**

***- NOTE -***

***Supplied  
With  
1 MT  
Chain  
&  
Canopy***



***- NOTE -***

***Supplied  
With  
1 MT  
Chain  
&  
Canopy***

**1000410**

**MANOR  
MEDIUM  
3/LT PND  
CHROME  
E14  
FRAME SIZE -  
H-48cm W-25cm**



***Curved  
Panel  
Glassware***

***Globes  
Not  
Supplied***

- Lantern Range -

*Manor  
Bronze  
Range*

*\*Features\*  
Classic  
Hampton  
&  
Provincial  
Style*

1000583

MANOR  
MEDIUM  
3/LT PND  
BRONZE  
E14  
FRAME SIZE -  
H-48cm W-25cm

- NOTE -  
-  
Supplied  
With  
1 MT  
Chain  
&  
Canopy  
-



*Globes  
Not  
Supplied*

*Curved  
Panel  
Glassware*

- NOTE -  
-  
Supplied  
With  
1 MT  
Chain  
&  
Canopy  
-

1000585

MANOR  
LARGE  
4/LT PND  
BRONZE  
E14  
FRAME SIZE -  
H-57cm W-30cm



**- Pendant Range -**

**Dalton  
Range**

**\*Features\***  
Cognac  
Shape  
Clear  
Glassware

Globes  
Not  
Supplied

**1001144**  
**DALTON**  
**3/LT PND**  
**MATT BLACK**  
E27  
FRAME SIZE  
H - 30cm W - 42cm  
RODS & KNUCKLE  
AS PER  
5/LT PENDANT

**1001145**  
**DALTON**  
**5/LT PND**  
**MATT BLACK**  
E27  
FRAME SIZE  
H - 41cm W - 60cm

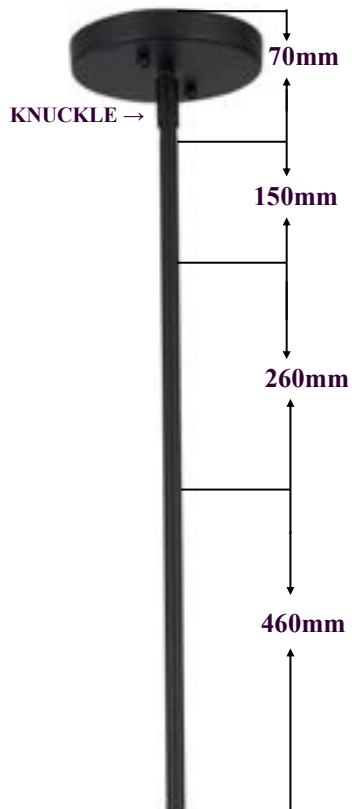

**1001143**  
**DALTON**  
**1/LT W/B**  
**MATT BLACK**  
E27  
FRAME SIZE  
H - 32cm W - 13cm  
P - 17cm



**- Pendant Range -**

**Aspen  
Range**

**1001065**

**ASPEN  
5/LT PND  
MATT BLACK  
E27  
FRAME SIZE  
H - 28cm W - 70cm  
RODS & KNUCKLE  
AS PER  
3/LT PENDANT**

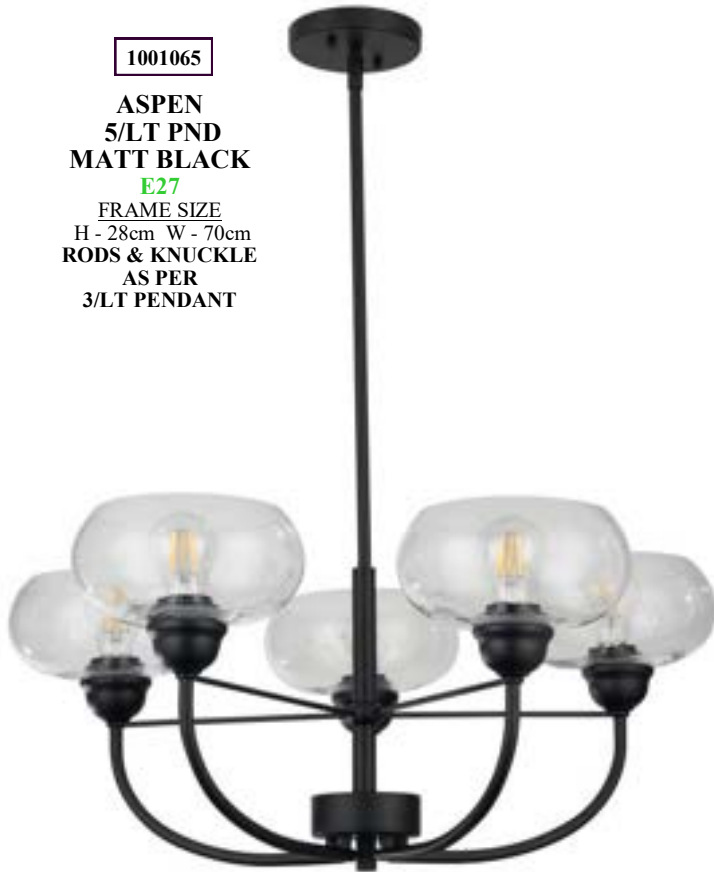

*Globes  
Not  
Supplied*

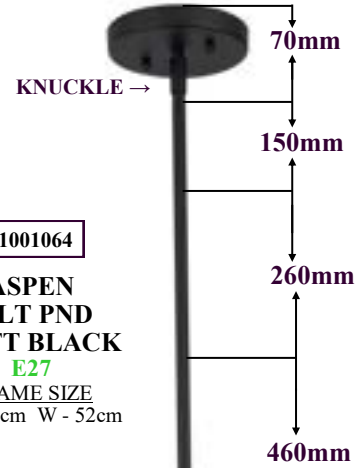

**1001064**

**ASPEN  
3/LT PND  
MATT BLACK  
E27  
FRAME SIZE  
H - 28cm W - 52cm**



**1001062**

**ASPEN  
1/LT W/B  
MATT BLACK  
E27  
FRAME SIZE  
H - 29cm W - 20cm  
P - 23cm**



**1001063**

**ASPEN BENCH  
3/LT PND  
MATT BLACK  
E27  
FRAME SIZE  
H - 23cm W - 20cm  
L - 84cm  
RODS & KNUCKLE  
AS PER  
3/LT PENDANT**



**- Pendant Range -**

***Dallas  
Bronze  
Range***

1000127

**DALLAS BRONZE  
5/LT PND**  
E27  
FRAME SIZE -  
H - 68cm W - 60cm



1000125

**DALLAS BRONZE  
3/LT PND**  
E27  
FRAME SIZE -  
H - 61cm W - 45cm



***\*Features\*  
Classic  
Hampton  
&  
Provincial  
Style***

**- NOTE -**

**Supplied  
With  
1 MT  
Chain  
&  
Canopy**

1000129

**DALLAS BRONZE  
6/LT + 3/LT = 9/LT PND**  
E27  
FRAME SIZE -  
H - 79cm W - 75cm



- Pendant Range -

*Dallas  
Bronze  
Range*

1000141

**DALLAS BRONZE**  
**1/LT W/B**  
**E27**  
FRAME SIZE  
H - 24cm W - 15cm  
P - 21cm



1000135

**DALLAS BRONZE**  
**SEMI FLUSH 2/LT E27**  
FRAME SIZE - H - 34cm W - 39cm

*OYSTER  
SHOWN  
WITH  
LIGHTS ON*

- NOTE -

-  
Supplied  
With  
1MT  
Chain  
&  
Canopy  
-



1000131

**DALLAS BRONZE**  
**3/LT OYSTER E27**  
FRAME SIZE - H - 19cm W - 41cm



1000139

**DALLAS BRONZE**  
**SINGLE SUSPENSION**  
**3/LT E27**  
FRAME SIZE -  
H - 63cm W - 40cm

**- Pendant Range -**

***Dallas  
Chrome  
Range***

1000126

**DALLAS CHROME  
5/LT PND**

**E27**

FRAME SIZE -  
H - 68cm W - 60cm



1000124

**DALLAS CHROME  
3/LT PND**

**E27**

FRAME SIZE -  
H - 61cm W - 45cm



***\*Features\*  
Classic  
Hampton  
&  
Provincial  
Style***

**- NOTE -**

**Supplied  
With  
1 MT  
Chain  
&  
Canopy**



1000128

**DALLAS CHROME  
6/LT + 3/LT = 9/LT PND**

**E27**

FRAME SIZE -  
H - 79cm W - 75cm



**- Pendant Range -**

***Dallas  
Chrome  
Range***

1000140

**DALLAS CHROME  
1/LT W/B  
E27  
FRAME SIZE  
H - 24cm W - 15cm  
P - 21cm**



**OYSTER  
&  
W/B  
SHOWN  
WITH  
LIGHTS ON**

1000134

**DALLAS CHROME  
SEMI FLUSH 2/LT E27  
FRAME SIZE - H - 34cm W - 39cm**



**- NOTE -**

**-  
Supplied  
With  
1MT  
Chain  
&  
Canopy  
-**

1000130

**DALLAS CHROME  
3/LT OYSTER E27  
FRAME SIZE - H - 19cm W - 41cm**



1000138

**DALLAS CHROME  
SINGLE SUSPENSION  
3/LT E27  
FRAME SIZE -  
H - 63cm W - 40cm**



- Pendant Range -

*Houston  
Bronze  
Range*

1000254

**HOUSTON  
5/LT PND  
BRONZE**

**E27**

FRAME SIZE -  
H - 59cm W - 58cm

1000250

**HOUSTON  
3/LT PND  
BRONZE**

**E27**

FRAME SIZE -  
H - 49cm W - 44cm



- NOTE -

Supplied  
With  
1 MT  
Chain  
&  
Canopy

1000255

**HOUSTON  
6+3 = 9/LT PND  
BRONZE**

**E27**

FRAME SIZE -  
H - 76cm W - 66cm

**- Pendant Range -**

***Houston  
Bronze  
Range***



1000264

**HOUSTON  
1/LT W/B  
BRONZE**

**E27**

**FRAME SIZE**

H - 23cm W - 18cm  
P - 24cm



1000258

**HOUSTON  
SEMI FLUSH  
2/LT BRONZE**

**E27**

**FRAME SIZE -**

H - 39cm W - 33cm



1000262

**HOUSTON  
SINGLE  
SUSPENSION  
2/LT  
BRONZE**

**E27**

**FRAME SIZE -**

H - 57cm W - 33cm

**- NOTE -**

**-  
Supplied  
With  
1MT  
Chain  
&  
Canopy**

-



1000248

**HOUSTON  
3/LT FLUSH  
BRONZE**

**E27**

**FRAME SIZE -**

H - 49cm W - 44cm

***Features  
Opal  
Matt  
Glassware***



1000252

**HOUSTON  
5/LT FLUSH  
BRONZE**

**E27**

**FRAME SIZE -**

H - 59cm W - 58cm



**- Pendant Range -**

***Houston  
Chrome  
Range***

1000253

**HOUSTON  
5/LT PND  
CHROME**

**E27**

**FRAME SIZE -  
H - 59cm W - 58cm**

1000249

**HOUSTON  
3/LT PND  
CHROME**

**E27**

**FRAME SIZE -  
H - 49cm W - 44cm**



**- NOTE -**

**-  
Supplied  
With  
1 MT  
Chain  
&  
Canopy  
-**

1000256

**HOUSTON  
6+3 = 9/LT PND  
CHROME**

**E27**

**FRAME SIZE -  
H - 76cm W - 66cm**



**- Pendant Range -**

***Houston  
Chrome  
Range***



1000263

**HOUSTON  
1/LT W/B  
CHROME**

**E27**

FRAME SIZE

H - 23cm W - 18cm  
P - 24cm



1000257

**HOUSTON  
SEMI FLUSH  
2/LT CHROME**

**E27**

FRAME SIZE -

H - 39cm W - 33cm



**- NOTE -**

-

**Supplied**

**With**

**1 MT**

**Chain**

**&**

**Canopy**

-



1000247

**HOUSTON  
3/LT FLUSH  
CHROME**

**E27**

FRAME SIZE -

H - 49cm W - 44cm

***Features  
Opal  
Matt  
Glassware***



1000251

**HOUSTON  
5/LT FLUSH  
CHROME**

**E27**

FRAME SIZE -

H - 59cm W - 58cm

1000261

**HOUSTON  
SINGLE  
SUSPENSION  
2/LT  
CHROME**

**E27**

FRAME SIZE -

H - 57cm W - 33cm



**- Pendant Range -**

***Benson  
Bronze  
Range***

**1001169**

**BENSON UP  
3/LT PND  
BRONZE  
E27  
FRAME SIZE -  
H - 27cm W - 42cm  
RODS & KNUCKLE  
AS PER  
3LT PND**



**1001173**  
**BENSON DOWN  
3/LT PND  
BRONZE  
E27  
FRAME SIZE -  
H - 35cm W - 42cm**



***Benson  
1/LT W/B  
Can Be  
Installed  
Either  
Facing Up  
Or  
Facing Down***



**1001167**

**BENSON  
DOWN  
1/LT W/B  
BRONZE  
E27  
FRAME SIZE  
H - 26cm  
W - 15cm  
P - 22cm**



***\*Features\*  
Classic  
Hampton  
&  
Provincial  
Style***

**1001171**

**BENSON UP  
5/LT PND  
BRONZE  
E27  
FRAME SIZE -  
H - 30cm W - 60cm**



**1001175**

**BENSON DOWN  
5/LT PND  
BRONZE  
E27  
FRAME SIZE -  
H - 36cm W - 60cm**



**- Pendant Range -**



**Benson  
1/LT W/B  
Can Be  
Installed  
Either  
Facing Up  
Or  
Facing Down**

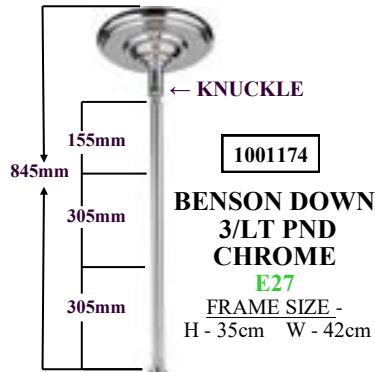

**Benson  
Chrome  
Range**



**1001168**  
**BENSON  
UP  
1/LT W/B  
CHROME  
E27**  
**FRAME SIZE**  
H - 26cm  
W - 15cm  
P - 22cm



**1001170**  
**BENSON UP  
3/LT PND  
CHROME  
E27**  
**FRAME SIZE -**  
H - 27cm W - 42cm  
**RODS & KNUCKLE  
AS PER  
3LT PND**

**\*Features\***  
**Classic  
Hampton  
&  
Provincial  
Style**

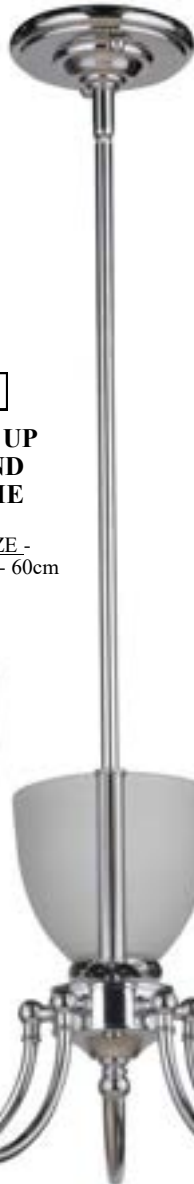

**1001172**  
**BENSON UP  
5/LT PND  
CHROME  
E27**  
**FRAME SIZE -**  
H - 30cm W - 60cm



**1001176**  
**BENSON DOWN  
5/LT PND  
E27  
E-27 L/H**  
**FRAME SIZE -**  
H - 36cm W - 60cm



**- Pendant Range -**

**Lakewood  
Range**

1001296

**LAKWOOD  
SEMI FLUSH  
4/LT PND  
MATT BLACK**

E14

FRAME SIZE  
H - 32cm W - 44cm



1001297

**LAKWOOD  
SUSPENSION  
4/LT PND  
MATT BLACK**

E14

FRAME SIZE  
H - 62cm W - 54cm



**- NOTE -**  
-  
Supplied  
With  
1 MT  
Chain  
&  
Canopy  
-

*Globes  
Not  
Supplied*

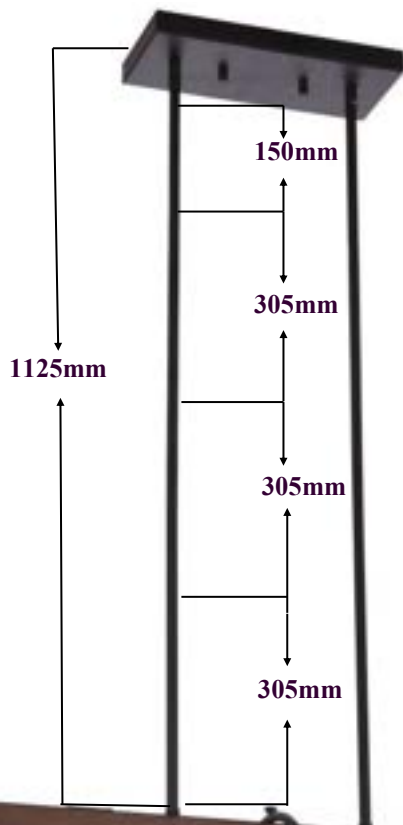

1001293

**LAKWOOD  
BENCH  
4/LT PND  
MATT BLACK**

E27

FRAME SIZE  
H - 27cm W - 31cm  
L - 87cm



**- Pendant Range -**

**Lakewood  
Range**

1001292

**LAKWOOD  
3/LT PND  
MATT BLACK**

**E14**

**FRAME SIZE**

H - 56cm W - 54cm



**- NOTE -**

**Supplied  
With  
1MT  
Chain  
&  
Canopy**

1001294

**LAKWOOD  
5/LT PND  
MATT BLACK**

**E14**

**FRAME SIZE**

H - 75cm W - 65cm



1001295

**LAKWOOD  
8/LT PND  
MATT BLACK**

**E14**

**FRAME SIZE**

H - 97cm W - 80cm



***Globes  
Not  
Supplied***

1001291

**LAKWOOD  
1/LT W/B  
MATT BLACK**

**E14**

**FRAME SIZE**

H - 19cm W - 13cm

P - 16cm



- Chandelier & Crystal Range -

*Salzburg  
Range*

*\*Features\*  
Classic  
French  
Provincial  
Style*



1000800

**SALZBURG  
2/LT W/B  
BRONZE**

**E14**

**FRAME SIZE**  
H - 48cm W - 30cm  
P - 18cm



1000806

**SALZBURG  
24/LT PND  
BRONZE**

**E14**

**FRAME SIZE**  
H - 126cm  
W - 103cm

*Globes  
Not  
Supplied*

*Quality  
Glass  
Crystal*

*Bronze  
Finish*

**- Chandelier & Crystal Range -**

**Salzburg  
Range**

**1000804**

**SALZBURG  
8/LT PND  
BRONZE  
E14  
FRAME SIZE -  
H - 73cm  
W - 72cm**



**NOTE -**  
*Flush Plate Conversion Kit  
Available  
For  
3/LT-5/LT-8LT*

**1000801**

**SALZBURG  
3/LT PND  
BRONZE  
E14  
FRAME SIZE -  
H - 45cm W - 50cm**



**- NOTE -**  
-  
*Supplied  
With  
1 MT  
Chain  
&  
Canopy*  
-

**Quality  
Glass  
Crystal**

**1000803**

**SALZBURG  
5/LT PND  
BRONZE  
E14  
FRAME SIZE  
H - 55cm  
W - 55cm**



*Globes  
Not  
Supplied*

**1000805**

**SALZBURG  
12/LT PND  
BRONZE  
E14  
FRAME SIZE  
H - 106cm  
W - 83cm**

# - Chandelier & Crystal Range -

## *Louis 15th Range*



1000298

LOUIS 15th - 2/LT  
W/B BRONZE

E14

FRAME SIZE  
H - 43cm W - 34cm

- NOTE -  
-  
Supplied  
With  
1MT  
Chain  
&  
Canopy  
-

1000295

LOUIS 15th - 3/LT  
PEND BRONZE

E14

FRAME SIZE  
H - 70cm W - 45cm

- NOTE -  
-  
Supplied  
With  
1MT  
Chain  
&  
Canopy  
-



1000292

LOUIS 15th 24/LT  
(12/LT + 6/LT + 6/LT) 3-TIER  
PND BRONZE E14

FRAME SIZE - H - 170cm W - 140cm

*Globes  
Not  
Supplied*

**- Chandelier & Crystal Range -**

1000297

**LOUIS 15th - 6/LT  
PEND BRONZE**

**E14**

FRAME SIZE -  
H - 93cm W - 72cm

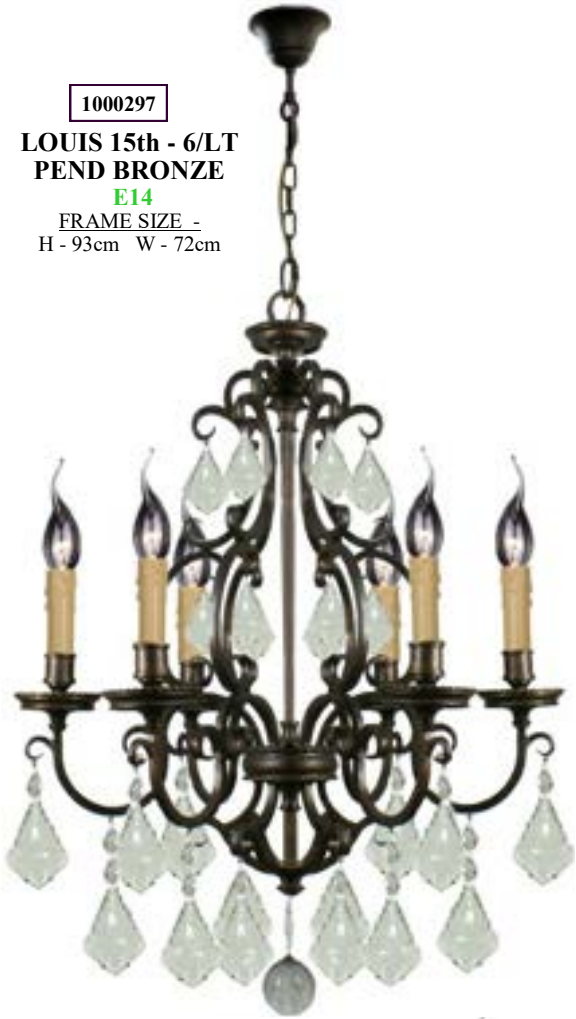

*Flush Plate  
Conversion Kit  
Available For  
3/LT-5/LT  
& 6/LT*

1000296

**LOUIS 15th - 5/LT  
PEND BRONZE**

**E14**

FRAME SIZE  
H - 74cm W - 63cm



- NOTE -

-  
Supplied  
With  
1 MT  
Chain  
&  
Canopy  
-

*Quality  
Glass  
Crystal*

*\*Features\*  
Classic  
French  
Provincial  
Style*

1000294

**LOUIS 15th - 15/LT  
(10/LT + 5/LT) 2-TIER  
PND BRONZE**

**E14**

FRAME SIZE  
H - 126cm W - 102cm



*Globes  
Not  
Supplied*

# - Chandelier & Crystal Range -

## *Odeon Range*

1000136

ODEON  
MEDIUM 3/LT  
BRONZE  
E14  
FRAME SIZE  
H - 35cm W - 40cm

- NOTE -

Supplied  
With  
1 MT  
Chain  
&  
Canopy

1000137

ODEON  
LARGE 6/LT  
BRONZE  
E14  
FRAME SIZE  
H - 50cm W - 51cm



*Globes  
Not  
Supplied*

*Quality  
Glass  
Crystal*

- NOTE -

Supplied  
With  
1 MT  
Chain  
&

Flat Ceiling Plate  
Size -  
L - 77cm W - 11cm  
D - 2cm

1001135

ODEON  
BENCH 12/LT  
BRONZE  
E14  
FRAME SIZE  
H - 40cm W - 36cm  
L - 125cm

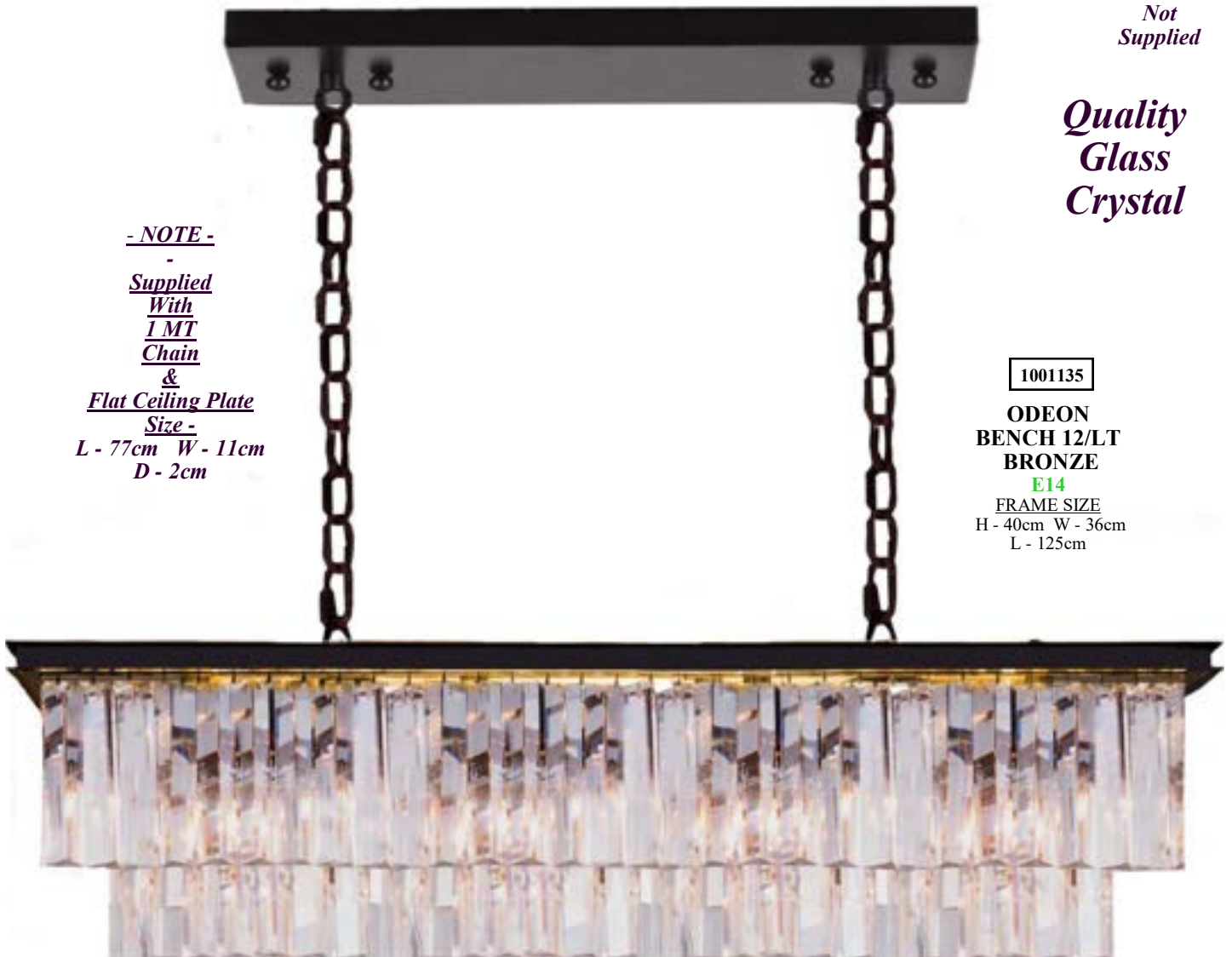

**- Chandelier & Crystal Range -**

***Cascade  
Range***

1000096

**CASCADE  
SMALL 35cm  
BASKET 3/LT  
ARCHAIZE  
BRONZE**

**E14**

**FRAME SIZE**

H - 47cm

W - 35cm



1000095

**CASCADE  
MEDIUM 45cm  
BASKET 6/LT  
ARCHAIZE  
BRONZE**

**E14**

**FRAME SIZE**

H - 57cm

W - 45cm



*Globes  
Not  
Supplied*

**- NOTE -**

**-  
Supplied  
With  
1/2 MT  
Chain  
&  
Canopy  
-**

1000094

**CASCADE  
LARGE 55cm  
BASKET 10/LT  
ARCHAIZE  
BRONZE**

**E14**

**FRAME SIZE**

H - 67cm

W - 55cm

***High  
Quality  
Glass  
Tear  
Drops***



**- Chandelier & Crystal Range -**

**Marseilles  
Basket  
Range**

*Quality  
Glass  
Crystal*

1000807

**MARSEILLES  
BASKET  
LARGE  
8/LT  
BRONZE  
E14  
FRAME SIZE  
H - 90cm  
W - 53cm**

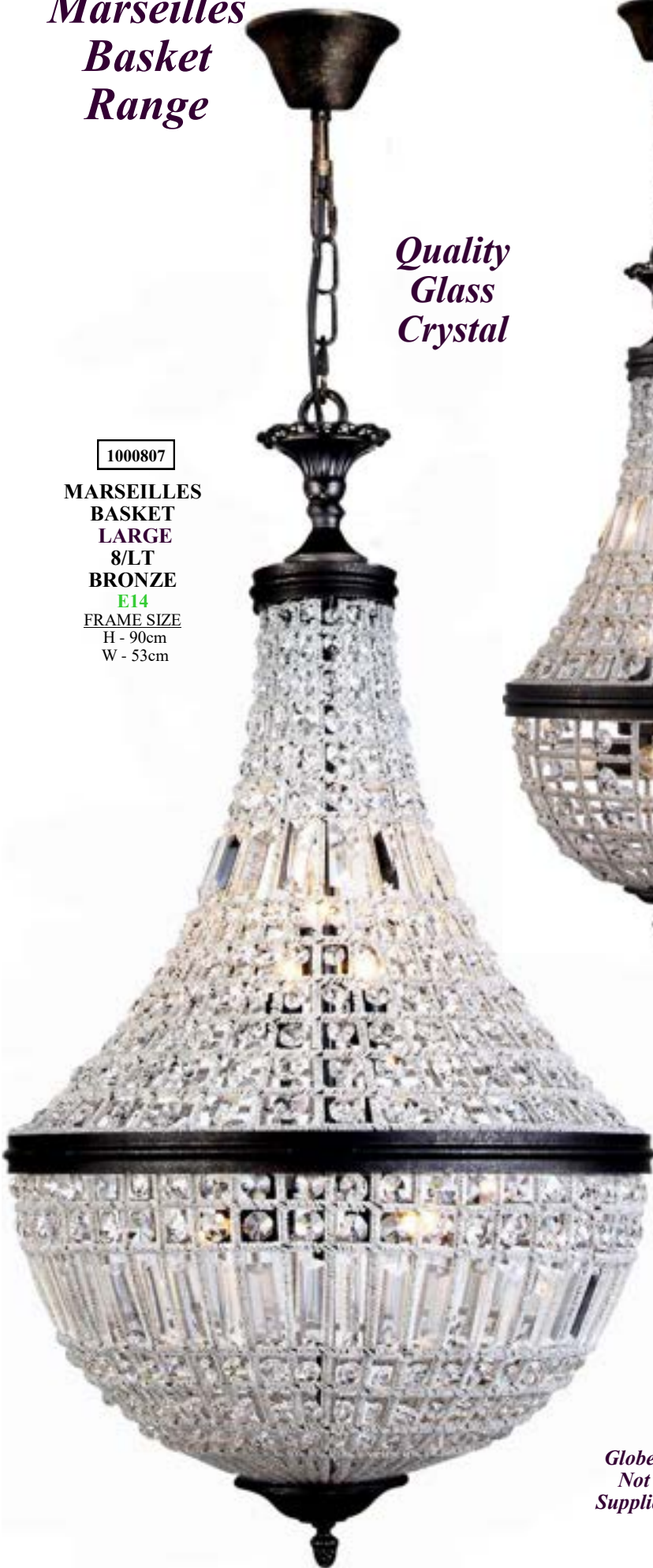

1000809

**MARSEILLES  
BASKET  
SMALL  
6/LT  
BRONZE  
E14  
FRAME SIZE  
H - 65cm  
W - 34cm**



**- NOTE -  
-  
Supplied  
With  
1 MT  
Chain  
&  
Canopy  
-**

1000808

**MARSEILLES  
BASKET  
MEDIUM  
6/LT  
BRONZE  
E14  
FRAME SIZE  
H - 76cm  
W - 44cm**



*Globes  
Not  
Supplied*



**- Chandelier & Crystal Range -**

**High  
Quality  
Crystal**

**Marseilles  
Ball  
Range**

1000810

**MARSEILLES  
BALL  
LARGE  
3/LT BRONZE**

**E14**

FRAME SIZE  
H - 58cm W - 45cm



**Quality  
Glass  
Crystal**

**- NOTE -**

**-**

**Supplied  
With  
1 MT  
Chain  
&  
Canopy**

**-**

**Globes  
Not  
Supplied**

1000811

**MARSEILLES  
BALL  
SMALL 1/LT BRONZE**

**E27**

FRAME SIZE  
H - 38cm W - 31cm



**- Chandelier & Crystal Range -**

***Celestial  
Chrome  
Range***

**- NOTE -**

**Supplied  
With  
1/2 MT  
Chain  
&  
Canopy**

***Quality  
Glass  
Crystal***



**1001100**

**CELESTIAL  
CHROME  
PND 9/LT 6-TIER**

**E14**

**FRAME SIZE  
H - 68cm W - 39cm**



**1001096**

**CELESTIAL  
CHROME  
FLUSH  
6/LT 5-TIER**

**E14**

**FRAME SIZE  
H - 40cm W - 40cm**

***Globes  
Not  
Supplied***



**1001101**

**CELESTIAL  
CHROME  
W/B 2/LT 2-TIER**

**E14**

**FRAME SIZE  
H - 24cm W - 24cm  
P - 14cm**

**- Chandelier & Crystal Range -**

***Celestial  
Chrome  
Range***



1001098

**CELESTIAL  
CHROME  
PND 4/LT 3-TIER**  
E14  
FRAME SIZE  
H - 35cm W - 29cm



1001099

**CELESTIAL  
CHROME  
PND 5/LT 4-TIER**  
E14  
FRAME SIZE  
H - 43cm W - 39cm

**- NOTE -**  
**-**  
**Supplied**  
**With**  
**1/2 MT**  
**Chain**  
**&**  
**Canopy**  
**-**

*Globes  
Not  
Supplied*



1001097

**CELESTIAL  
CHROME  
PND 10/LT 5-TIER**  
E14  
FRAME SIZE  
H - 50cm W - 49cm

***Quality  
Glass  
Crystal***

**- Chandelier & Crystal Range -**

***Celestial  
Matt Black  
Range***

**- NOTE -**

**Supplied  
With  
1/2 MT  
Chain  
&  
Canopy**

***Quality  
Glass  
Crystal***



**1001094**

**CELESTIAL  
MATT BLACK  
PND 9/LT 6-TIER**

**E14**

**FRAME SIZE  
H - 68cm W - 39cm**



**1001090**

**CELESTIAL  
MATT BLACK  
FLUSH  
6/LT 5-TIER**

**E14**

**FRAME SIZE  
H - 40cm W - 40cm**

***Globes  
Not  
Supplied***

***New***



**1001095**

**CELESTIAL  
MATT BLACK  
W/B 2/LT 2-TIER**

**E14**

**FRAME SIZE  
H - 24cm W - 24cm  
P - 14cm**

**- Chandelier & Crystal Range -**

***Celestial  
Matt Black  
Range***

1001092

**CELESTIAL  
MATT BLACK  
PND 4/LT 3-TIER**

**E14**

FRAME SIZE  
H - 35cm W - 29cm

1001093

**CELESTIAL  
MATT BLACK  
PND 5/LT 4-TIER**

**E14**

FRAME SIZE  
H - 43cm W - 39cm



***New***

**- NOTE -**

**Supplied  
With  
1/2 MT  
Chain  
&  
Canopy**

***Globes  
Not  
Supplied***

1001091

**CELESTIAL  
MATT BLACK  
PND 10/LT 5-TIER**

**E14**

FRAME SIZE  
H - 50cm W - 49cm



***Quality  
Glass  
Crystal***

# - Chandelier & Crystal Range -

## *Rotondo Range*

*Globes  
Not  
Supplied*

1000428

**ROTONDO  
PENDANT 6/LT  
LARGE 50cm  
CHROME**

**E14**

FRAME SIZE

H - 17cm

W - 50cm

ADD CABLE

SUSPENSION

88cm



1000429

**ROTONDO  
PENDANT 5/LT  
MEDIUM 40cm  
CHROME**

**E14**

FRAME SIZE

H - 17cm

W - 40cm

ADD CABLE

SUSPENSION

88cm



*Quality  
Glass  
Crystal*

# - Chandelier & Crystal Range -

## *Rotondo Range*



1000427

**ROTONDO  
FLUSH 3/LT  
SMALL 30cm  
CHROME**

**E14**

**FRAME SIZE  
H - 18cm W - 30cm**

*High  
Quality  
Crystal*

1000426

**ROTONDO  
FLUSH 5/LT  
MEDIUM 40cm  
CHROME**

**E14**

**FRAME SIZE  
H - 18cm W - 40cm**



*Quality  
Glass  
Crystal*

*Globes  
Not  
Supplied*



1000425

**ROTONDO  
FLUSH 6/LT  
LARGE 50cm  
CHROME**

**E14**

**FRAME SIZE -  
H - 18cm W - 50cm**

**- Chandelier & Crystal Range -**

**Emporia  
Range**



**1001177**  
EMPORIA  
PND 3/LT 4 TIER  
CHROME  
E14  
FRAME SIZE  
H - 31cm W - 34cm

**- NOTE -**  
-  
**Supplied**  
**With**  
**86 CM**  
**Chain**  
**+**  
**Canopy**

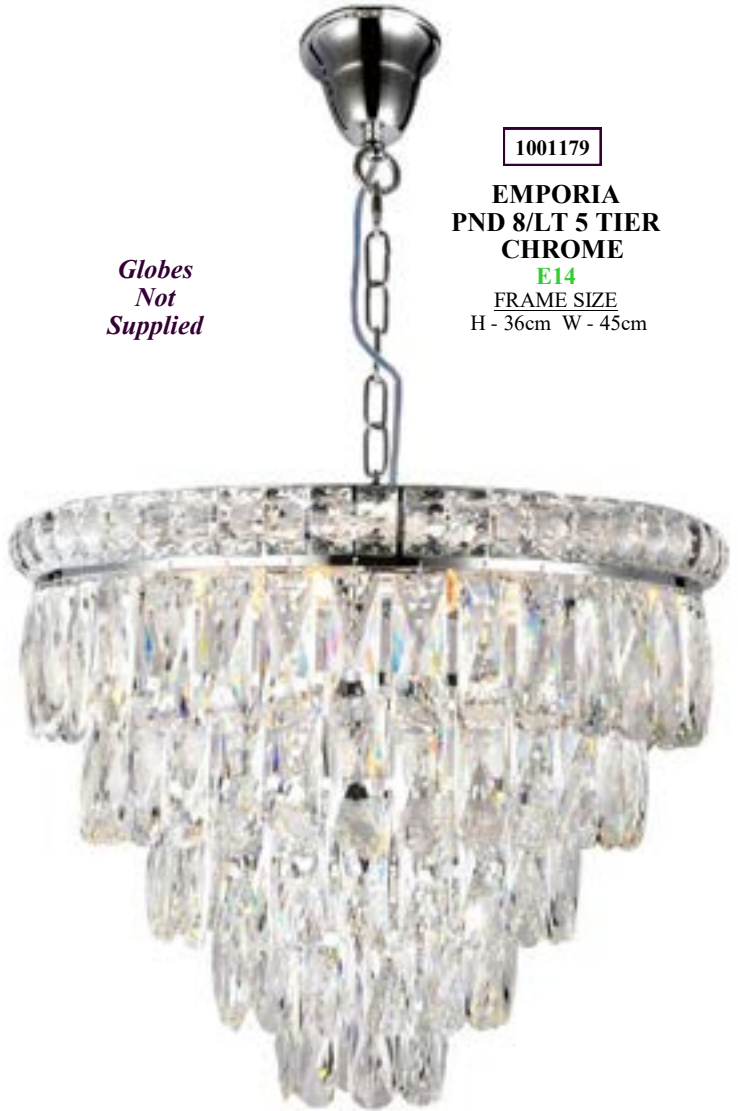

**1001179**  
EMPORIA  
PND 8/LT 5 TIER  
CHROME  
E14  
FRAME SIZE  
H - 36cm W - 45cm

*Globes  
Not  
Supplied*

**Quality  
Glass  
Crystal**



**1001180**  
EMPORIA  
W/B 2/LT 3 TIER  
CHROME  
E14  
FRAME SIZE -  
H - 28cm W - 28cm  
P - 17cm



**1001178**  
EMPORIA  
FLUSH 5/LT 5 TIER  
CHROME  
E14  
FRAME SIZE  
H - 39cm W - 45cm



**- Chandelier & Crystal Range -**

*Quality  
Glass  
Crystal*

*Waterfall  
Range*



**1001576**

**WATERFALL  
FLUSH 5/LT -  
4 TIER  
CHROME**  
E14  
FRAME SIZE  
H - 40cm W - 41cm



**1001575**

**WATERFALL  
PND 3/LT - 3 TIER  
CHROME**  
E14  
FRAME SIZE  
H - 33cm W - 31cm

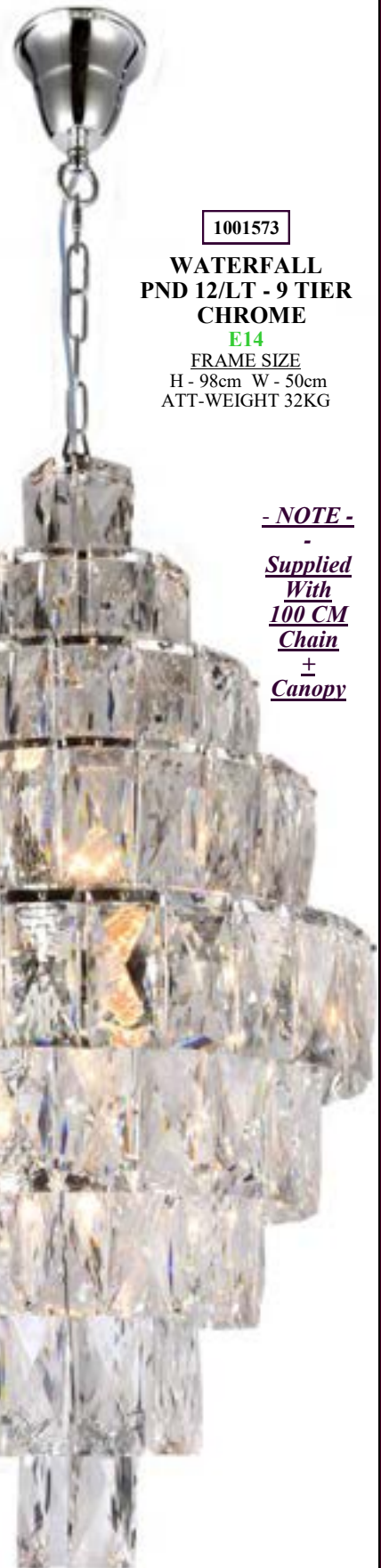

**1001573**

**WATERFALL  
PND 12/LT - 9 TIER  
CHROME**  
E14  
FRAME SIZE  
H - 98cm W - 50cm  
ATT-WEIGHT 32KG

*- NOTE -  
-  
Supplied  
With  
100 CM  
Chain  
±  
Canopy*



**1001574**

**WATERFALL  
W/B 2/LT  
3 TIER  
CHROME**  
E14  
FRAME SIZE  
H - 31cm W - 26cm  
P - 16cm

*- NOTE -  
-  
Supplied  
With  
86 CM  
Chain  
±  
Canopy*



**1001577**

**WATERFALL  
PND 5/LT - 4 TIER  
CHROME**  
E14  
FRAME SIZE  
H - 37cm W - 41cm

*Globes  
Not  
Supplied*

# - Chandelier & Crystal Range -

## *Classique Range*

1000113

CLASSIQUE  
BASKET  
27/LT 100cm  
CHROME  
E14  
FRAME SIZE  
H - 145cm W - 100cm



1001117

CLASSIQUE  
BASKET  
18/LT 75cm  
CHROME  
E14  
FRAME SIZE  
H - 120cm W - 75cm

- NOTE -  
-  
Supplied  
With  
1 MT  
Chain  
&  
Canopy  
-

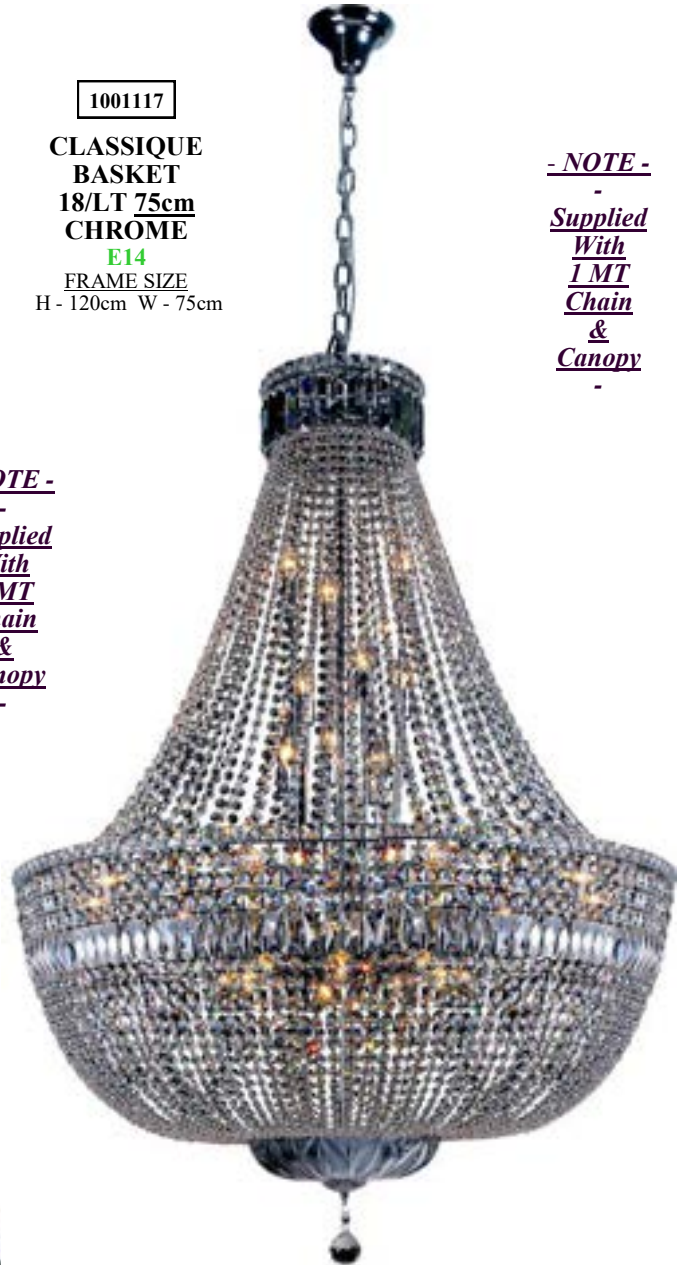

- NOTE -  
-  
Supplied  
With  
1 MT  
Chain  
&  
Canopy  
-

*Quality  
Glass  
Crystal*

*Globes  
Not  
Supplied*

**- Chandelier & Crystal Range -**

***Classique  
Range***

*Globes  
Not  
Supplied*

***Quality  
Glass  
Crystal***

**1000112**

**CLASSIQUE  
BASKET  
5/LT 40cm  
CHROME**

**E14**

**FRAME SIZE**

H - 68cm W - 40cm



**- NOTE -**

**-  
Supplied  
With  
1/2 MT  
Chain  
&  
Canopy  
-**

**1000111**

**CLASSIQUE  
BASKET  
6/LT 50cm  
CHROME**

**E14**

**FRAME SIZE**

H - 71cm W - 50cm



**1000114**

**CLASSIQUE  
FLUSH 6/LT  
LARGE 50cm CHROME E14**  
FRAME SIZE - H - 34cm W - 50cm



**1000115**

**CLASSIQUE  
FLUSH 5/LT  
MEDIUM 40cm CHROME E14**  
FRAME SIZE - H - 30cm W - 40cm



**1000116**

**CLASSIQUE  
FLUSH 3/LT  
SMALL 30cm CHROME E14**  
FRAME SIZE - H - 28cm W - 30cm

**- Chandelier & Crystal Range -**

**Zurich  
Chrome  
Range**

*Globes  
Not  
Supplied*

1000606

**ZURICH CHROME 3/LT  
CHANDELIER**

**E14**  
FRAME SIZE  
H - 50cm W - 43cm



1000610

**ZURICH CHROME 2/LT  
WALL BRACKET**

**E14**  
FRAME SIZE  
H - 27cm W - 38cm P - 20cm



**- NOTE -**

**Supplied  
With  
1/2 MT  
Chain  
&  
Canopy**



1000609

**ZURICH CHROME 18/LT  
(12/LT + 6/LT)  
CHANDELIER**

**E14**  
FRAME SIZE  
H - 82cm W - 91cm

**\* Attention \***

**RE - Metal arm chandeliers -**  
*The arms are malleable and may move in transit,  
please open box & inspect arms before giving to your customer.  
Report any breakage immediately for replacement of arms or fitting.  
No claim for electrical work will be recognized  
if inspection is not made.*

**- Chandelier & Crystal Range -**

**Zurich  
Chrome  
Range**

1000607

**ZURICH CHROME 5/LT  
CHANDELIER**

E14

FRAME SIZE  
H - 52cm W - 45cm

*Globes  
Not  
Supplied*



1000608

**ZURICH CHROME 9/LT  
(6/LT + 3/LT)  
CHANDELIER**

E14

FRAME SIZE  
H - 65cm W - 55cm



*\*Features\*  
Classic  
Marie Therese Style  
Quality Glass  
Crystal Drops*

1000617

**ZURICH CHROME 8/LT  
CHANDELIER**

E14

FRAME SIZE  
H - 65cm W - 72cm



**- NOTE -**

**-  
Supplied  
With  
1/2 MT  
Chain  
&  
Canopy  
-**

**- Chandelier & Crystal Range -**

**Zurich  
Gold  
Range**

*New*



1000628

**ZURICH GOLD 2/LT  
WALL BRACKET**

**E14**  
FRAME SIZE  
H - 27cm W - 38cm  
P - 20cm

**- NOTE -**

**-  
Supplied  
With  
1/2 MT  
Chain  
&  
Canopy  
-**

1000623

**ZURICH GOLD 3/LT  
CHANDELIER**

**E14**  
FRAME SIZE  
H - 50cm W - 43cm



*Globes  
Not  
Supplied*



1000627

**ZURICH GOLD 18/LT  
(12/LT + 6/LT)  
CHANDELIER**

**E14**  
FRAME SIZE  
H - 82cm W - 91cm

***\* Attention\****

***RE - Metal arm chandeliers -***

*The arms are malleable and may move in transit,  
please open box & inspect arms before giving to your customer.  
Report any breakage immediately for replacement of arms or fitting.  
No claim for electrical work will be recognized if inspection is not made.*

# - Chandelier & Crystal Range -

## Zurich Gold Range

New

1000624

ZURICH GOLD 5/LT  
CHANDELIER

E14

FRAME SIZE

H - 52cm W - 45cm

Globes  
Not  
Supplied



1000626

ZURICH GOLD 9/LT  
(6/LT + 3/LT)  
CHANDELIER

E14

FRAME SIZE

H - 65cm W - 55cm



*\*Features\**

*Classic*

*Marie Therese Style*

*Quality Glass*

*Crystal Drops*

1000625

ZURICH GOLD 8/LT  
CHANDELIER

E14

FRAME SIZE

H - 65cm W - 72cm



- NOTE -

-

Supplied

With

1/2 MT

Chain

&

Canopy

-

- Chandelier & Crystal Range -

*Chopin  
&  
Mozart  
Range*

1000110

CHOPIN  
1/LT  
BASKET  
CROME  
E27  
FRAME  
SIZE  
H - 44cm  
W - 24cm

- NOTE -  
-  
Supplied  
With  
1/2 MT  
Chain  
&  
Canopy  
-



1000341

MOZART  
1/LT  
BASKET  
CHROME  
E27  
FRAME SIZE  
H - 54cm  
W - 28cm

- NOTE -  
-  
Supplied  
With  
1/2 MT  
Chain  
&  
Canopy  
-

*Globes  
Not  
Supplied*



*Quality  
Glass  
Crystal*



# - Exterior Range -

## *Solid Brass Range*



1001202

**HARBOUR SOLID BRASS**  
 E27 - 60W/LED 10W - WEIGHT 1.2KG  
FRAME SIZE  
 H - 260mm W - 109mm P - 130mm

- \* Attention \***
- These products are designed to age in a patina finish.
- The integrity of the product will not alter.
- Solid high grade cast brass material used.
- Robust yet hand crafted ensuring long life.
- Can withstand ocean side locations but will age/patina with time.
- Hand polishing required to keep brass look.
- These products are not lacquered purposely to age/patina finish.
- \* Suggested additional care for the Purchaser to undertake \***
- Lacquer spray unit without glass to maintain finish for longer period if patina finish not preferred.
- \* Electrician Note:**
- Conduit side entry.



1001206

**REGATTA SOLID BRASS**  
 E27 - 60W/LED 10W / WEIGHT 1KG  
FRAME SIZE  
 H - 209mm W - 109mm



1001205

**NAVIGATOR SOLID BRASS**  
 E27 - 60W/LED 10W - WEIGHT 1KG  
FRAME SIZE  
 H - 109mm W - 209mm P - 120mm

*Globes  
 Not  
 Supplied*

**QUALITY  
 SOLID  
 CAST  
 BRASS**



1001201

**ADMIRAL SOLID BRASS**  
 E27 - 60W/LED 10W - WEIGHT 1KG  
FRAME SIZE  
 H - 109mm W - 209mm P - 120mm



1001203

**MARINA SOLID BRASS**  
 E27 - 60W/LED 10W - WEIGHT 1KG  
FRAME SIZE - H - 180mm W - 180mm P - 87mm

**IP - 56  
 Rated**



1001204

**MARITIME SOLID BRASS**  
 E27 - 60W/LED 10W - WEIGHT 1KG  
FRAME SIZE - H - 180mm W - 180mm P - 87mm

**- Warranty Conditions -**

Any claim must be made within 12 Months from the date of purchase. To make a claim, take the product with a Receipt of proof of purchase to retailer.

**- Warranty Exclusions -**

1 - Fading due to weather exposure. 2 - Installation within 2km of salt water spray. 3 - Damage to product through accident, misuse or negligence.

**- Exterior Range -**

**Junction  
Range**

**Antique  
Black**



**1001235**

**JUNCTION  
MEDIUM  
SINGLE  
POST  
ON A  
STANDARD  
3 PIECE  
POST**

**E27**  
**FRAME SIZE**  
H - 233cm  
W - 29cm

**\* NOTE \***  
*Single  
Post  
Is  
Supplied  
With  
A  
Total  
3  
Pieces  
+  
Post Top  
-*



**- NOTE -**  
**Chain  
Pendant  
Is For  
Interior  
Use  
Only**

**-**  
**Supplied  
With A  
1 MT  
Chain**

**1001236**

**JUNCTION  
MEDIUM  
CHAIN PND**

**E27**  
**FRAME SIZE -**  
H - 48cm  
W - 29cm

*Globes  
Not  
Supplied*



**- NOTE -**  
**Rod  
Pendant  
Is For  
Exterior  
Use**

**1001237**

**JUNCTION  
MEDIUM  
ROD PND**

**E27**  
**FRAME SIZE**  
H - 48cm  
W - 29cm  
**+ 4 x 20cm RODS**  
**+ 1 x 5cm CAP**

**IP - 44  
Rated**

**- Warranty Conditions -**

Any claim must be made within 12 Months from the date of purchase.  
To make a claim, take the product with a Receipt of proof of purchase to retailer.

**- Warranty Exclusions -**

1 - Fading due to weather exposure. 2 - Installation within 2km of salt water spray.  
3 - Damage to product through accident, misuse or negligence.

**- Exterior Range -**

*Globes  
Not  
Supplied*

***Antique  
Black***

***IP - 44  
Rated***



**1001243**

**JUNCTION  
MEDIUM W/B**

**E27**

**FRAME SIZE**

H - 60cm W - 29cm  
P - 25cm



**1001244**

**JUNCTION  
SMALL W/B**

**E27**

**FRAME SIZE**

H - 50cm W - 20cm  
P - 24cm



**1001242**

**JUNCTION  
SMALL  
UNDER EAVE**

**E27**

**FRAME SIZE -**

H - 40cm W - 20cm



**1001241**

**JUNCTION  
MEDIUM  
UNDER EAVE**

**E27**

**FRAME SIZE -**

H - 48cm W - 29cm



**1001238**

**JUNCTION  
MEDIUM  
PILLAR MOUNT**

**E27**

**FRAME SIZE -**

H - 69cm W - 29cm



**1001239**

**JUNCTION  
SMALL  
PILLAR MOUNT**

**E27**

**FRAME SIZE -**

H - 59cm W - 20cm

**- Warranty Conditions -**

*Any claim must be made within 12 Months from the date of purchase.  
To make a claim, take the product with a Receipt of proof of purchase to retailer.*

**- Warranty Exclusions -**

*1 - Fading due to weather exposure. 2 - Installation within 2km of salt water spray.  
3 - Damage to product through accident, misuse or negligence.*

**- Exterior Range -**

**Kingdom  
Range**

**New**

**Antique  
Bronze**



**1000841**  
KINGDOM  
SINGLE  
POST  
ON A  
STANDARD  
3 PIECE  
POST  
E27  
FRAME SIZE  
H - 230cm  
W - 29cm

**\* NOTE \***  
Single  
Post  
Is  
Supplied  
With  
A  
Total  
3  
Pieces  
+  
Post Top  
-



**1000842**  
KINGDOM  
CHAIN PND  
E27  
FRAME SIZE -  
H - 54cm  
W - 29cm

**- NOTE -**  
Chain  
Pendant  
Is For  
Interior  
Use  
Only  
-  
Supplied  
With A  
1 MT  
Chain

**IP - 44  
Rated**

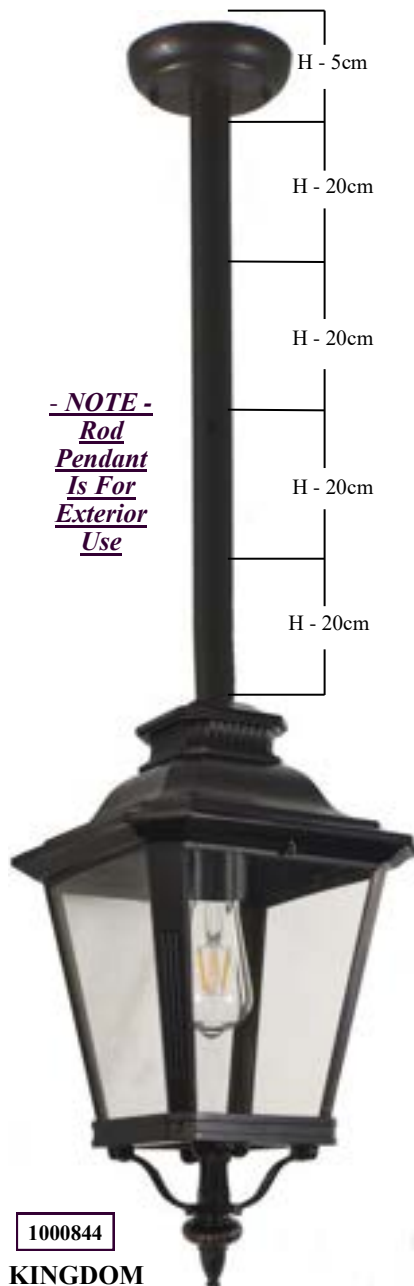

**1000844**  
KINGDOM  
ROD PND  
E27  
FRAME SIZE  
H - 50cm  
W - 29cm  
+ 4 x 20cm RODS  
+ 1 x 5cm CAP

**- NOTE -**  
Rod  
Pendant  
Is For  
Exterior  
Use

**1000846**  
KINGDOM  
LARGE  
ON  
DOMAIN  
POST  
E27

FRAME SIZE  
H - 276cm W - 29cm

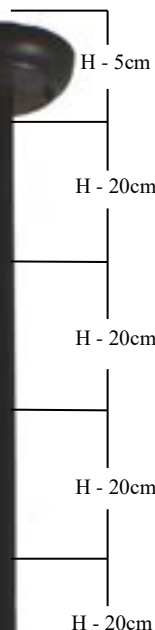

**\* NOTE \***  
If A  
Higher  
Post  
Height  
Is  
Required  
Please  
Use  
This  
Domain  
Post.  
Heavy  
Duty Thick  
Casting  
With  
4 Hole  
Floor  
Mounting



**- Warranty Conditions -**

Any claim must be made within 12 Months from the date of purchase.  
To make a claim, take the product with a Receipt of proof of purchase to retailer.

**- Warranty Exclusions -**

1 - Fading due to weather exposure. 2 - Installation within 2km of salt water spray.  
3 - Damage to product through accident, misuse or negligence.

**- Exterior Range -**

*Globes  
Not  
Supplied*

*New*



*Antique  
Bronze*

**IP - 44  
Rated**

**1000840**

**KINGDOM  
W/B**

**E27**

**FRAME SIZE**

**H - 60cm W - 29cm**

**P - 44cm**



**1000845**

**KINGDOM  
UNDER EAVE**

**E27**

**FRAME SIZE -**

**H - 54cm W - 29cm**



**1000843**

**KINGDOM  
PILLAR MOUNT**

**E27**

**FRAME SIZE -**

**H - 70cm W - 29cm**

**- Warranty Conditions -**

*Any claim must be made within 12 Months from the date of purchase.  
To make a claim, take the product with a Receipt of proof of purchase to retailer.*

**58**

**- Warranty Exclusions -**

*1 - Fading due to weather exposure. 2 - Installation within 2km of salt water spray.  
3 - Damage to product through accident, misuse or negligence.*

**- Exterior Range -**  
**Crown & Monarch**  
**Range**



**IP - 44**  
**Rated**

**Antique**  
**Bronze**

**New**

**1000832**  
**CROWN**  
**LARGE**  
**SINGLE**  
**STANDARD**  
**3 PIECE**  
**POST**  
**E27**  
**FRAME SIZE**  
 H - 236cm  
 W - 30cm

**\* NOTE \***  
 Single  
 Post  
 Is  
 Supplied  
 With  
 A  
 Total  
 3  
 Pieces  
 +  
 Post Top  
 -

**- NOTE -**  
Chain  
Pendant  
Is For  
Interior  
Use  
Only  
 -  
Supplied  
With A  
LMT  
Chain

**1000837**  
**CROWN**  
**LARGE**  
**ON**  
**DOMAIN**  
**POST**  
**E27**  
**FRAME SIZE**  
 H - 282cm W - 30cm

**\* NOTE \***  
If A  
Higher  
Post  
Height  
Is  
Required  
Please  
Use  
This  
Domain  
Post.  
Heavy  
Duty Thick  
Casting  
With  
4 Hole  
Floor  
Mounting



**1000833**  
**CROWN**  
**LARGE**  
**CHAIN PND**  
**E27**  
**FRAME SIZE -**  
 H - 61cm W - 30cm



**1000836**  
**CROWN**  
**LARGE**  
**ROD PND**  
**E27**  
**FRAME SIZE**  
 H - 61cm W - 30cm  
 + 4 x 20cm RODS  
 + 1 x 5cm CAP

**- NOTE -**  
Rod  
Pendant  
Is For  
Exterior  
Use

**- Exterior Range -**

*New*



**1000830**

**CROWN  
LARGE W/B**  
E27  
FRAME SIZE  
H - 74cm  
W - 30cm  
P - 37cm



**1000831**

**CROWN  
SMALL W/B**  
E27  
FRAME SIZE  
H - 57cm  
W - 20cm  
P - 26cm



**1000850**

**MONARCH  
SMALL W/B**  
E27  
FRAME SIZE  
H - 60cm  
W - 20cm  
P - 26cm

*IP - 44  
Rated*

*Antique  
Bronze*



**1000839**

**CROWN SMALL  
UNDER EAVE** E27  
FRAME SIZE -  
H - 40cm W - 20cm



**1000835**

**CROWN SMALL  
PILLAR MOUNT**  
E27  
FRAME SIZE -  
H - 60cm W - 20cm



**1000838**

**CROWN LARGE  
UNDER EAVE** E27  
FRAME SIZE -  
H - 56cm W - 30cm



**1000834**

**CROWN LARGE  
PILLAR MOUNT**  
E27  
FRAME SIZE -  
H - 76cm W - 30cm

**- Warranty Conditions -**

*Any claim must be made within 12 Months from the date of purchase.  
To make a claim, take the product with a Receipt of proof of purchase to retailer.*

**- Warranty Exclusions -**

**60**

*1 - Fading due to weather exposure. 2 - Installation within 2km of salt water spray.  
3 - Damage to product through accident, misuse or negligence.*

**- Exterior Range -**

**Albany  
Range**

**Antique  
Bronze**



1000030

**ALBANY  
MEDIUM  
SINGLE POST  
ON A  
STANDARD  
3 PIECE  
POST**

**E27**  
FRAME SIZE  
H - 236cm  
W - 30cm

**\* NOTE \***  
*Single  
Post  
Is  
Supplied  
With  
A  
Total  
3  
Pieces  
+  
Post Top  
-*



**- NOTE -**  
*Chain  
Pendant  
Is For  
Interior  
Use  
Only  
-  
Supplied  
With A  
1MT  
Chain*

1000026

**ALBANY  
MEDIUM  
CHAIN PND**

**E27**  
FRAME SIZE -  
H - 60cm W - 30cm

**IP - 44  
Rated**



**- NOTE -**  
*Rod  
Pendant  
Is For  
Exterior  
Use*

H - 5cm  
H - 20cm  
H - 20cm  
H - 20cm  
H - 20cm

1000027

**ALBANY  
MEDIUM  
ROD PND**

**E27**  
FRAME SIZE  
H - 60cm W - 30cm  
+ 4 x 20cm RODS  
+ 1 x 5cm CAP



1000155

**ALBANY  
MEDIUM  
ON  
DOMAIN  
POST**

**E27**  
FRAME SIZE  
H - 278cm W - 30cm

**\* NOTE \***  
*If A  
Higher  
Post  
Height  
Is  
Required  
Please  
Use  
This  
Domain  
Post.  
Heavy  
Duty Thick  
Casting  
With  
4 Hole  
Floor  
Mounting*

**- Warranty Conditions -**

Any claim must be made within 12 Months from the date of purchase.  
To make a claim, take the product with a Receipt of proof of purchase to retailer.

**- Warranty Exclusions -**

1 - Fading due to weather exposure. 2 - Installation within 2km of salt water spray.  
3 - Damage to product through accident, misuse or negligence.



**- Exterior Range -**



**1000031**

**ALBANY MEDIUM W/B**

**E27**

**FRAME SIZE**

H - 70cm W - 30cm P - 38cm



**1000033**

**ALBANY SMALL W/B**

**E27**

**FRAME SIZE**

H - 53cm W - 22cm P - 28cm



**1000032**

**ALBANY MINI W/B**

**E27**

**FRAME SIZE**

H - 47cm W - 17cm P - 22cm



**1000029**

**ALBANY  
SMALL PILLAR MOUNT**

**E27**

**FRAME SIZE -**

H - 60cm W - 22cm

***Antique  
Bronze***

***IP - 44  
Rated***



**1000028**

**ALBANY  
MEDIUM PILLAR MOUNT**

**E27**

**FRAME SIZE -**

H - 71cm W - 30cm

**- Warranty Conditions -**

*Any claim must be made within 12 Months from the date of purchase.  
To make a claim, take the product with a Receipt of proof of purchase to retailer.*

**- Warranty Exclusions -**

*1 - Fading due to weather exposure. 2 - Installation within 2km of salt water spray.  
3 - Damage to product through accident, misuse or negligence.*

**- Exterior Range -**

**Flinders  
Antique Bronze  
Range**



**1000196**  
**FLINDERS  
LARGE  
SINGLE  
POST  
ON A  
STANDARD  
3 PIECE  
POST  
E27**  
**FRAME SIZE**  
H - 242cm  
W - 30cm

**\* NOTE \***  
*Single  
Post  
Is  
Supplied  
With  
A  
Total  
3  
Pieces  
+  
Post Top  
-*



**- NOTE -**  
*Chain  
Pendant  
Is For  
Interior  
Use  
Only*  
-  
*Supplied  
With A  
1MT  
Chain*

**1000188**  
**FLINDERS  
LARGE  
CHAIN PND  
E27**  
**FRAME SIZE -**  
H - 65cm W - 30cm

**IP - 12  
Rated**



**- NOTE -**  
*Rod  
Pendant  
Is For  
Exterior  
Use*

**1000190**  
**FLINDERS  
LARGE  
ROD PND  
E27**  
**FRAME SIZE**  
H - 68cm W - 30cm  
+ 4 x 20cm RODS  
+ 1 x 5cm CAP



**1000153**  
**FLINDERS  
LARGE  
ON  
DOMAIN  
POST  
E27**  
**FRAME SIZE**  
H - 278cm  
W - 30cm

**\* NOTE \***  
*If A  
Higher  
Post  
Height  
Is  
Required  
Please  
Use  
This  
Domain  
Post.  
Heavy  
Duty Thick  
Casting  
With  
4 Hole  
Floor  
Mounting*

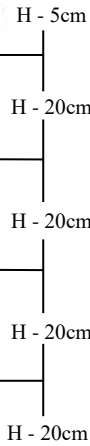

**- Warranty Conditions -**

Any claim must be made within 12 Months from the date of purchase.  
To make a claim, take the product with a Receipt of proof of purchase to retailer.

**- Warranty Exclusions -**

1 - Fading due to weather exposure. 2 - Installation within 2km of salt water spray.  
3 - Damage to product through accident, misuse or negligence.

**- Exterior Range -**



1000204

**FLINDERS  
LARGE W/B**  
E27  
FRAME SIZE  
H - 78cm W - 30cm  
P - 41cm



1000206

**FLINDERS  
MEDIUM W/B**  
E27  
FRAME SIZE  
H - 58cm W - 20cm  
P - 30cm



1000212

**FLINDERS  
SMALL W/B**  
E27  
FRAME SIZE  
H - 52cm W - 16cm  
P - 26cm

**IP - 12  
Rated**

**Antique  
Bronze**



1000200

**FLINDERS  
SMALL  
UNDER EAVE**  
E27  
FRAME SIZE -  
H - 44cm W - 16cm



1000198

**FLINDERS  
MEDIUM  
UNDER EAVE**  
E27  
FRAME SIZE -  
H - 50cm W - 20cm



1000192

**FLINDERS  
LARGE  
PILLAR MOUNT**  
E27  
FRAME SIZE -  
H - 79cm W - 30cm



1000194

**FLINDERS  
MEDIUM  
PILLAR MOUNT**  
E27  
FRAME SIZE -  
H - 64cm W - 20cm

**- Warranty Conditions -**  
Any claim must be made within 12 Months from the date of purchase.  
To make a claim, take the product with a Receipt of proof of purchase to retailer.

**- Warranty Exclusions -**  
1 - Fading due to weather exposure. 2 - Installation within 2km of salt water spray.  
3 - Damage to product through accident, misuse or negligence.

**- Exterior Range -**

**Flinders  
Antique Black  
Range**

**Antique  
Black**



**1000195**

**FLINDERS  
LARGE  
SINGLE  
POST  
ON A  
STANDARD  
3 PIECE  
POST**

**E27  
FRAME SIZE  
H - 242cm  
W - 30cm**

**\* NOTE \***  
Single Post Is Supplied With A Total 3 Pieces + Post Top -



**1000187**

**FLINDERS  
LARGE  
CHAIN PND**

**E27  
FRAME SIZE -  
H - 65cm W - 30cm**

**- NOTE -  
Chain  
Pendant  
Is For  
Interior  
Use  
Only  
-  
Supplied  
With A  
1 MT  
Chain**

**IP - 12  
Rated**

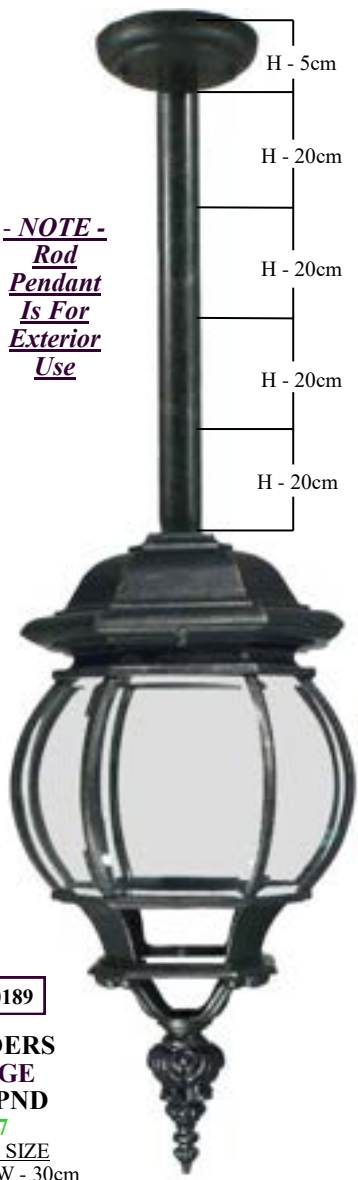

**1000189**

**FLINDERS  
LARGE  
ROD PND**

**E27  
FRAME SIZE  
H - 68cm W - 30cm  
+ 4 x 20cm RODS  
+ 1 x 5cm CAP**

**- NOTE -  
Rod  
Pendant  
Is For  
Exterior  
Use**



**1000154**

**FLINDERS  
LARGE  
ON  
DOMAIN  
POST**

**E27  
FRAME SIZE  
H - 278cm  
W - 30cm**

**\* NOTE \***  
If A Higher Post Height Is Required Please Use This Domain Post. Heavy Duty Thick Casting With 4 Hole Floor Mounting

**- Warranty Conditions -**

Any claim must be made within 12 Months from the date of purchase. To make a claim, take the product with a Receipt of proof of purchase to retailer.

**- Warranty Exclusions -**

1 - Fading due to weather exposure. 2 - Installation within 2km of salt water spray. 3 - Damage to product through accident, misuse or negligence.

**- Exterior Range -**



**1000203**

**FLINDERS  
LARGE W/B**

**E27**

**FRAME SIZE**

H - 78cm W - 30cm  
P - 41cm



**1000205**

**FLINDERS  
MEDIUM W/B**

**E27**

**FRAME SIZE**

H - 58cm W - 20cm  
P - 30cm



**1000211**

**FLINDERS  
SMALL W/B**

**E27**

**FRAME SIZE**

H - 52cm W - 16cm  
P - 26cm

*Antique  
Black*

*IP - 12  
Rated*



**1000199**

**FLINDERS  
SMALL  
UNDER EAVE**

**E27**

**FRAME SIZE -**

H - 44cm W - 16cm



**1000197**

**FLINDERS  
MEDIUM  
UNDER EAVE**

**E27**

**FRAME SIZE -**

H - 50cm W - 20cm



**1000191**

**FLINDERS  
LARGE  
PILLAR MOUNT**

**E27**

**FRAME SIZE -**

H - 79cm W - 30cm



**1000193**

**FLINDERS  
MEDIUM  
PILLAR MOUNT**

**E27**

**FRAME SIZE -**

H - 64cm W - 20cm

**- Warranty Conditions -**  
Any claim must be made within 12 Months from the date of purchase.  
To make a claim, take the product with a Receipt of proof of purchase to retailer.

**- Warranty Exclusions -**  
1 - Fading due to weather exposure. 2 - Installation within 2km of salt water spray.  
3 - Damage to product through accident, misuse or negligence.

**- Exterior Range -**

**Waterford  
Range**



**1000565**

**WATERFORD  
LARGE  
SINGLE POST  
ON A  
STANDARD  
3 PIECE POST**

**E27**  
FRAME SIZE  
H - 236cm  
W - 38cm

**\* NOTE \***  
Single Post Is Supplied With A Total 3 Pieces + Post Top -



**1000561**

**WATERFORD  
LARGE  
CHAIN PND**

**E27**  
FRAME SIZE -  
H - 62cm W - 38cm

**IP - 44  
Rated**

**- NOTE -**  
Chain Pendant Is For Interior Use Only - Supplied With A 1 MT Chain

**Antique  
Black**

**1000158**

**WATERFORD  
LARGE  
ON  
DOMAIN  
POST**

**E27**  
FRAME SIZE  
H - 281cm  
W - 36cm

**\* NOTE \***  
If A Higher Post Height Is Required Please Use This Domain Post. Heavy Duty Thick Casting With 4 Hole Floor Mounting

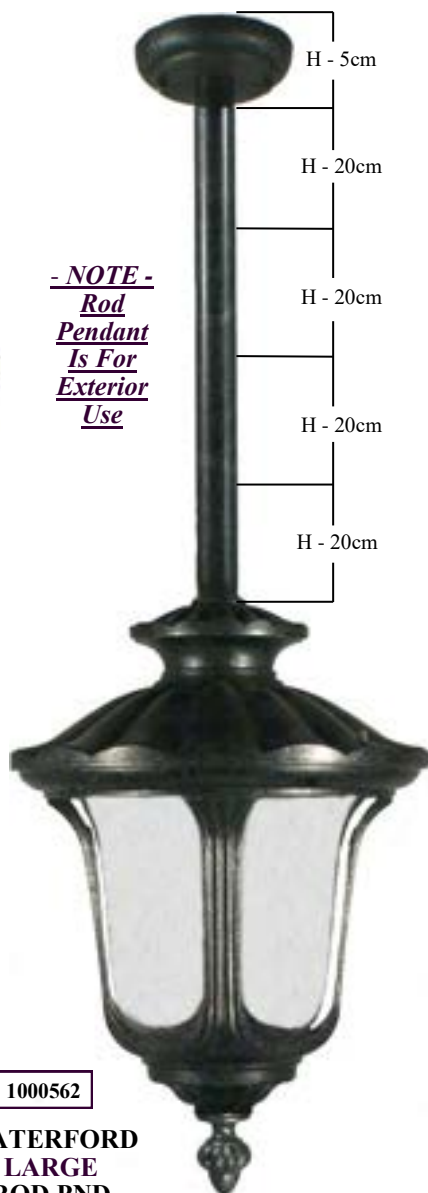

**- NOTE -**  
Rod Pendant Is For Exterior Use

H - 5cm  
H - 20cm  
H - 20cm  
H - 20cm  
H - 20cm

**1000562**

**WATERFORD  
LARGE  
ROD PND**

**E27**  
FRAME SIZE  
H - 58cm W - 38cm  
+ 4 x 20cm RODS  
+ 1 x 5cm CAP



**- Warranty Conditions -**

Any claim must be made within 12 Months from the date of purchase. To make a claim, take the product with a Receipt of proof of purchase to retailer.

**- Warranty Exclusions -**

1 - Fading due to weather exposure. 2 - Installation within 2km of salt water spray. 3 - Damage to product through accident, misuse or negligence.

**- Exterior Range -**



**1000569**  
**WATERFORD  
 LARGE W/B**  
 E27  
 FRAME SIZE  
 H - 70cm W - 36cm  
 P - 42cm



**1000571**  
**WATERFORD  
 MEDIUM W/B**  
 E27  
 FRAME SIZE  
 H - 54cm W - 28cm  
 P - 33cm



**1000573**  
**WATERFORD  
 SMALL W/B**  
 E27  
 FRAME SIZE  
 H - 45cm W - 23cm  
 P - 28cm

**IP - 44  
 Rated**

***Antique  
 Black***



**1000567**  
**WATERFORD  
 SMALL  
 UNDER EAVE**  
 E27  
 FRAME SIZE -  
 H - 41cm W - 23cm



**1000566**  
**WATERFORD  
 MEDIUM  
 UNDER EAVE**  
 E27  
 FRAME SIZE -  
 H - 51cm W - 28cm



**1000563**  
**WATERFORD  
 LARGE  
 PILLAR MOUNT**  
 E27  
 FRAME SIZE -  
 H - 78cm W - 36cm



**1000564**  
**WATERFORD  
 MEDIUM  
 PILLAR MOUNT**  
 E27  
 FRAME SIZE -  
 H - 65cm W - 28cm

***- Warranty Conditions -***

*Any claim must be made within 12 Months from the date of purchase.  
 To make a claim, take the product with a Receipt of proof of purchase to retailer.*

***- Warranty Exclusions -***

*1 - Fading due to weather exposure. 2 - Installation within 2km of salt water spray.  
 3 - Damage to product through accident, misuse or negligence.*

**- Exterior Range -**

**Wellington  
Range**

**Antique  
Black**



**1000578**

**WELLINGTON  
LARGE  
SINGLE POST  
ON A  
STANDARD  
3 PIECE  
POST**

**E27**

**FRAME SIZE**

H - 226cm

W - 28cm

**\* NOTE \***  
*Single  
Post  
Is  
Supplied  
With  
A  
Total  
3  
Pieces  
+  
Post Top  
-*



**1000574**

**WELLINGTON  
LARGE  
CHAIN PND**

**E27**

**FRAME SIZE -**

H - 52cm W - 29cm

**- NOTE -**  
*Chain  
Pendant  
Is For  
Interior  
Use  
Only*

**-  
Supplied  
With A  
1 MT  
Chain**

**- NOTE -**  
*Rod  
Pendant  
Is For  
Exterior  
Use*

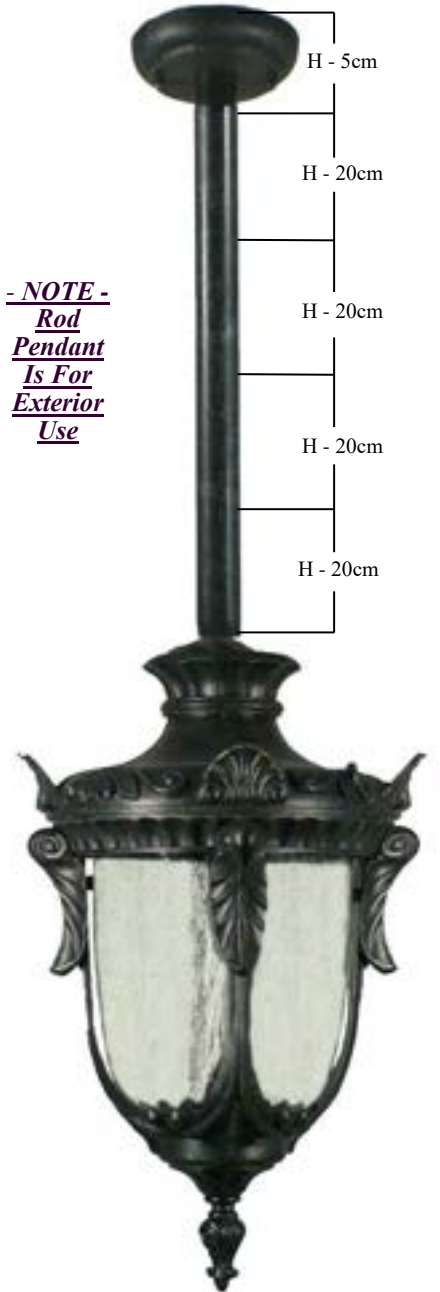

**1000575**

**WELLINGTON  
LARGE  
ROD PND**

**E27**

**FRAME SIZE**

H - 48cm

W - 29cm

+ 4 x 20cm RODS

+ 1 x 5cm CAP

**IP - 44  
Rated**

**- Warranty Conditions -**

Any claim must be made within 12 Months from the date of purchase.  
To make a claim, take the product with a Receipt of proof of purchase to retailer.

**- Warranty Exclusions -**

1 - Fading due to weather exposure. 2 - Installation within 2km of salt water spray.  
3 - Damage to product through accident, misuse or negligence.



**- Exterior Range -**



1000582

**WELLINGTON  
LARGE W/B**

E27

FRAME SIZE  
H - 64cm W - 25cm  
P - 32cm

**IP - 44  
Rated**



1000584

**WELLINGTON  
MEDIUM W/B**

E27

FRAME SIZE  
H - 53cm W - 20cm  
P - 26cm



1000586

**WELLINGTON  
SMALL W/B**

E27

FRAME SIZE  
H - 43cm W - 15cm  
P - 24cm

***Antique  
Black***



1000580

**WELLINGTON  
SMALL  
UNDER EAVE**

E27

FRAME SIZE -  
H - 36cm W - 15cm



1000579

**WELLINGTON  
MEDIUM  
UNDER EAVE**

E27

FRAME SIZE -  
H - 45cm W - 20cm



1000576

**WELLINGTON  
LARGE  
PILLAR MOUNT**

E27

FRAME SIZE -  
H - 68cm W - 29cm



1000577

**WELLINGTON  
MEDIUM  
PILLAR MOUNT**

E27

FRAME SIZE -  
H - 60cm W - 20cm

**- Warranty Conditions -**

*Any claim must be made within 12 Months from the date of purchase.  
To make a claim, take the product with a Receipt of proof of purchase to retailer.*

**- Warranty Exclusions -**

*1 - Fading due to weather exposure. 2 - Installation within 2km of salt water spray.  
3 - Damage to product through accident, misuse or negligence.*

**- Exterior Range -**

**Strand  
Range**

**Antique  
Bronze**

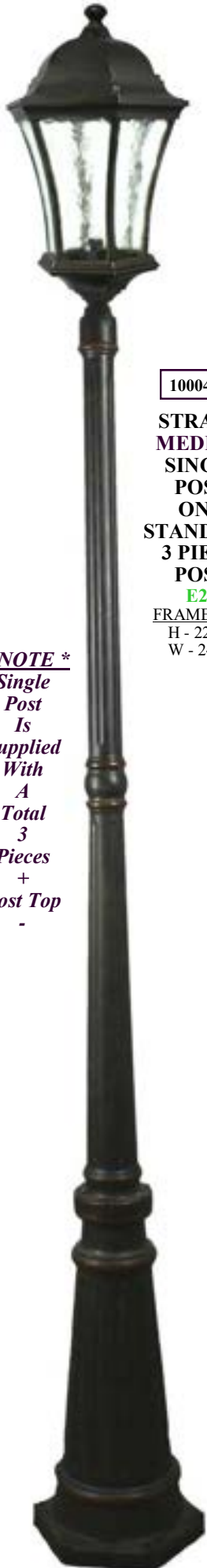

**1000494**  
**STRAND  
 MEDIUM  
 SINGLE  
 POST  
 ON A  
 STANDARD  
 3 PIECE  
 POST**  
 E27  
 FRAME SIZE  
 H - 223cm  
 W - 24cm

**\* NOTE \***  
 Single  
 Post  
 Is  
 Supplied  
 With  
 A  
 Total  
 3  
 Pieces  
 +  
 Post Top  
 -



**- NOTE -**  
Chain  
Pendant  
Is For  
Interior  
Use  
Only  
 -  
Supplied  
With A  
1MT  
Chain

**1000490**  
**STRAND  
 MEDIUM  
 CHAIN PND**  
 E27  
 FRAME SIZE -  
 H - 43cm W - 24cm



**- NOTE -**  
Rod  
Pendant  
Is For  
Exterior  
Use

**1000491**  
**STRAND  
 MEDIUM  
 ROD PND**  
 E27  
 FRAME SIZE  
 H - 39cm  
 W - 24cm  
 + 4 x 20cm RODS  
 + 1 x 5cm CAP

**IP - 44  
 Rated**

**- Warranty Conditions -**

Any claim must be made within 12 Months from the date of purchase.  
 To make a claim, take the product with a Receipt of proof of purchase to retailer.

**- Warranty Exclusions -**

1 - Fading due to weather exposure. 2 - Installation within 2km of salt water spray.  
 3 - Damage to product through accident, misuse or negligence.

**- Exterior Range -**



**1000497**  
**STRAND**  
**MEDIUM W/B**  
**E27**  
**FRAME SIZE**  
 H - 50cm W - 24cm  
 P - 30cm



**1000499**  
**STRAND**  
**SMALL W/B**  
**E27**  
**FRAME SIZE**  
 H - 41cm W - 21cm  
 P - 23cm

***Antique  
Bronze***



**1000496**  
**STRAND**  
**SMALL**  
**UNDER EAVE**  
**E27**  
**FRAME SIZE -**  
 H - 35cm W - 21cm



**1000495**  
**STRAND**  
**MEDIUM**  
**UNDER EAVE**  
**E27**  
**FRAME SIZE -**  
 H - 42cm W - 24cm



**1000493**  
**STRAND**  
**SMALL**  
**PILLAR MOUNT**  
**E27**  
**FRAME SIZE -**  
 H - 53cm W - 21cm



**1000492**  
**STRAND**  
**MEDIUM**  
**PILLAR MOUNT**  
**E27**  
**FRAME SIZE -**  
 H - 60cm W - 24cm

***IP - 44  
Rated***

**- Warranty Conditions -**

*Any claim must be made within 12 Months from the date of purchase. To make a claim, take the product with a Receipt of proof of purchase to retailer.*

**- Warranty Exclusions -**

*1 - Fading due to weather exposure. 2 - Installation within 2km of salt water spray. 3 - Damage to product through accident, misuse or negligence.*

**- Exterior Range -**

**Tilburn  
Range**

**Antique  
Bronze**



**1000819**

**TILBURN  
LARGE  
SINGLE POST  
ON A  
STANDARD  
3 PIECE  
POST**

**E27**  
FRAME SIZE  
H - 223cm  
W - 23cm

**\* NOTE \***  
*Single  
Post  
Is  
Supplied  
With  
A  
Total  
3  
Pieces  
+  
Post Top  
-*



**- NOTE -**  
*Chain  
Pendant  
Is For  
Interior  
Use  
Only  
-  
Supplied  
With A  
1 MT  
Chain*

**1000818**

**TILBURN  
LARGE  
CHAIN PND**

**E27**  
FRAME SIZE -  
H - 47cm W - 23cm

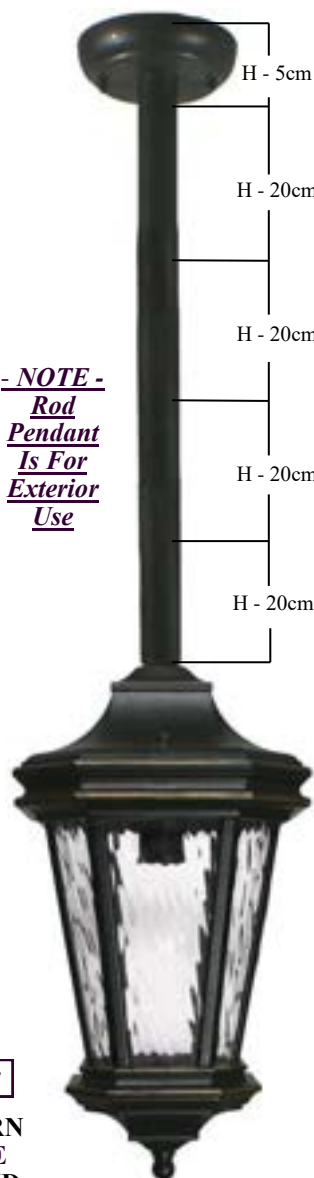

**- NOTE -**  
*Rod  
Pendant  
Is For  
Exterior  
Use*

**1000817**

**TILBURN  
LARGE  
ROD PND**

**E27**  
FRAME SIZE  
H - 43cm W - 23cm  
+ 4 x 20cm RODS  
+ 1 x 5cm CAP



**1000157**

**TILBURN  
LARGE  
ON  
DOMAIN  
POST**

**E27**  
FRAME SIZE  
H - 269cm W - 23cm

**\* NOTE \***  
*If A  
Higher  
Post  
Height  
Is  
Required  
Please  
Use  
This  
Domain  
Post.  
Heavy  
Duty Thick  
Casting  
With  
4 Hole  
Floor  
Mounting*

**IP - 44  
Rated**

**- Warranty Conditions -**

Any claim must be made within 12 Months from the date of purchase.  
To make a claim, take the product with a Receipt of proof of purchase to retailer.

**- Warranty Exclusions -**

1 - Fading due to weather exposure. 2 - Installation within 2km of salt water spray.  
3 - Damage to product through accident, misuse or negligence.

**- Exterior Range -**



1000813

**TILBURN  
LARGE W/B**  
E27  
FRAME SIZE  
H - 54cm W - 23cm  
P - 32cm



1000814

**TILBURN  
MEDIUM W/B**  
E27  
FRAME SIZE  
H - 37cm W - 17cm  
P - 23cm

*Antique  
Bronze*



1000816

**TILBURN  
LARGE  
UNDER EAVE**  
E27  
FRAME SIZE -  
H - 45cm W - 23cm

*IP - 44  
Rated*



1000815

**TILBURN  
LARGE  
PILLAR MOUNT**  
E27  
FRAME SIZE  
H - 64cm W - 23cm

**- Warranty Conditions -**

Any claim must be made within 12 Months from the date of purchase.  
To make a claim, take the product with a Receipt of proof of purchase to retailer.

74

**- Warranty Exclusions -**

1 - Fading due to weather exposure. 2 - Installation within 2km of salt water spray.  
3 - Damage to product through accident, misuse or negligence.

**- Exterior Range -**

**Mayfair  
Range**

**Antique  
Bronze**



**1000315**  
MAYFAIR  
SINGLE POST  
ON A  
STANDARD  
3 PIECE  
POST  
E27  
FRAME SIZE  
H - 228cm W - 26cm

**\* NOTE \***  
Single  
Post  
Is  
Supplied  
With  
A  
Total  
3  
Pieces  
+  
Post Top  
-



**1000312**  
MAYFAIR  
CHAIN PND  
E27  
FRAME SIZE -  
H - 49cm W - 26cm

**- NOTE -**  
Chain  
Pendant  
Is For  
Interior  
Use  
Only  
-  
Supplied  
With A  
1 MT  
Chain

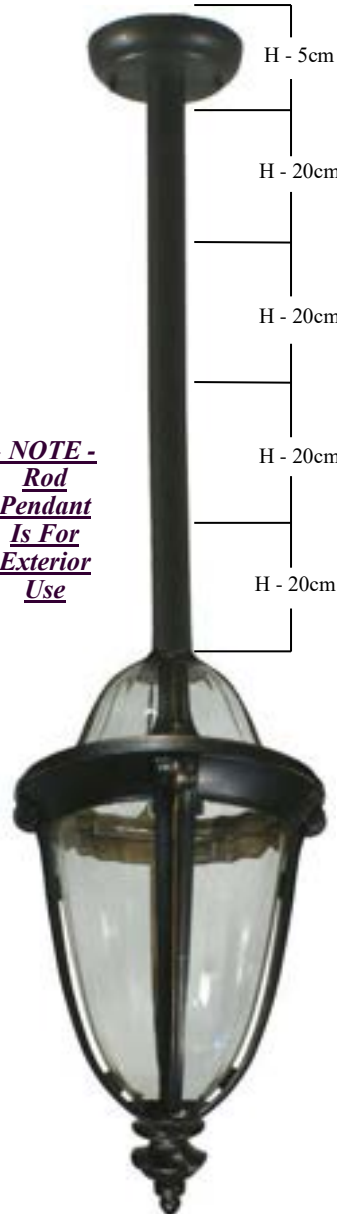

**1000313**  
MAYFAIR ROD PND  
E27  
FRAME SIZE  
H - 49cm W - 26cm  
+ 4 x 20cm RODS  
+ 1 x 5cm CAP

**- NOTE -**  
Rod  
Pendant  
Is For  
Exterior  
Use

**1000150**  
MAYFAIR  
ON  
DOMAIN  
POST  
E27  
FRAME SIZE  
H - 269cm W - 26cm

**\* NOTE \***  
If A  
Higher  
Post  
Height  
Is  
Required  
Please  
Use  
This  
Domain  
Post.  
Heavy  
Duty Thick  
Casting  
With  
4 Hole  
Floor  
Mounting

**IP - 44  
Rated**

**- Warranty Conditions -**

Any claim must be made within 12 Months from the date of purchase.  
To make a claim, take the product with a Receipt of proof of purchase to retailer.

**- Warranty Exclusions -**

1 - Fading due to weather exposure. 2 - Installation within 2km of salt water spray.  
3 - Damage to product through accident, misuse or negligence.

**- Exterior Range -**

***Antique  
Bronze***



***IP - 44  
Rated***

1000317

**MAYFAIR  
W/B  
E27**

**FRAME SIZE**  
H - 57cm W - 26cm  
P - 31cm



1000316

**MAYFAIR  
UNDER EAVE  
E27**

**FRAME SIZE**  
H - 54cm W - 26cm

***\*Features\*  
One Piece  
Oval  
Glassware***



1000314

**MAYFAIR  
PILLAR MOUNT  
E27**

**FRAME SIZE**  
H - 69cm W - 26cm

***- Warranty Conditions -***

*Any claim must be made within 12 Months from the date of purchase.  
To make a claim, take the product with a Receipt of proof of purchase to retailer.*

**76**

***- Warranty Exclusions -***

*1 - Fading due to weather exposure. 2 - Installation within 2km of salt water spray.  
3 - Damage to product through accident, misuse or negligence.*

- Exterior Range -

**Argyle  
Range**

**Antique  
Black**

- NOTE -  
Rod  
Pendant  
Is For  
Exterior  
Use



1000044

**ARGYLE  
W/B  
E27**

FRAME SIZE  
H - 31cm W - 17cm  
P - 22cm

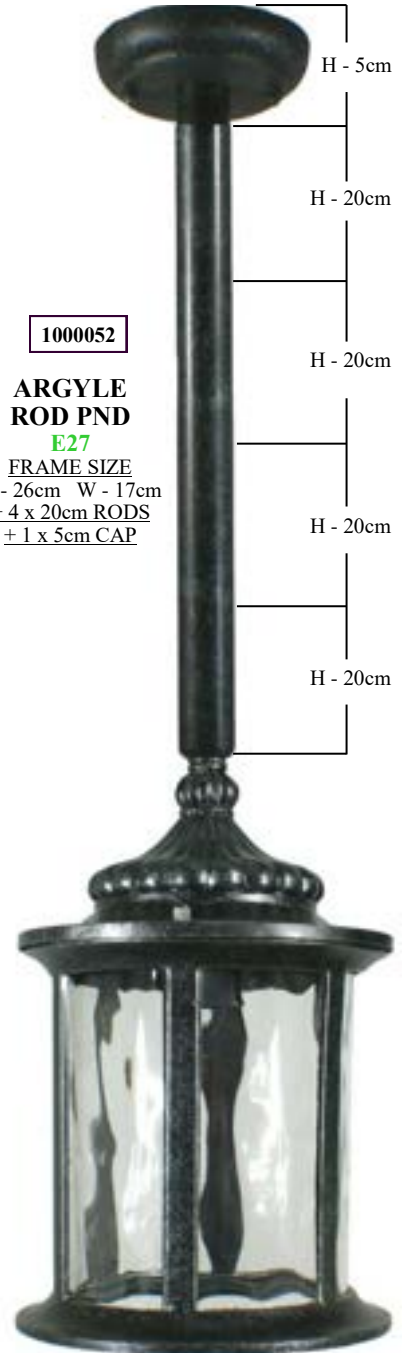

1000052

**ARGYLE  
ROD PND**

**E27**  
FRAME SIZE  
H - 26cm W - 17cm  
+ 4 x 20cm RODS  
+ 1 x 5cm CAP

H - 5cm

H - 20cm

H - 20cm

H - 20cm

H - 20cm

**IP - 03  
Rated**



1000043

**ARGYLE  
UNDER EAVE  
E27**

FRAME SIZE  
H - 30cm W - 17cm

- Warranty Conditions -

Any claim must be made within 12 Months from the date of purchase.  
To make a claim, take the product with a Receipt of proof of purchase to retailer.

- Warranty Exclusions -

1 - Fading due to weather exposure. 2 - Installation within 2km of salt water spray.  
3 - Damage to product through accident, misuse or negligence.



**- Exterior Range -**

**Station  
Range**

**- NOTE -**  
**Rod**  
**Pendant**  
**Is For**  
**Exterior**  
**Use**

**Antique  
Black**

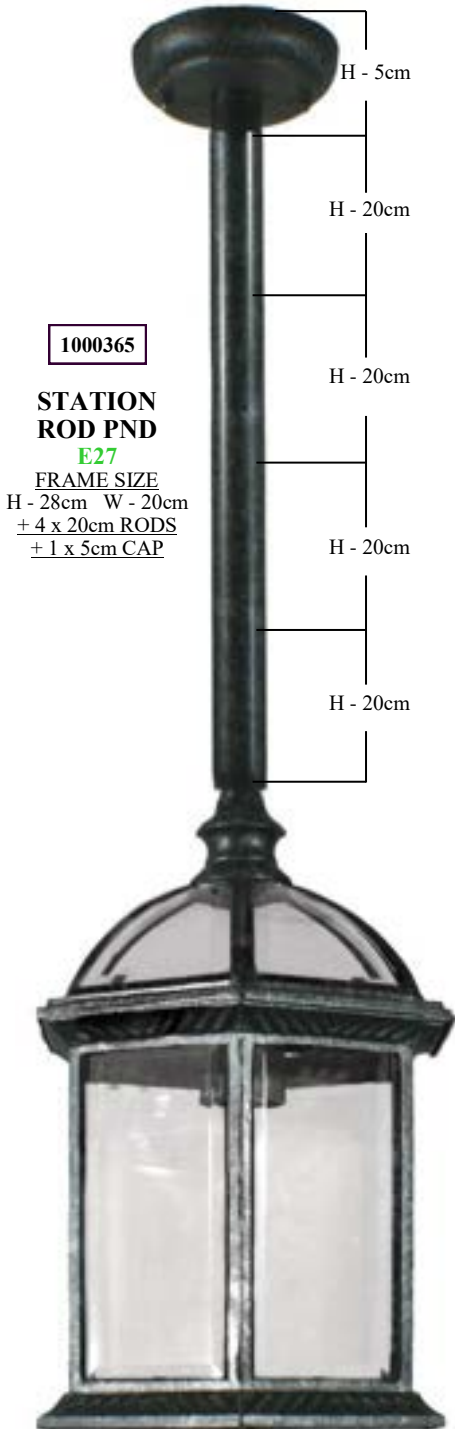

**1000365**

**STATION  
ROD PND**  
**E27**  
**FRAME SIZE**  
H - 28cm W - 20cm  
+ 4 x 20cm RODS  
+ 1 x 5cm CAP



**1000464**

**STATION W/B**  
**E27**  
**FRAME SIZE**  
H - 41cm W - 20cm  
P - 20cm



**1000363**

**STATION  
UNDER EAVE**  
**E27**  
**FRAME SIZE**  
H - 31cm W - 20cm

**IP - 03  
Rated**

**- Warranty Conditions -**

Any claim must be made within 12 Months from the date of purchase.  
To make a claim, take the product with a Receipt of proof of purchase to retailer.

**- Warranty Exclusions -**

1 - Fading due to weather exposure. 2 - Installation within 2km of salt water spray.  
3 - Damage to product through accident, misuse or negligence.

**- Exterior Range -**

**Urban  
Range**

**Antique  
Bronze**

**1000529**

**URBAN  
W/B  
E27**

FRAME SIZE  
H - 26cm W - 25cm  
P - 43cm

**Globes  
Not Supplied**



**- NOTE -  
Rod  
Pendant  
Is For  
Exterior  
Use**

**- NOTE -  
Chain  
Pendant  
Is For  
Interior  
Use  
Only  
-  
Supplied  
With A  
1 MT  
Chain**

**1000527**

**URBAN  
UNDER EAVE  
E27**

FRAME SIZE -  
H - 20cm W - 25cm



**Globes  
Not Supplied**

**1000526**

**URBAN  
ROD PND  
E27**

FRAME SIZE  
H - 16cm W - 25cm  
+ 4 x 20cm RODS  
+ 1 x 5cm CAP

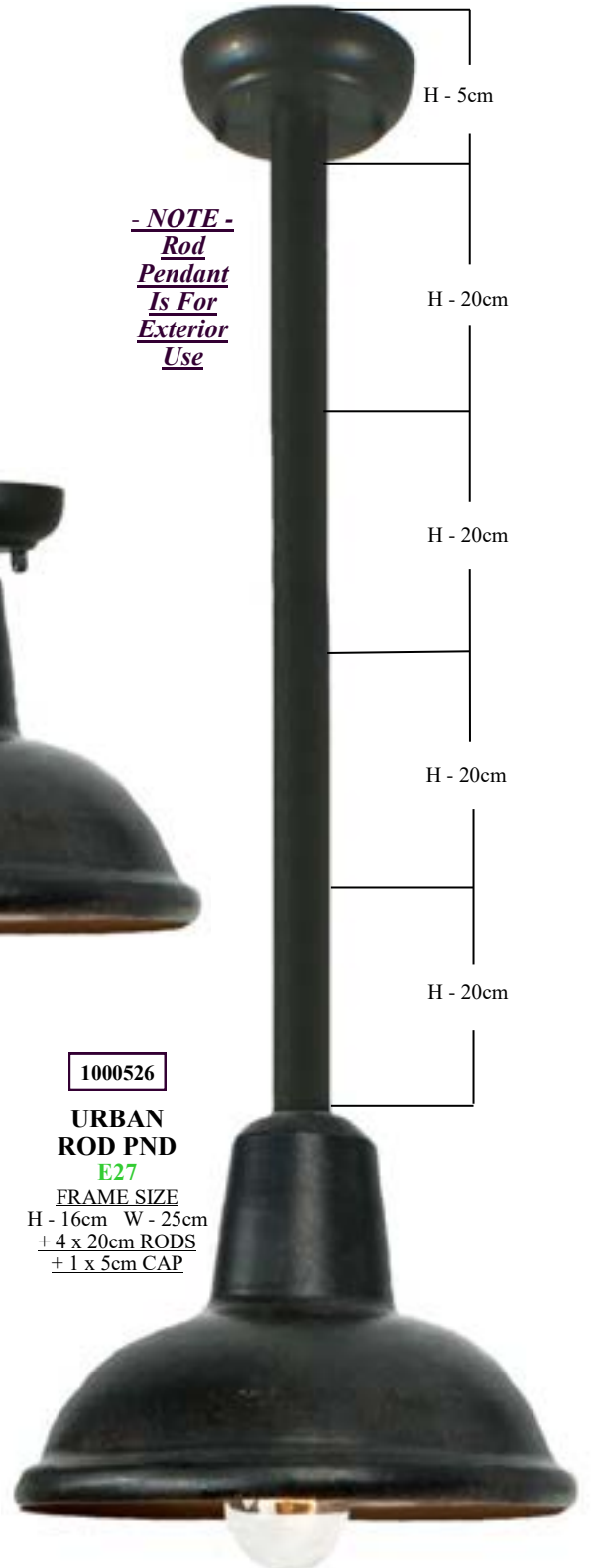

**1000528**

**URBAN  
CHAIN PND  
E27**

FRAME SIZE  
H - 16cm W - 25cm



**IP - 03  
Rated**

**- Warranty Conditions -**

Any claim must be made within 12 Months from the date of purchase.  
To make a claim, take the product with a Receipt of proof of purchase to retailer.

**- Warranty Exclusions -**

1 - Fading due to weather exposure. 2 - Installation within 2km of salt water spray.  
3 - Damage to product through accident, misuse or negligence.

**- Exterior Range -**

***Terminal  
Range***

**1000514**

**TERMINAL  
W/B**

**E27**

**FRAME SIZE**

H - 26cm W - 21cm

P - 25cm



***Antique  
Bronze***

**- NOTE -**  
**Rod**  
**Pendant**  
**Is For**  
**Exterior**  
**Use**

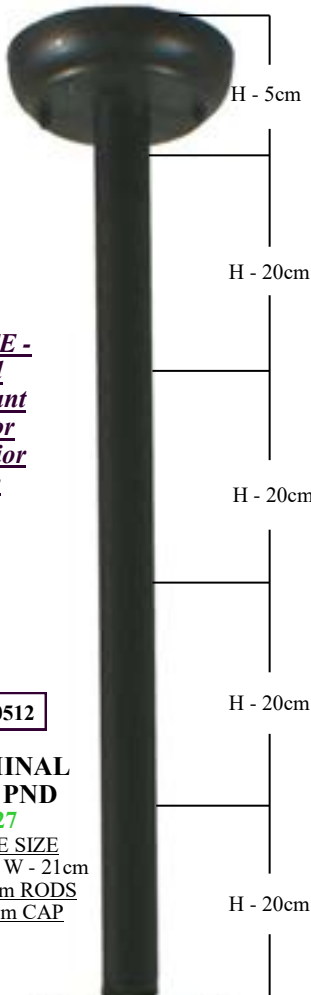

**1000512**

**TERMINAL  
ROD PND**

**E27**

**FRAME SIZE**

H - 19cm W - 21cm

+ 4 x 20cm RODS

+ 1 x 5cm CAP



**1000513**

**TERMINAL  
UNDER EAVE**

**E27**

**FRAME SIZE -**

H - 23cm W - 21cm

**- NOTE -**  
**Chain**  
**Pendant**  
**Is For**  
**Interior**  
**Use**  
**Only**  
**-**  
**Supplied**  
**With A**  
**1 MT**  
**Chain**



**1000510**

**TERMINAL  
CHAIN PND**

**E27**

**FRAME SIZE**

H - 19cm W - 21cm

***IP - 03  
Rated***

**- Warranty Conditions -**

Any claim must be made within 12 Months from the date of purchase.  
To make a claim, take the product with a Receipt of proof of purchase to retailer.

**- Warranty Exclusions -**

1 - Fading due to weather exposure. 2 - Installation within 2km of salt water spray.  
3 - Damage to product through accident, misuse or negligence.

**- Exterior Range -**

**Port  
Range**

***Antique  
Bronze***



**1000400**

**PORT  
W/B  
E27**  
FRAME SIZE  
H - 33cm W - 22cm  
P - 30cm

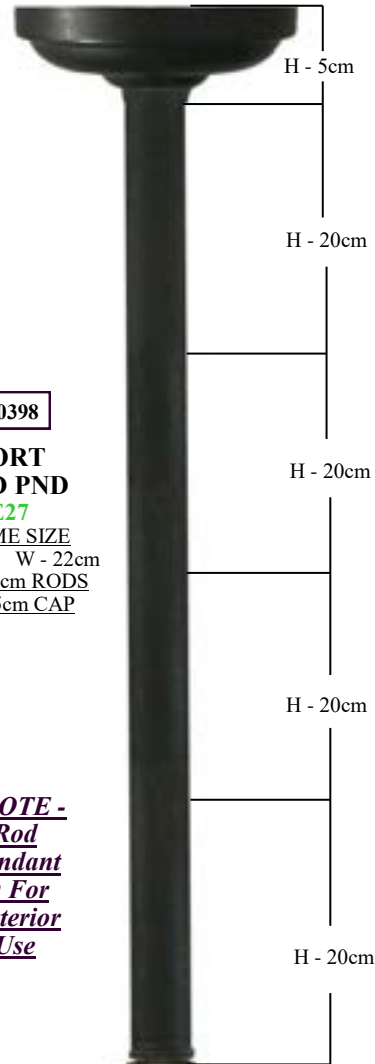

**1000398**

**PORT  
ROD PND  
E27**  
FRAME SIZE  
H - 25cm W - 22cm  
+ 4 x 20cm RODS  
+ 1 x 5cm CAP

***Globes  
Not Supplied***



**1000399**

**PORT  
UNDER EAVE  
E27**  
FRAME SIZE -  
H - 29cm W - 22cm

***- NOTE -  
Rod  
Pendant  
Is For  
Exterior  
Use***

***- NOTE -  
Chain  
Pendant  
Is For  
Interior  
Use  
Only  
-  
Supplied  
With A  
1 MT  
Chain***

**1001400**

**PORT  
CHAIN PND  
E27**  
FRAME SIZE  
H - 25cm W - 22cm



***IP - 44  
Rated***

**- Warranty Conditions -**

Any claim must be made within 12 Months from the date of purchase.  
To make a claim, take the product with a Receipt of proof of purchase to retailer.

**- Warranty Exclusions -**

1 - Fading due to weather exposure. 2 - Installation within 2km of salt water spray.  
3 - Damage to product through accident, misuse or negligence.

**- Exterior Range -**

**Dockyard  
Range**

**1000149**

**DOCKYARD  
W/B**  
E27  
FRAME SIZE  
H - 32cm W - 18cm  
P - 21cm



***Antique  
Bronze***

***Globes  
Not Supplied***

***- NOTE -  
Chain  
Pendant  
Is For  
Interior  
Use  
Only  
-  
Supplied  
With A  
1MT  
Chain***

**1001149**

**DOCKYARD  
CHAIN PND**  
E27  
FRAME SIZE  
H - 22cm  
W - 18cm

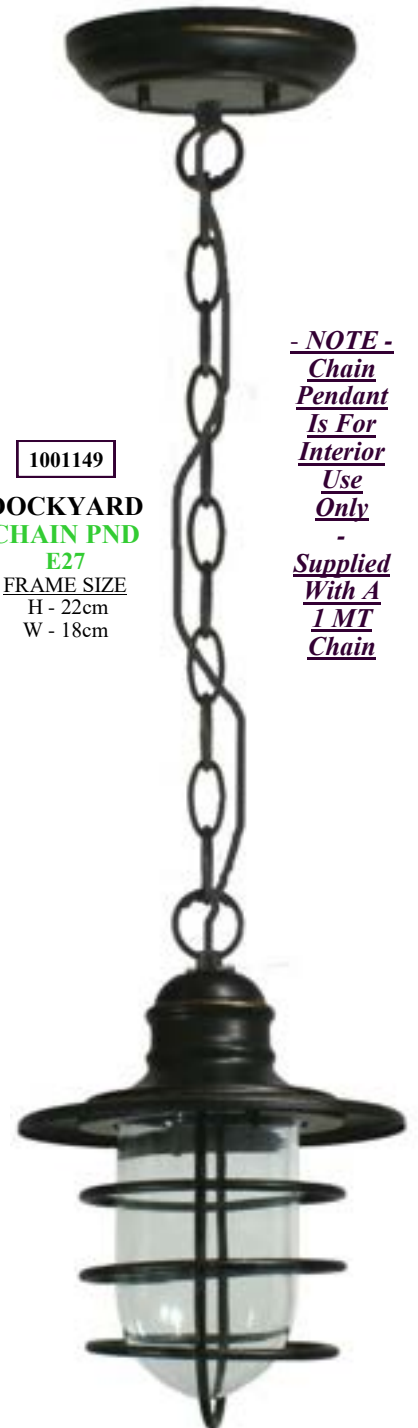

***- NOTE -  
Rod  
Pendant  
Is For  
Exterior  
Use***

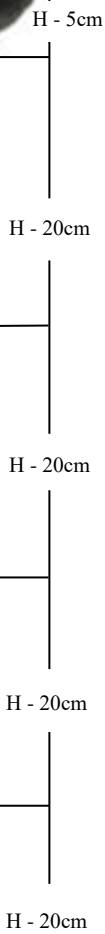

**1000147**

**DOCKYARD  
ROD PND**  
E27  
FRAME SIZE  
H - 22cm  
W - 18cm  
+ 4 x 20cm RODS  
+ 1 x 5cm CAP



**1000148**

**DOCKYARD  
UNDER EAVE**  
E27  
FRAME SIZE  
H - 24cm W - 18cm

***IP - 55  
Rated***

***- Warranty Conditions -***  
Any claim must be made within 12 Months from the date of purchase.  
To make a claim, take the product with a Receipt of proof of purchase to retailer.

***- Warranty Exclusions -***  
1 - Fading due to weather exposure. 2 - Installation within 2km of salt water spray.  
3 - Damage to product through accident, misuse or negligence.

**- Exterior Range -**

***Deckhouse Range***

***Screw In Glass Shade***

**1000146**

**DECKHOUSE  
W/B**

**E27**

**FRAME SIZE**

H - 42cm W - 35cm  
P - 59cm



***Antique  
Bronze***

**- NOTE -**  
**Chain**  
**Pendant**  
**Is For**  
**Interior**  
**Use**  
**Only**  
**-**  
**Supplied**  
**With A**  
**1 MT**  
**Chain**

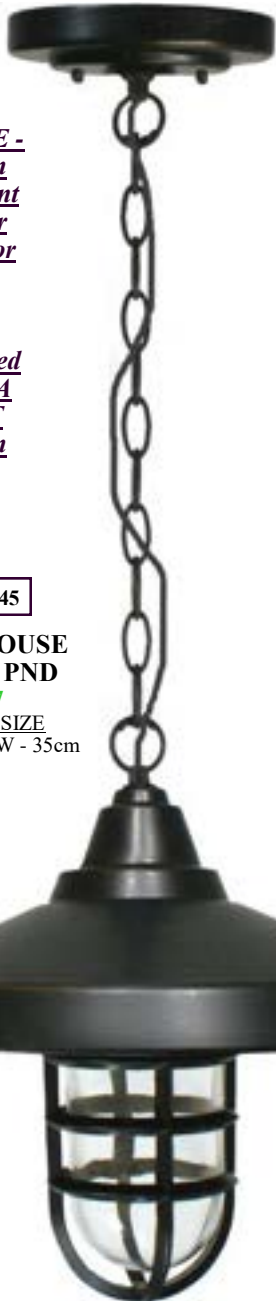

**1000145**

**DECKHOUSE  
CHAIN PND**

**E27**

**FRAME SIZE**

H - 29cm W - 35cm



**1000144**

**DECKHOUSE  
UNDER EAVE**

**E27**

**FRAME SIZE**

H - 32cm W - 35cm

***IP - 55  
Rated***



H - 5cm

H - 20cm

H - 20cm

H - 20cm

H - 20cm

**- NOTE -**  
**Rod**  
**Pendant**  
**Is For**  
**Exterior**  
**Use**

**1000143**

**DECKHOUSE  
ROD PND E27**

**FRAME SIZE**

H - 29cm W - 35cm

+ 4 x 20cm RODS

+ 1 x 5cm CAP

**- Warranty Conditions -**

Any claim must be made within 12 Months from the date of purchase.  
To make a claim, take the product with a Receipt of proof of purchase to retailer.

**- Warranty Exclusions -**

1 - Fading due to weather exposure. 2 - Installation within 2km of salt water spray.  
3 - Damage to product through accident, misuse or negligence.

- Exterior Range -

*Pier  
Range*

*IP - 55  
Rated*



1000397

PIER W/B

E27

FRAME

SIZE

H - 35cm W - 24cm  
P - 25cm

*Antique  
Bronze*

*IP - 44  
Rated*



1001221

GATEWAY W/B

E27

FRAME

SIZE

H - 28cm W - 12cm  
P - 19cm

*Gateway  
Range*



*IP - 55  
Rated*

1000596

WHARF W/B

E27

FRAME

SIZE

H - 32cm W - 14cm  
P - 21cm

*Wharf  
Range*

- Warranty Conditions -

Any claim must be made within 12 Months from the date of purchase.  
To make a claim, take the product with a Receipt of proof of purchase to retailer.

- Warranty Exclusions -

1 - Fading due to weather exposure. 2 - Installation within 2km of salt water spray.  
3 - Damage to product through accident, misuse or negligence.

**- Exterior Range -**

**Parkway  
Range**

**1001395**

**PARKWAY**

**W/B**

**E27**

**FRAME SIZE**

H - 32cm W - 30cm  
P - 35cm

**Antique  
Bronze**

**IP - 44  
Rated**

*Globes  
Not  
Supplied*



**- NOTE -  
Chain  
Pendant  
Is For  
Interior  
Use  
Only**

**-  
Supplied  
With A  
1 MT  
Chain**

**1001392**

**PARKWAY  
CHAIN PND**

**E27**

**FRAME SIZE**

H - 28cm  
W - 30cm

**1001394**

**PARKWAY  
UNDER EAVE**

**E27**

**FRAME SIZE -**

H - 27cm W - 30cm



**- NOTE -  
Rod  
Pendant  
Is For  
Exterior  
Use**

**1001393**

**PARKWAY  
ROD PND**

**E27**

**FRAME SIZE**

H - 24cm W - 30cm  
+ 4 x 20cm RODS  
+ 1 x 5cm CAP

**- Warranty Conditions -**

Any claim must be made within 12 Months from the date of purchase.  
To make a claim, take the product with a Receipt of proof of purchase to retailer.

**- Warranty Exclusions -**

1 - Fading due to weather exposure. 2 - Installation within 2km of salt water spray.  
3 - Damage to product through accident, misuse or negligence.



**- Exterior Range -**

**Causeway  
Range**

**1001113**

**CAUSEWAY**

**W/B**

**E27**

**FRAME SIZE**

H - 37cm W - 29cm  
P - 40cm



*Globes  
Not  
Supplied*

**Antique  
Bronze**

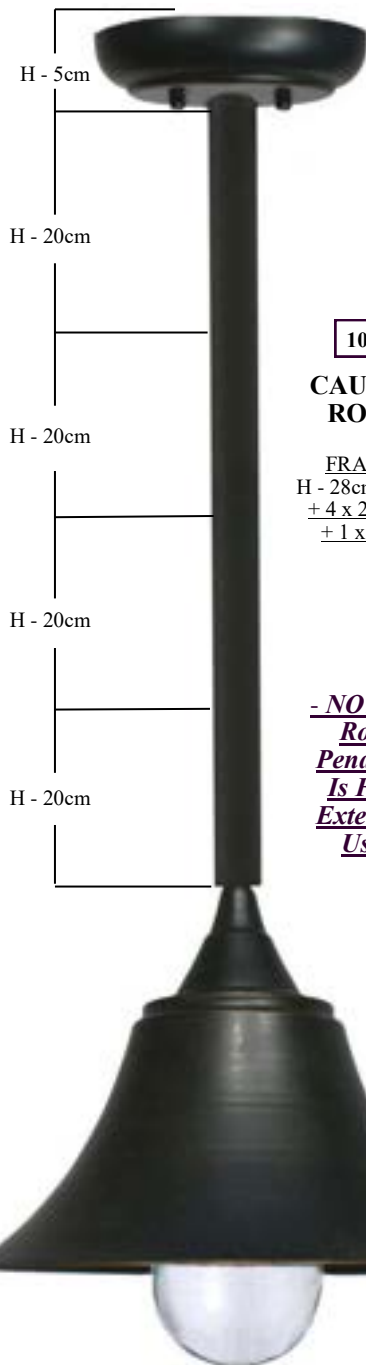

H - 5cm

H - 20cm

H - 20cm

H - 20cm

H - 20cm

**1001111**

**CAUSEWAY  
ROD PND**

**E27**

**FRAME SIZE**

H - 28cm W - 29cm  
+ 4 x 20cm RODS  
+ 1 x 5cm CAP

**- NOTE -  
Rod  
Pendant  
Is For  
Exterior  
Use**



**1001112**

**CAUSEWAY  
UNDER EAVE**

**E27**

**FRAME SIZE -**

H - 32cm W - 29cm

**IP - 44  
Rated**



**- NOTE -  
Chain  
Pendant  
Is For  
Interior  
Use  
Only  
-  
Supplied  
With A  
1MT  
Chain**

**1001110**

**CAUSEWAY  
CHAIN PND**

**E27**

**FRAME SIZE**

H - 34cm W - 29cm

**- Warranty Conditions -**

Any claim must be made within 12 Months from the date of purchase.  
To make a claim, take the product with a Receipt of proof of purchase to retailer.

**- Warranty Exclusions -**

1 - Fading due to weather exposure. 2 - Installation within 2km of salt water spray.  
3 - Damage to product through accident, misuse or negligence.

**- Exterior Range -**

**Riverside  
Range**

**Antique  
Black**

**IP - 03  
Rated**

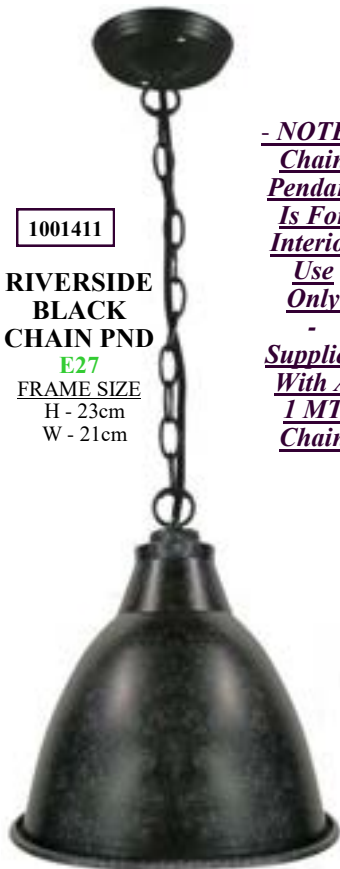

**1001411**  
**RIVERSIDE  
BLACK  
CHAIN PND**  
E27  
FRAME SIZE  
H - 23cm  
W - 21cm

**- NOTE -  
Chain  
Pendant  
Is For  
Interior  
Use  
Only  
-  
Supplied  
With A  
1 MT  
Chain**



**1001410**  
**RIVERSIDE BLACK W/B** E27  
FRAME SIZE  
H - 33cm W - 21cm P - 28cm



**1001412**  
**RIVERSIDE  
BLACK  
ROD PND**  
E27  
FRAME SIZE  
H - 21cm W - 21cm  
+ 4 x 20cm RODS  
+ 1 x 5cm CAP

H - 5cm  
H - 20cm  
H - 20cm  
H - 20cm  
H - 20cm



**1001413**  
**RIVERSIDE  
BLACK  
UNDER EAVE**  
E27  
FRAME SIZE  
H - 24cm W - 21cm

**Antique  
Bronze**

**IP - 03  
Rated**

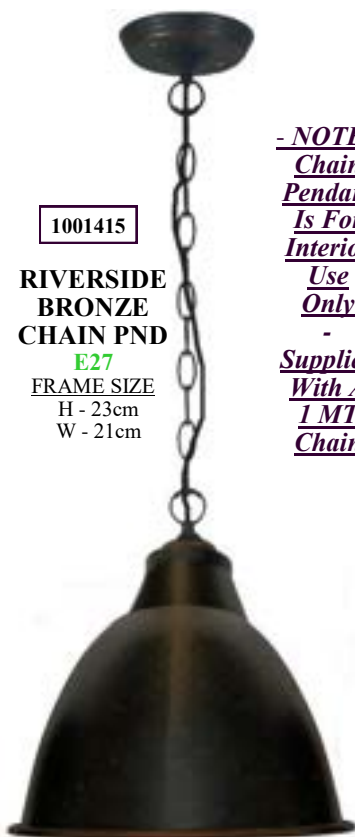

**1001415**  
**RIVERSIDE  
BRONZE  
CHAIN PND**  
E27  
FRAME SIZE  
H - 23cm  
W - 21cm

**- NOTE -  
Chain  
Pendant  
Is For  
Interior  
Use  
Only  
-  
Supplied  
With A  
1 MT  
Chain**



**1001414**  
**RIVERSIDE BRONZE W/B** E27  
FRAME SIZE  
H - 33cm W - 21cm P - 28cm

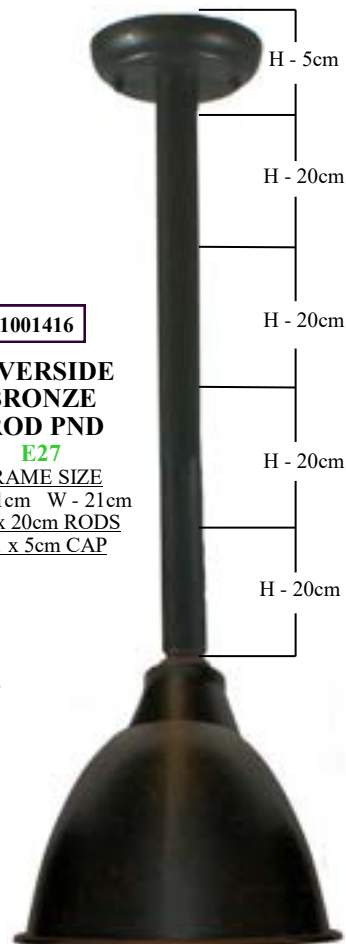

**1001416**  
**RIVERSIDE  
BRONZE  
ROD PND**  
E27  
FRAME SIZE  
H - 21cm W - 21cm  
+ 4 x 20cm RODS  
+ 1 x 5cm CAP

H - 5cm  
H - 20cm  
H - 20cm  
H - 20cm  
H - 20cm



**1001417**  
**RIVERSIDE  
BRONZE  
UNDER EAVE**  
E27  
FRAME SIZE  
H - 24cm W - 21cm

**- Exterior Range -**

**Southby  
Range**

**1000443**

**SOUTHBY  
W/B  
E27  
FRAME SIZE  
H - 31cm W - 21cm  
P - 26cm**



**Antique  
Bronze**

**- NOTE -  
Chain  
Pendant  
Is For  
Interior  
Use  
Only  
-  
Supplied  
With A  
1 MT  
Chain**

**- NOTE -  
Rod  
Pendant  
Is For  
Exterior  
Use**

**1000444**

**SOUTHBY  
CHAIN PND  
E27  
FRAME SIZE  
H - 22cm  
W - 21cm**



**1000463**

**SOUTHBY  
ROD PND  
E27  
FRAME SIZE  
H - 22cm W - 21cm  
+ 4 x 20cm RODS  
+ 1 x 5cm CAP**

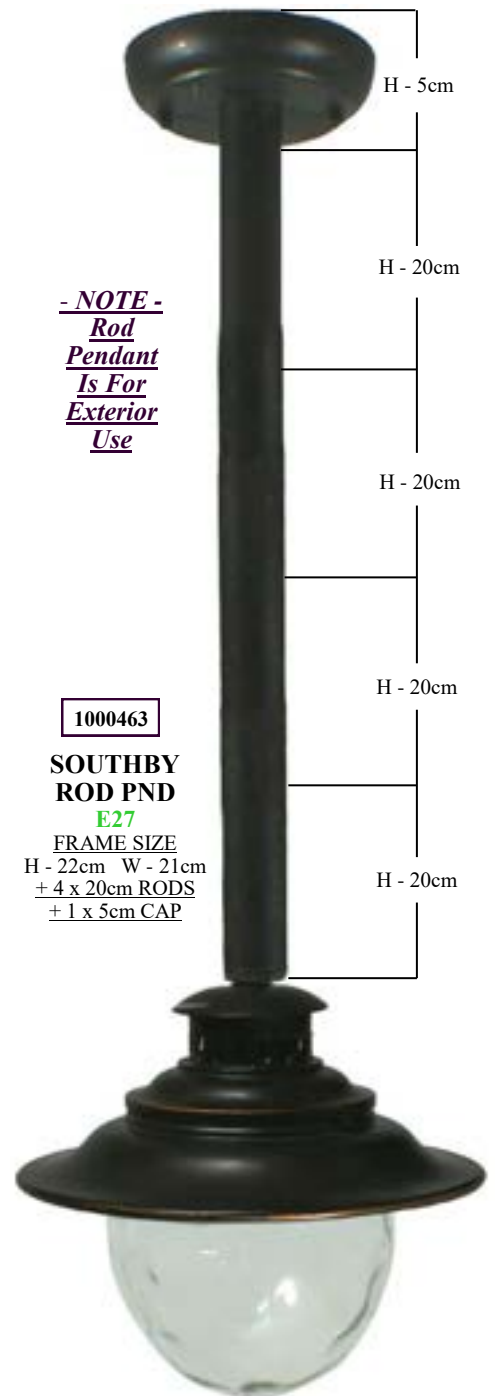

**1000442**

**SOUTHBY  
UNDER EAVE  
E27  
FRAME SIZE  
H - 22cm W - 21cm**



**IP - 44  
Rated**

**- Warranty Conditions -**

Any claim must be made within 12 Months from the date of purchase.  
To make a claim, take the product with a Receipt of proof of purchase to retailer.

**- Warranty Exclusions -**

1 - Fading due to weather exposure. 2 - Installation within 2km of salt water spray.  
3 - Damage to product through accident, misuse or negligence.

**- Exterior Range -**

***Laguna  
&  
Malibu  
Range***

***Matt  
Black***



**1000630**

**LAGUNA  
ROUND W/B**

**E27**

**FRAME SIZE**

H - 29cm W - 15cm

P - 18cm



**1000640**

**MALIBU  
SQUARE W/B**

**E27**

**FRAME SIZE**

H - 29cm W - 14cm

P - 18cm

***New***

***IP - 44  
Rated***

***- Warranty Conditions -***

*Any claim must be made within 12 Months from the date of purchase.  
To make a claim, take the product with a Receipt of proof of purchase to retailer.*

**89**

***- Warranty Exclusions -***

*1 - Fading due to weather exposure. 2 - Installation within 2km of salt water spray.  
3 - Damage to product through accident, misuse or negligence.*

**- Exterior Range -**

***Fairlight  
Range***



***Antique  
Black***

1000621

**FAIRLIGHT  
UNDER EAVE**

**E27**

**FRAME SIZE**

H - 65cm W - 22cm  
P - 39cm

***New***

***IP - 44  
Rated***



1000620

**FAIRLIGHT  
W/B**

**E27**

**FRAME SIZE**

H - 65cm W - 22cm  
P - 39cm

**- Warranty Conditions -**

Any claim must be made within 12 Months from the date of purchase.  
To make a claim, take the product with a Receipt of proof of purchase to retailer.

**90**

**- Warranty Exclusions -**

1 - Fading due to weather exposure. 2 - Installation within 2km of salt water spray.  
3 - Damage to product through accident, misuse or negligence.

**- Exterior Range -**

**Transit  
Range**

***Antique  
Bronze***



**1001529**  
TRANSIT  
MEDIUM W/B  
E27  
FRAME SIZE  
H - 49cm W - 23cm  
P - 28cm

**1001530**  
TRANSIT  
SMALL W/B  
E27  
FRAME SIZE  
H - 39cm W - 18cm  
P - 23cm



***Globes  
Not Supplied***

***New***



**1001528**  
TRANSIT  
MEDIUM  
UNDER EAVE  
E27  
FRAME SIZE  
H - 48cm W - 23cm

***- NOTE -  
Chain  
Pendant  
Is For  
Interior  
Use  
Only  
-  
Supplied  
With A  
1MT  
Chain***

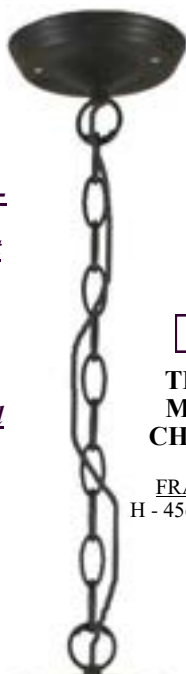

**1001525**  
TRANSIT  
MEDIUM  
CHAIN PND  
E27  
FRAME SIZE -  
H - 45cm W - 23cm

***- NOTE -  
Rod  
Pendant  
Is For  
Exterior  
Use***

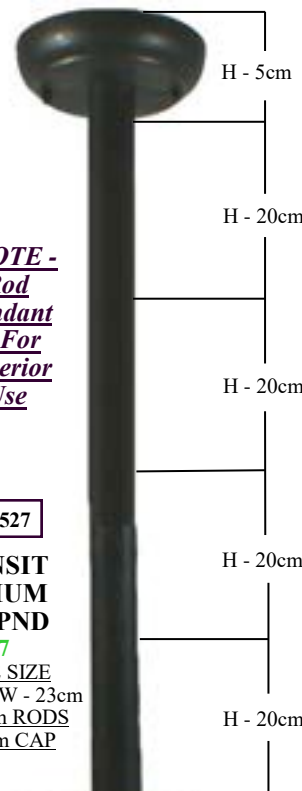

**1001527**  
TRANSIT  
MEDIUM  
ROD PND  
E27  
FRAME SIZE  
H - 45cm W - 23cm  
+ 4 x 20cm RODS  
+ 1 x 5cm CAP



**1001526**  
TRANSIT  
MEDIUM  
PILLAR MOUNT  
E27  
FRAME SIZE  
H - 68cm W - 23cm

***IP - 22  
Rated***



**- Warranty Conditions -**

Any claim must be made within 12 Months from the date of purchase. To make a claim, take the product with a Receipt of proof of purchase to retailer.

**- Warranty Exclusions -**

1 - Fading due to weather exposure. 2 - Installation within 2km of salt water spray. 3 - Damage to product through accident, misuse or negligence.

**- Exterior Range -**



1001434

**PROMENADE  
SMALL W/B**  
E27  
FRAME SIZE  
H - 30cm W - 18cm  
P - 22cm

*Antique  
Bronze*



1001433

**PROMENADE  
MEDIUM W/B**  
E27  
FRAME SIZE  
H - 39cm W - 23cm  
P - 28cm

*Promenade  
Range*

*New*

**- NOTE -  
Rod  
Pendant  
Is For  
Exterior  
Use**

1001431

**PROMENADE  
MEDIUM  
ROD PND**  
E27  
FRAME SIZE  
H - 35cm W - 23cm  
+ 4 x 20cm RODS  
+ 1 x 5cm CAP

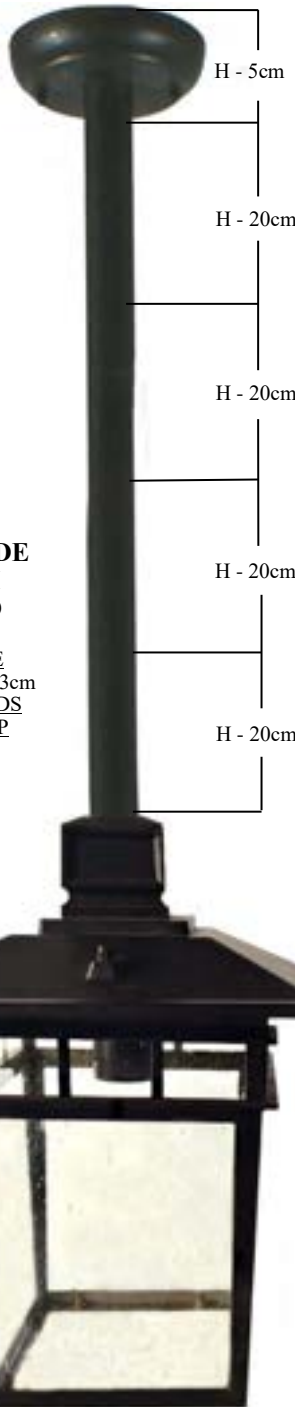

**- NOTE -  
Chain  
Pendant  
Is For  
Interior  
Use  
Only  
-  
Supplied  
With A  
1 MT  
Chain**

1001430

**PROMENADE  
MEDIUM  
CHAIN PND**  
E27  
FRAME SIZE -  
H - 37cm W - 23cm



1001432

**PROMENADE  
MEDIUM  
UNDER EAVE**  
E27  
FRAME SIZE  
H - 39cm W - 23cm



*IP - 03  
Rated*

**- Warranty Conditions -**

Any claim must be made within 12 Months from the date of purchase.  
To make a claim, take the product with a Receipt of proof of purchase to retailer.

**- Warranty Exclusions -**

1 - Fading due to weather exposure. 2 - Installation within 2km of salt water spray.  
3 - Damage to product through accident, misuse or negligence.

**- Exterior Range -**

**Boulevard  
Range**

**Antique  
Black**

**1000822**

**BOULEVARD  
MEDIUM W/B E27**

**FRAME SIZE -  
H - 46cm W - 18cm P - 25cm**



**1000823**

**BOULEVARD  
SMALL W/B E27**

**FRAME SIZE -  
H - 37cm W - 18cm P - 25cm**

**New**



**1000821**

**BOULEVARD  
LARGE W/B E27**

**FRAME SIZE -  
H - 54cm W - 18cm P - 25cm**

**- NOTE -  
Chain  
Pendant  
Is For  
Interior  
Use  
Only  
-  
Supplied  
With A  
1 MT  
Chain**



**IP - 44  
Rated**

**1000824**

**BOULEVARD  
SMALL  
CHAIN  
E27**

**FRAME SIZE -  
H - 34cm W - 18cm**

**- NOTE -  
Rod  
Pendant  
Is For  
Exterior  
Use**

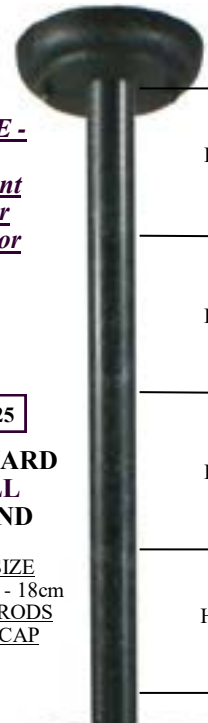

H - 5cm

H - 20cm

H - 20cm

H - 20cm

H - 20cm

**1000825**

**BOULEVARD  
SMALL  
ROD PND  
E27**

**FRAME SIZE  
H - 30cm W - 18cm  
+ 4 x 20cm RODS  
+ 1 x 5cm CAP**





**- Exterior Range -**

***Plaza & Portico  
Range***



1000856

**PORTICO  
MEDIUM  
WALL SCNCE  
MATT BLACK**

**E27**

FRAME SIZE

H - 41cm

W - 15cm

P - 17cm

***New***

***Matt  
Black***



1000857

**PORTICO  
SMALL  
WALL SCNCE  
MATT BLACK**

**E27**

FRAME SIZE

H - 36cm

W - 13cm

P - 13cm

***IP - 44  
Rated***



1000853

**PLAZA  
WALL SCNCE  
ANTIQU BLACK E27**

FRAME SIZE

H - 58cm W - 20cm P - 13cm

***Antique  
Black***

**- Warranty Conditions -**

Any claim must be made within 12 Months from the date of purchase.  
To make a claim, take the product with a Receipt of proof of purchase to retailer.

94

**- Warranty Exclusions -**

1 - Fading due to weather exposure. 2 - Installation within 2km of salt water spray.  
3 - Damage to product through accident, misuse or negligence.

**- Exterior Range -**

***Frontage  
Range***

***Antique  
Black***

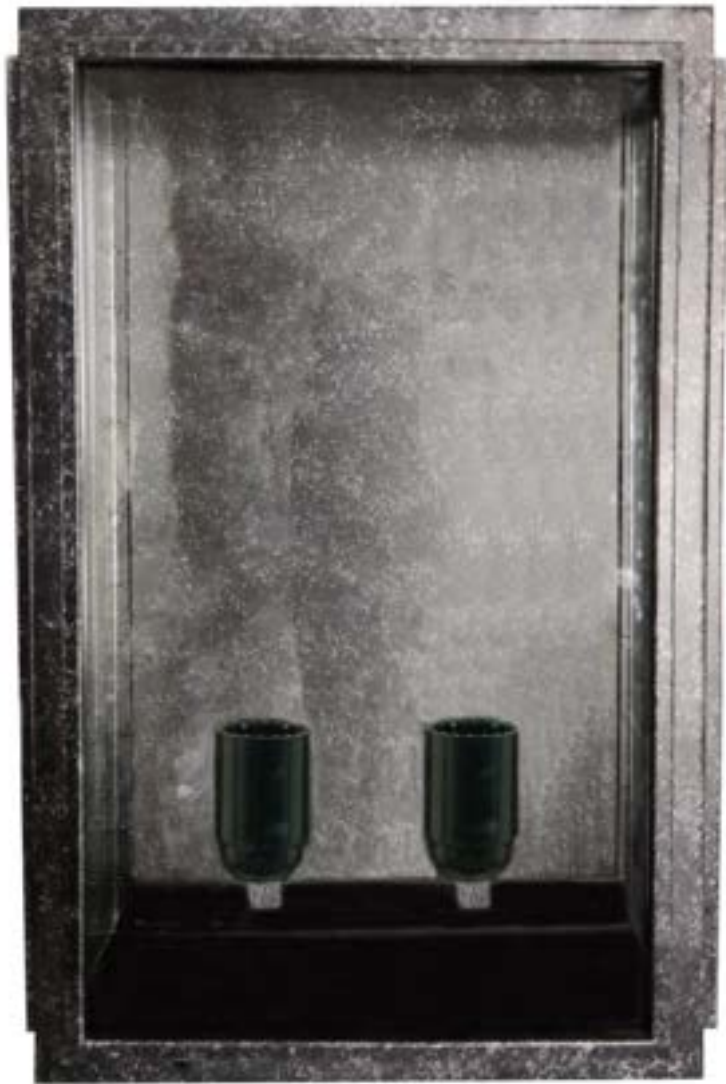

1001213

**FRONTAGE LARGE  
WALL SCONCE E27**  
FRAME SIZE  
H - 44cm W - 28cm P - 14cm



1001214

**FRONTAGE MEDIUM  
WALL SCONCE E27**  
FRAME SIZE  
H - 34cm W - 22cm P - 12cm



1001215

**FRONTAGE SMALL  
WALL SCONCE E27**  
FRAME SIZE  
H - 26cm W - 17cm P - 9cm

***IP - 44  
Rated***

**- Warranty Conditions -**

Any claim must be made within 12 Months from the date of purchase.  
To make a claim, take the product with a Receipt of proof of purchase to retailer.

**- Warranty Exclusions -**

1 - Fading due to weather exposure. 2 - Installation within 2km of salt water spray.  
3 - Damage to product through accident, misuse or negligence.

**- Exterior Range -**

**Montrose  
&  
Loft  
Range**

**Antique  
Bronze**



1000338

**MONTROSE SMALL  
WALL SCONCE E27**

FRAME SIZE -  
H - 35cm W - 22cm P - 12cm



1000340

**MONTROSE LARGE  
WALL SCONCE E27**

FRAME SIZE -  
H - 45cm W - 28cm P - 14cm



1000293

**LOFT  
WALL SCONCE E27**

FRAME SIZE -  
H - 34cm W - 15cm P - 12cm

**IP - 44  
Rated**

**- Warranty Conditions -**

Any claim must be made within 12 Months from the date of purchase.  
To make a claim, take the product with a Receipt of proof of purchase to retailer.

96

**- Warranty Exclusions -**

1 - Fading due to weather exposure. 2 - Installation within 2km of salt water spray.  
3 - Damage to product through accident, misuse or negligence.

**- Exterior Range -**

***Wickham  
Range***

***Antique  
Bronze***



1000599

**WICKHAM  
ANTIQUE BRONZE  
UNDER EAVE 2/LT**

**E27**

**FRAME SIZE  
H - 21cm W - 35cm**

***IP - 44  
Rated***

***Antique  
Black***



1000598

**WICKHAM  
ANTIQUE BLACK  
UNDER EAVE 2/LT**

**E27**

**FRAME SIZE  
H - 21cm W - 35cm**

***IP - 44  
Rated***

**- Warranty Conditions -**

Any claim must be made within 12 Months from the date of purchase.  
To make a claim, take the product with a Receipt of proof of purchase to retailer.

**- Warranty Exclusions -**

1 - Fading due to weather exposure. 2 - Installation within 2km of salt water spray.  
3 - Damage to product through accident, misuse or negligence.

# - Exterior Range -

## *Accessory Range*

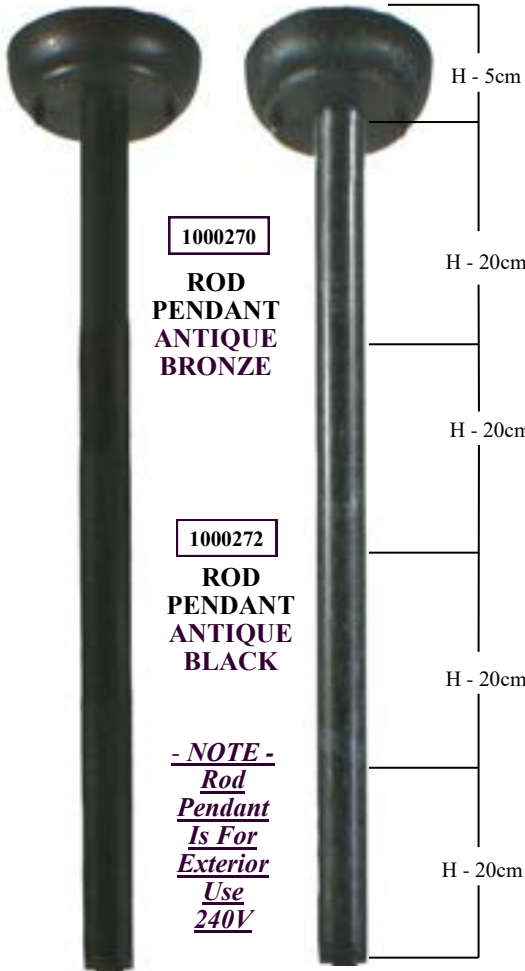

**1000270**  
**ROD  
PENDANT  
ANTIQUE  
BRONZE**

**1000272**  
**ROD  
PENDANT  
ANTIQUE  
BLACK**

**- NOTE -**  
**Rod**  
**Pendant**  
**Is For**  
**Exterior**  
**Use**  
**240V**

**1000152**  
**DOMAIN  
POST  
ANTIQUE  
BRONZE  
TOTAL  
HEIGHT  
226cm**

**1000151**  
**DOMAIN  
POST  
ANTIQUE  
BLACK  
TOTAL  
HEIGHT  
226cm**

**1000709**  
**STANDARD  
POST  
ANTIQUE  
BRONZE  
TOTAL  
HEIGHT  
182cm**

**1000708**  
**STANDARD  
POST  
ANTIQUE  
BLACK  
TOTAL  
HEIGHT  
182cm**



**1000306**  
**CHAIN  
PENDANT  
ANTIQUE  
BRONZE**

**1000308**  
**CHAIN  
PENDANT  
ANTIQUE  
BLACK**

**- NOTE -**  
**Chain Pendant**  
**Is For Interior**  
**Use Only 240V**  
**Or To Comply**  
**For Exterior Use**  
**It Has To Be**  
**Wired With A**  
**12V Transformer**  
**Using A**  
**12V ES Globe**  
**-**  
**Supplied With A**  
**1 MT Chain**



**- Warranty Conditions -**

Any claim must be made within 12 Months from the date of purchase.  
To make a claim, take the product with a Receipt of proof of purchase to retailer.

**- Warranty Exclusions -**

1 - Fading due to weather exposure. 2 - Installation within 2km of salt water spray.  
3 - Damage to product through accident, misuse or negligence.

**- Brass Range -**

**Accessories  
In  
Polished Brass**



**2 1/4" GALLERY  
BRASS -29mm HOLE** 3006061



**3 1/4" GALLERY  
BRASS -29mm HOLE** 3006062



**4 1/4" GALLERY  
BRASS -29mm HOLE** 3006063



**6 1/4" GALLERY  
BRASS -29mm HOLE** 3006064



**8 1/4" GALLERY  
BRASS -29mm HOLE** 3006065



**12 1/4" GALLERY  
BRASS -29mm HOLE** 3006060



3006013  
**BATTEN COVER  
BRASS -29mm HOLE**



3006006  
**3 CHAIN  
SUSP  
BROWN CORD  
W-HOOKS  
1 MT  
BRASS  
B22**

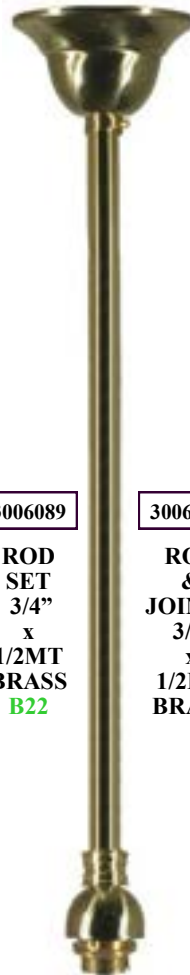

3006089  
**ROD  
SET  
3/4"  
x  
1/2MT  
BRASS  
B22**

3006072  
**ROD  
&  
JOINER  
3/4"  
x  
1/2MT  
BRASS**



3006087  
**ROD  
SET  
1/2"  
X  
1/2MT  
BRASS  
B22**



3006071  
**ROD  
&  
JOINER  
1/2"  
x  
1/2MT  
BRASS**

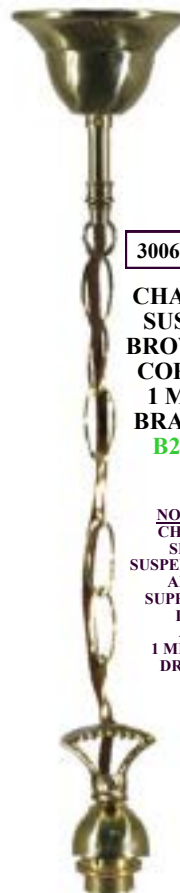

3006092  
**CHAIN  
SUSP  
BROWN  
CORD  
1 MT  
BRASS  
B22**

NOTE -  
CHAIN  
SET  
SUSPENSIONS  
ARE  
SUPPLIED  
IN  
A  
1 METER  
DROP.



3006037  
**CLOTH  
BROWN  
CORD  
SUSP  
1 MT  
BRASS  
B22**

NOTE -  
CLOTH CORD  
SET  
SUSPENSIONS  
ARE  
SUPPLIED  
IN  
A  
1 METER  
DROP.

**- Brass Range -**

**Wall  
Bracket  
Range**

*\* Wall Brackets  
Can Be  
Installed  
Either  
Facing Up  
Or  
Facing Down*



**3000327**

**7011  
WALL SCONCE  
BRASS B22**  
H-33cm W-15cm  
P-10cm



**3000022**

**CLAREDON 6"  
B/F BRASS B22**  
H-20cm W-15cm



**3000332**

**WAUBRA  
1/LT W/B BRASS  
5008 29mm FROST  
ETCHED B22**  
H - 20cm W - 14cm P - 18cm



**3000334**

**WAUBRA 1/LT W/B BRASS  
CONO OPAL MATT B22**  
H-20cm W-14cm P-19cm



**3000333**

**WAUBRA 1/LT W/B BRASS  
CONO CLEAR B22**  
H-20cm W-14cm P-19cm



**3000154**

**KOSCINA 1/LT W/B BRASS  
CONO OPAL MATT B22**  
H-20cm W-14cm P-16cm



**3000153**

**KOSCINA 1/LT W/B BRASS  
CONO CLEAR B22**  
H-20cm W-14cm P-16cm



**3000337**

**WAUBRA 1/LT W/B BRASS  
DECATRON B22**  
H-19cm W-12cm P-19cm



**3000155**

**KOSCINA 1/LT W/B BRASS  
DECATRON OPAL MATT B22**  
H-19cm W-12cm P-16cm



**3000336**

**KLINE 1/LT W/B BRASS  
ZIPPER 23 FROST B22**  
H-22cm W-12cm P-16cm



**3000335**

**KLINE 1/LT W/B BRASS  
ZIPPER 23 CLEAR B22**  
H-22cm W-12cm P-16cm



**3000175**

**LOXTON 1/LT W/B BRASS  
CONO OPAL MATT B22**  
H - 22cm W - 14cm P - 22cm



**3000180**

**LOXTON 1/LT W/B BRASS  
DECATRON OPAL MATT B22**  
H - 22cm W - 12cm P - 21cm



**3001175**

**LOXTON 1/LT W/B BRASS  
CONO CLEAR B22**  
H - 22cm W - 14cm P - 22cm



**3000351**

**KOSCINA 1/LT W/B BRASS  
SPHERE 6" OPAL GLOSS B22**  
H - 26cm W - 15cm P - 16cm

**- Brass Range -**

**Luke  
Range**

**3000187**

**LUKE  
1/LT W/B BRASS  
SHEFFIELD 6" B22**  
H - 32cm W - 15cm  
P - 26cm



**3000191**

**LUKE  
5/LT PND BRASS  
SHEFFIELD 6"  
1/2"x 1/2MT B22**  
H - 66cm (ADJ) W - 56cm



**3000189**

**LUKE  
3/LT PND BRASS  
SHEFFIELD 6"  
1/2"x 1/2MT B22**  
H - 66cm (ADJ) W - 52cm



**NOTE -**  
-----  
1/2"x 1/2MT  
ROD & JOINER  
EXTENSIONS  
AVAILABLE

**3000188**

**LUKE  
3/LT PND BRASS  
SPHERE 6" OPAL GLOSS  
1/2"x 1/2MT B22**  
H - 66cm (ADJ) W - 52cm



**3000190**

**LUKE  
5/LT PND BRASS  
SPHERE 6" OPAL GLOSS  
1/2"x 1/2MT B22**  
H - 66cm (ADJ) W - 56cm



**3000186**

**LUKE  
1/LT W/B BRASS  
SPHERE 6" OPAL GLOSS B22**  
H - 32cm W - 15cm P - 26cm





**- Brass Range -**

***Victoriana  
&  
Cambridge  
Range***

**3001279**

**CAMBRIDGE  
ROD PND  
3/4" x 1/2MT  
BRASS B22  
H - 75cm (ADJ)  
W - 22cm**



**3000316**

**VICTORIANA  
1/LT W/B BRASS  
5008 29mm B22  
H - 20cm W - 12cm  
P - 29cm**



**3000320**

**VICTORIANA  
3/LT PND BRASS  
5008 29mm  
1/2" x 1/2MT B22  
H - 75cm (ADJ) W - 62cm**



**NOTE -**

**1/2" x 1/2MT  
ROD & JOINER  
EXTENSIONS  
AVAILABLE**

**3000324**

**VICTORIANA  
5/LT PND BRASS  
5008 29mm  
1/2" x 1/2MT B22  
H - 75cm (ADJ) W - 67cm**



**3000056**

**CAMBRIDGE  
B/F BRASS B22  
H - 38cm W - 22cm**



**- Brass Range -**

**St Kilda  
Range**

**NOTE -**  
CHAIN  
SET  
SUSPENSIONS  
ARE  
SUPPLIED  
IN  
A  
1 METER  
DROP.

**3000095**

**ST KILDA 8" OPAL MATT SINGLECHAIN BROWN CORD SUSP BRASS B22**  
H-100cm(ADJ)  
W-21cm

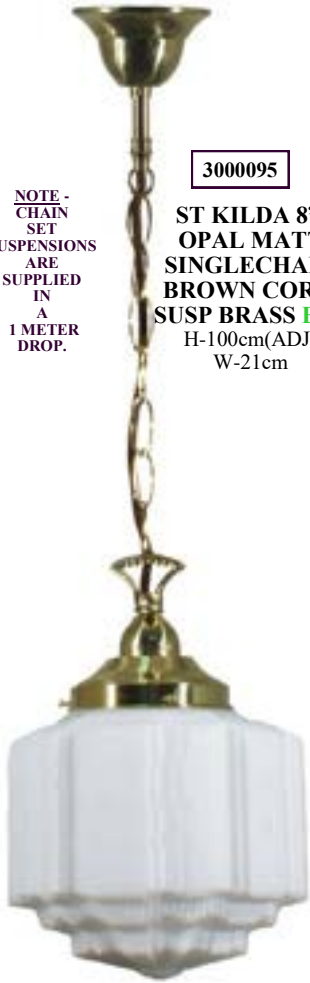

**NOTE -**  
CLOTH CORD  
SET  
SUSPENSIONS  
ARE  
SUPPLIED  
IN  
A  
1 METER  
DROP.

**3000113**

**ST KILDA 8" OPAL MATT CLOTH BROWN CORD SUSP BRASS B22**  
H-100cm(ADJ)  
W-21cm



**NOTE -**  
HALF  
METER  
1/2" & 3/4"  
ROD  
&  
JOINER  
EXTENSIONS  
AVAILABLE

**3000286**

**ST KILDA 14" OPAL MATT ROD PND 3/4" x 1/2MT BRASS B22**  
H-75cm(ADJ)  
W-36cm



**3000262**

**ST KILDA 8" OPAL MATT ROD PND 1/2" x 1/2MT BRASS B22**  
H-73cm(ADJ)  
W-21cm



**NOTE -**  
3 CHAIN  
SUSPENSION  
ARE  
SUPPLIED  
IN  
A  
1 METER  
DROP  
WITH  
HOOKS

**3000013**

**ST KILDA 14" OPAL MATT 3 CHAIN SUSP BRASS B22**  
H-100cm (ADJ)  
W-34cm



**3000051**

**ST KILDA 8" OPAL MATT B/F BRASS B22**  
H-22cm W-21cm



**3000019**

**ST KILDA 14" OPAL MATT B/F BRASS B22**  
H-29cm W-36cm



# - Brass Range -

## Senator Range

**300112**

**SENATOR 17"**  
**OPAL MATT**  
**3 CHAIN**  
**SUSP**  
**BRASS B22**  
H-100cm (ADJ)  
W-42cm



**3000012**

**SENATOR 14"**  
**OPAL MATT**  
**3 CHAIN**  
**SUSP**  
**BRASS B22**  
H-100cm (ADJ)  
W-34cm



**3000009**

**SENATOR 11"**  
**OPAL MATT**  
**3 CHAIN**  
**SUSP**  
**BRASS B22**  
H-100cm (ADJ)  
W-28cm



**3000111**

**SENATOR 8"**  
**OPAL**  
**MATT**  
**CLOTH**  
**BROWN**  
**CORD SUSP**  
**BRASS B22**  
H-100cm(ADJ)  
W-20cm

NOTE -  
CLOTH CORD  
SET  
SUSPENSIONS  
ARE  
SUPPLIED  
IN  
A  
1 METER  
DROP.



**3000018**

**SENATOR 14" OPAL MATT**  
**B/F BRASS B22**  
H-32cm W-36cm

**3000257**

**SENATOR 8"**  
**OPAL MATT**  
**ROD PND**  
**1/2"x 1/2MT**  
**BRASS B22**  
H-75cm (ADJ)  
W-20cm

NOTE -  
HALF  
METER  
1/2" & 3/4"  
ROD  
&  
JOINER  
EXTENSIONS  
AVAILABLE



**3000093**

**SENATOR**  
**8"**  
**OPAL**  
**MATT**  
**SINGLE**  
**CHAIN**  
**BROWN**  
**CORD**  
**SUSP**  
**BRASS B22**  
H-100cm  
W-20cm

NOTE -  
CHAIN  
SET  
SUSPENSIONS  
ARE  
SUPPLIED  
IN  
A  
1 METER  
DROP.



**3000067**

**SENATOR 11" OPAL MATT**  
**B/F BRASS B22**  
H-28cm W-28cm

**3000285**

**SENATOR 14"**  
**OPAL MATT**  
**ROD PND**  
**3/4"x 1/2MT**  
**BRASS B22**  
H-75cm(ADJ)  
W-36cm



**3000247**

**SENATOR**  
**11"**  
**OPAL**  
**MATT**  
**ROD PND**  
**1/2"x 1/2MT**  
**BRASS B22**  
H-70cm(ADJ)  
W-28cm



**3000046**

**SENATOR 8" OPAL MATT**  
**B/F BRASS B22**  
H-23cm W-20cm



**- Brass Range -**

**Empire Range**

NOTE - CLOTH CORD SET SUSPENSIONS ARE SUPPLIED IN A 1 METER DROP.



**3001111**

**EMPIRE 8" OPAL MATT CLOTH BROWN CORD SUSP BRASS B22**  
H-100cm(ADJ)  
W-20cm

NOTE - CHAIN SET SUSPENSIONS ARE SUPPLIED IN A 1 METER DROP.



**3001192**

**EMPIRE 8" OPAL MATT SINGLE CHAIN SUSP BROWN CORD BRASS B22**  
H-100cm(ADJ)  
W-20cm

NOTE - HALF METER 1/2" & 3/4" ROD & JOINER EXTENSIONS AVAILABLE



**3001242**

**EMPIRE 8" OPAL MATT ROD PND BRASS B22**  
1/2"x 1/2MT  
H-100cm (ADJ)  
W-20cm

**3001278**

**EMPIRE 14" OPAL MATT ROD PND 3/4"x 1/2MT BRASS B22**  
H-100cm (ADJ)  
W-36cm



**3000043**

**EMPIRE 8" OPAL MATT B/F BRASS B22**  
H-27cm W-20cm



**3000011**

**EMPIRE 14" OPAL MATT 3 CHAIN SUSP BRASS B22**  
H-100cm(ADJ)  
W-36cm

NOTE - 3 CHAIN SUSPENSION ARE SUPPLIED IN A 1 METER DROP WITH HOOKS



**3000017**

**EMPIRE 14" OPAL MATT B/F BRASS B22**  
H-25cm W-20cm



**- Brass Range -**

**Premier  
Range**

**NOTE -**  
HALF  
METER  
1/2" & 3/4"  
ROD  
&  
JOINER  
EXTENSIONS  
AVAILABLE

**3000280**

**PREMIER  
12"  
OPAL MATT  
ROD PND  
3/4"x 1/2MT  
BRASS B22  
H-80cm(ADJ)  
W-30cm**

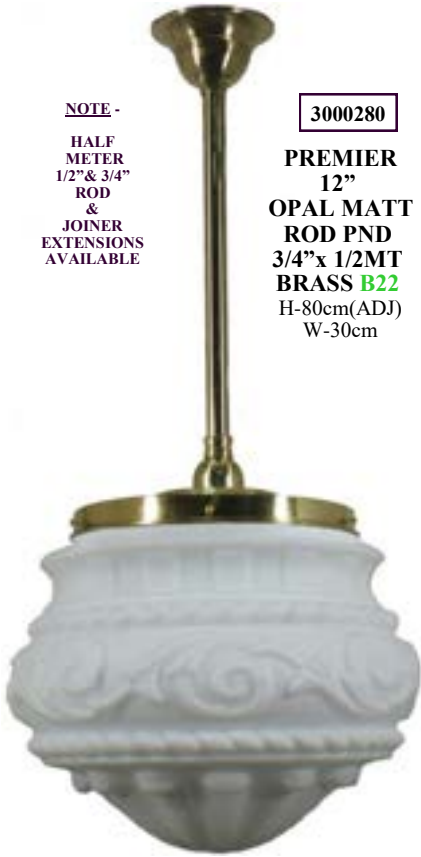

**NOTE -**  
CLOTH CORD  
SET  
SUSPENSIONS  
ARE  
SUPPLIED  
IN  
A  
1 METER  
DROP.

**3001113**

**PREMIER 8"  
OPAL MATT  
CLOTH  
BROWN  
CORD SUSP  
BRASS B22  
H-100cm(ADJ)  
W-23cm**



**NOTE -**  
CHAIN  
SET  
SUSPENSIONS  
ARE  
SUPPLIED  
IN  
A  
1 METER  
DROP.

**3001193**

**PREMIER 8"  
OPAL MATT  
SINGLE  
CHAIN SUSP  
BROWN CORD  
BRASS B22  
H-100cm(ADJ)  
W-23cm**



**3000256**

**PREMIER 8"  
OPAL MATT  
ROD PND  
1/2"x 1/2MT  
BRASS B22  
H-75cm(ADJ)  
W-23cm**



**NOTE -**  
3 CHAIN  
SUSPENSION  
ARE  
SUPPLIED  
IN  
A  
1 METER  
DROP  
WITH  
HOOKS

**3000010**

**PREMIER 12"  
OPAL MATT  
3 CHAIN  
SUSP  
BRASS B22  
H-100cm(ADJ)  
W-30cm**

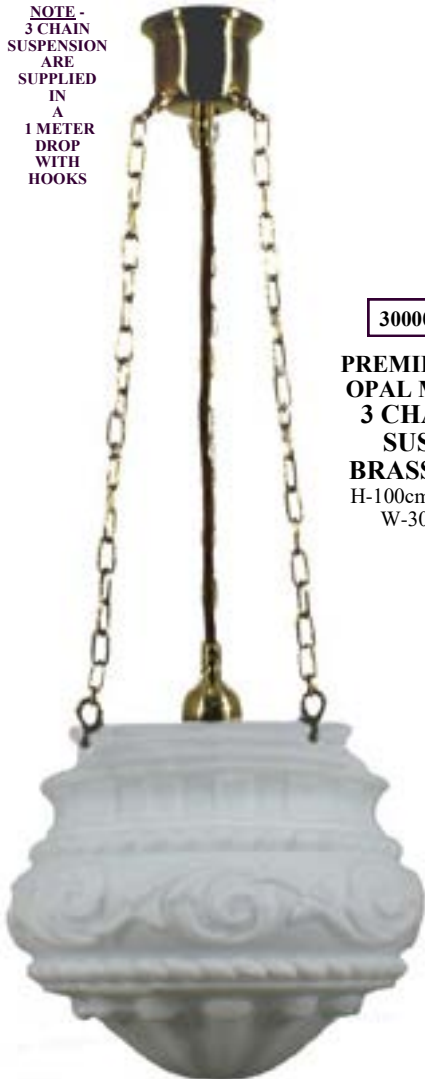

**3000045**

**PREMIER 8"  
OPAL MATT  
B/F BRASS B22  
H-23cm W-23cm**



**3000068**

**PREMIER 12"  
OPAL MATT  
B/F BRASS B22  
H-32cm W-30cm**



**- Brass Range -**

**R/S  
& B/F  
Range**

**NOTE -**  
HALF  
METER  
1/2" & 3/4"  
ROD  
&  
JOINER  
EXTENSIONS  
AVAILABLE

**3000287**

**VICTORIAN 16" SCHOOLHOUSE  
OPAL MATT  
ROD PND  
3/4" x 1/2MT  
BRASS B22  
H-85cm(ADJ)  
W-40cm**



**3000252**

**VICTORIAN 12" SCHOOLHOUSE  
OPAL MATT  
ROD PND  
1/2" x 1/2MT  
BRASS B22  
H-75cm(ADJ)  
W-30cm**



**3000266**

**VICTORIAN 9" SCHOOLHOUSE  
OPAL MATT  
ROD PND  
1/2" x 1/2MT  
BRASS B22  
H-70cm(ADJ)  
W-23cm**



**3000055**

**VICTORIAN 9" SCHOOLHOUSE  
OPAL MATT  
B/F  
BRASS B22  
H-19cm W-23cm**



**3000064**

**VICTORIAN 16" SCHOOLHOUSE OPAL MATT  
B/F BRASS B22  
H-30cm W-40cm**



**3000041**

**VICTORIAN 12" SCHOOLHOUSE  
OPAL MATT  
B/F  
BRASS B22  
H-23cm W-30cm**



**NOTE -**  
HALF  
METER  
1/2" & 3/4"  
ROD  
&  
JOINER  
EXTENSIONS  
AVAILABLE

**3000289**

**LINCOLN SCHOOLHOUSE  
OPAL MATT  
ROD PND  
3/4" x 1/2MT  
BRASS B22  
H-85cm (ADJ)  
W-36cm**

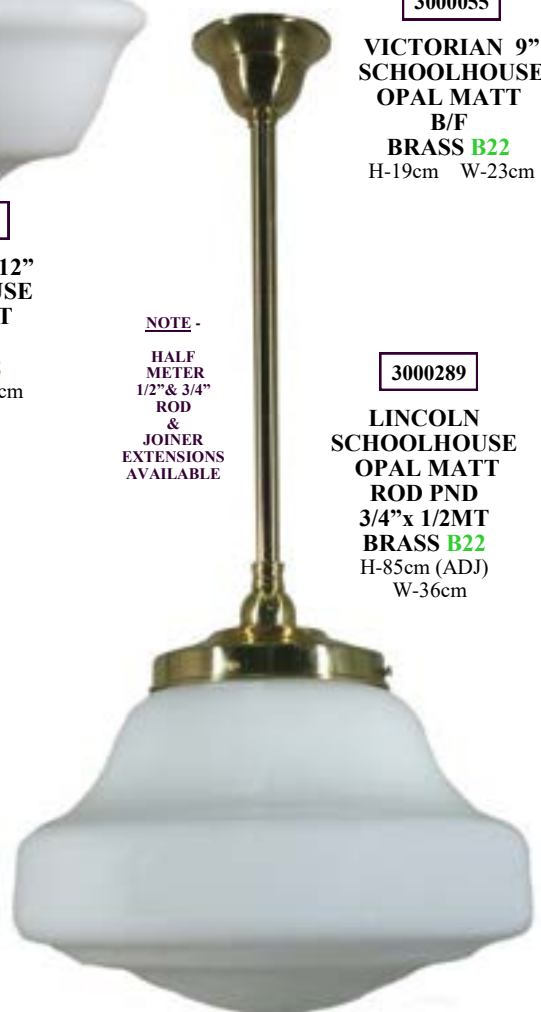

**New  
Opal  
Matt**

**3000066**

**LINCOLN SCHOOLHOUSE OPAL MATT  
B/F BRASS B22  
H-27cm W-36cm**



**- Brass Range -**

***R/S  
& B/F  
Range***

3000284

**DETROIT 14"**  
**OPAL MATT**  
**ROD PND**  
**3/4"x 1/2MT**  
**BRASS B22**  
H-78cm(ADJ)  
W-34cm



3000063

**DETROIT 14"**  
**OPAL MATT**  
**B/F BRASS B22**  
H-28cm W-34cm



3000042

**DETROIT 8"**  
**OPAL MATT**  
**B/F BRASS B22**  
H-24cm W-20cm



3000288

**BERGERAC**  
**OPAL MATT**  
**ROD PND**  
**3/4"x 1/2MT**  
**BRASS B22**  
H-94cm (ADJ)  
W-26cm



**NOTE -**  
HALF  
METER  
1/2" & 3/4"  
ROD  
&  
JOINER  
EXTENSIONS  
AVAILABLE

3000253

**DETROIT 8"**  
**OPAL MATT**  
**ROD PND**  
**1/2"x 1/2MT**  
**BRASS B22**  
H-72cm(ADJ) W-20cm

***New  
Opal  
Matt***

3000273

**MOULINS**  
**OPAL MATT**  
**ROD PND**  
**1/2"x 1/2MT**  
**BRASS B22**  
H-70cm(ADJ)  
W-30cm



3000061

**MOULINS**  
**OPAL MATT**  
**B/F BRASS B22**  
H-21cm W-30cm



3000268

**CHATEAU**  
**OPAL MATT**  
**ROD PND**  
**1/2"x 1/2MT**  
**BRASS B22**  
H-70cm(ADJ)  
W-28cm



3000065

**CHATEAU**  
**OPAL MATT**  
**B/F BRASS B22**  
H-21cm W-30cm



**- Brass Range -**

**R/S  
& B/F  
Range**



**3000283**

**DERBY 13" OPAL MATT  
ROD PND  
3/4" x 1/2MT  
BRASS B22  
H-80cm(ADJ)  
W-33cm**



**3000062**

**DERBY 13" OPAL MATT  
B/F BRASS B22  
H-30cm W-33cm**



**3000053**

**DERBY 9" OPAL MATT  
B/F BRASS B22  
H-25cm W-23cm**



**3000267**

**CANNES  
OPAL MATT  
ROD PND  
1/2" x 1/2MT  
BRASS B22  
H-70cm(ADJ)  
W-22cm**



**3000264**

**DERBY 9" OPAL MATT  
ROD PND  
1/2" x 1/2MT  
BRASS B22  
H-75cm(ADJ) W-23cm**



**3000057**

**CANNES  
OPAL MATT  
B/F BRASS B22  
H-19cm W-22cm**

*New  
Opal  
Matt*

**NOTE -  
HALF  
METER  
1/2" & 3/4"  
ROD  
&  
JOINER  
EXTENSIONS  
AVAILABLE**



**3000058**

**DOMEC  
OPAL MATT  
B/F BRASS B22  
H-21cm W-20cm**



**3000034**

**BEEHIVE 10"  
OPAL MATT  
B/F BRASS B22  
H-22cm W-25cm**



**3000054**

**PARKVILLE 9"  
OPAL MATT  
B/F BRASS B22  
H-21cm W-23cm**



**3000270**

**DOMEC  
OPAL MATT  
ROD PND  
1/2" x 1/2MT  
BRASS B22  
H-70cm(ADJ)  
W-20cm**



**3000243**

**BEEHIVE 10"  
OPAL MATT  
ROD PND  
1/2" x 1/2MT  
BRASS B22  
H-70cm (ADJ) W-25cm**



**3000265**

**PARKVILLE 9"  
OPAL MATT  
ROD PND  
1/2" x 1/2MT  
BRASS B22  
H-68cm(ADJ) W-23cm**



# - Brass Range -



**3000039**  
**SPHERE**  
**12"**  
**OPAL**  
**GLOSS**  
**B/F**  
**BRASS**  
**B22**  
 H-34cm  
 W-30cm



**3000035**  
**SPHERE**  
**10"**  
**OPAL**  
**GLOSS**  
**B/F**  
**BRASS**  
**B22**  
 H-28cm  
 W-25cm



**3000044**  
**SPHERE**  
**8"**  
**OPAL**  
**GLOSS**  
**B/F**  
**BRASS**  
**B22**  
 H-22cm  
 W-20cm



**3000029**  
**SPHERE**  
**6"**  
**OPAL**  
**GLOSS**  
**B/F**  
**BRASS**  
**B22**  
 H-17cm  
 W-15cm

**NOTE -**  
 HALF  
 METER  
 1/2" & 3/4"  
 ROD  
 &  
 JOINER  
 EXTENSIONS  
 AVAILABLE



**3000278**  
**SPHERE 12"**  
**OPAL**  
**GLOSS**  
**ROD PND**  
**3/4" x 1/2MT**  
**BRASS**  
**B22**  
 H-86cm (ADJ)  
 W-30cm



**3000242**  
**SPHERE 10"**  
**OPAL**  
**GLOSS**  
**ROD PND**  
**1/2" x 1/2MT**  
**BRASS**  
**B22**  
 H-80cm (ADJ)  
 W-25cm

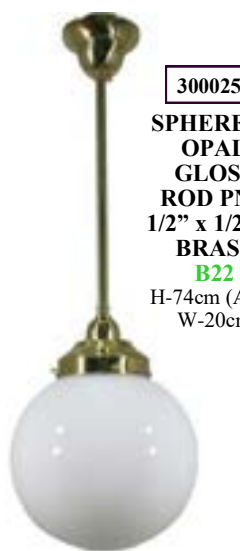

**3000254**  
**SPHERE 8"**  
**OPAL**  
**GLOSS**  
**ROD PND**  
**1/2" x 1/2MT**  
**BRASS**  
**B22**  
 H-74cm (ADJ)  
 W-20cm



**3001190**  
**SPHERE 10"**  
**OPAL**  
**GLOSS**  
**SINGLE**  
**CHAIN**  
**SUSP**  
**BROWN**  
**CORD**  
**BRASS B22**  
 H-100cm +(ADJ)  
 W-25cm

**NOTE -**  
 CHAIN SET & SUSPENSIONS  
 ARE  
 SUPPLIED IN A 1 METER DROP.



**3000040**  
**SHEFFIELD**  
**12"**  
**B/F**  
**BRASS**  
**B22**  
 H-34cm  
 W-30cm



**3000037**  
**SHEFFIELD**  
**10"**  
**B/F**  
**BRASS**  
**B22**  
 H-28cm  
 W-25cm



**3000047**  
**SHEFFIELD**  
**8"**  
**B/F**  
**BRASS**  
**B22**  
 H-22cm  
 W-20cm



**3000032**  
**SHEFFIELD**  
**6"**  
**B/F**  
**BRASS**  
**B22**  
 H-17cm  
 W-15cm

**NOTE -**  
 HALF  
 METER  
 1/2" & 3/4"  
 ROD  
 &  
 JOINER  
 EXTENSIONS  
 AVAILABLE



**3000281**  
**SHEFFIELD**  
**12"**  
**ROD PND**  
**3/4" x 1/2MT**  
**BRASS**  
**B22**  
 H-86cm (ADJ)  
 W-30cm



**3000245**  
**SHEFFIELD**  
**10"**  
**ROD PND**  
**1/2" x 1/2MT**  
**BRASS**  
**B22**  
 H-80cm (ADJ)  
 W-25cm



**3000258**  
**SHEFFIELD**  
**8"**  
**ROD PND**  
**1/2" x 1/2MT**  
**BRASS**  
**B22**  
 H-74cm (ADJ)  
 W-20cm



**3001191**  
**SHEFFIELD**  
**10"**  
**SINGLE**  
**CHAIN**  
**SUSP**  
**BROWN**  
**CORD**  
**BRASS B22**  
 H-100cm +(ADJ)  
 W-25cm

**NOTE -**  
 CHAIN SET & SUSPENSIONS  
 ARE  
 SUPPLIED IN A 1 METER DROP.

**- Brass Range -**

**Metal Shade Range**



**3000132**

**EDWARDIAN 390mm WHITE**

**ROD PND 1/2"x 1/2MT BRASS B22**

**NOTE -  
HALF METER 1/2" & 3/4" ROD & JOINER EXTENSIONS AVAILABLE**



**3000126**

**EDWARDIAN 390mm WHITE B/F BRASS B22**



**3000123**

**EDWARDIAN 250mm WHITE B/F BRASS B22**



**NOTE -  
HALF METER 1/2" & 3/4" ROD & JOINER EXTENSIONS AVAILABLE**

**3000131**

**EDWARDIAN 390mm WHITE**

**- CLOTH BROWN CORD SUSP BRASS B22**

**\* NOTE \*  
ALL METAL SHADES ARE POWDER COATED COLOURS WITH A WHITE INNER**

**3000185**

**EDWARDIAN 250mm WHITE LUKE 1/LT W/B BRASS B22**

**H - 25cm W - 25cm P - 32cm**



**Edwardian Range**



**3000128**

**EDWARDIAN 390mm BLACK**

**ROD PND 1/2"x 1/2MT BRASS B22**

**NOTE -  
HALF METER 1/2" & 3/4" ROD & JOINER EXTENSIONS AVAILABLE**



**3000124**

**EDWARDIAN 390mm BLACK B/F BRASS B22**



**3000121**

**EDWARDIAN 250mm BLACK B/F BRASS B22**



**NOTE - CLOTH CORD SET SUSPENSIONS ARE SUPPLIED IN A 1 METER DROP.**

**3000127**

**EDWARDIAN 390mm BLACK**

**- CLOTH BROWN CORD SUSP BRASS B22**

**3000183**

**EDWARDIAN 250mm BLACK LUKE 1/LT W/B BRASS B22**

**H - 25cm W - 25cm P - 32cm**



**- Brass Range -**

***Metal Shade Range***

**NOTE -**  
HALF  
METER  
1/2" & 3/4"  
ROD  
&  
JOINER  
EXTENSIONS  
AVAILABLE

**3000277**  
WAREHOUSE  
300mm  
WHITE  
-  
ROD PND  
1/2"x 1/2MT  
BRASS  
B22

**3000107**  
WAREHOUSE  
300mm  
WHITE  
-  
CLOTH  
BROWN  
CORD SUSP  
BRASS  
B22

**NOTE -**  
CLOTH CORD  
SET  
SUSPENSIONS  
ARE  
SUPPLIED  
IN  
A  
1 METER  
DROP.

**3000292**  
WAREHOUSE  
420mm WHITE  
-  
ROD PND  
3/4"x 1/2MT  
BRASS  
B22

**3000110**  
WAREHOUSE  
420mm WHITE  
-  
CLOTH BROWN  
CORD SUSP  
BRASS B22



***Warehouse Range***

**3000331**  
WAREHOUSE 300mm  
WHITE B/F BRASS B22

**\* NOTE \***  
ALL METAL  
SHADES ARE  
POWDER COATED  
COLOURS WITH A  
WHITE INNER

**NOTE -**  
HALF  
METER  
1/2" & 3/4"  
ROD  
&  
JOINER  
EXTENSIONS  
AVAILABLE

**3000275**  
WAREHOUSE  
300mm  
BLACK  
-  
ROD PND  
1/2"x 1/2MT  
BRASS  
B22

**3000105**  
WAREHOUSE  
300mm  
BLACK  
-  
CLOTH  
BROWN  
CORD SUSP  
BRASS  
B22

**NOTE -**  
CLOTH CORD  
SET  
SUSPENSIONS  
ARE  
SUPPLIED  
IN  
A  
1 METER  
DROP.

**3000290**  
WAREHOUSE  
420mm BLACK  
-  
ROD PND  
3/4"x 1/2MT  
BRASS  
B22

**3000108**  
WAREHOUSE  
420mm BLACK  
-  
CLOTH BROWN  
CORD SUSP  
BRASS B22

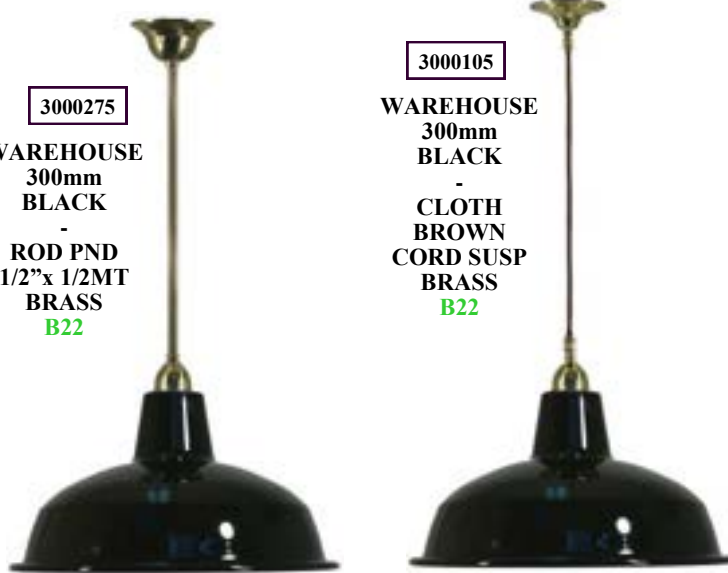

**3000329**  
WAREHOUSE 300mm  
BLACK B/F BRASS B22

**- Chrome Range -**

**Accessories  
In  
Chrome**



**2 1/4" GALLERY  
CHROME-29mm HOLE** 3016021



**3 1/4" GALLERY  
CHROME-29mm HOLE** 3016022



**4 1/4" GALLERY  
CHROME-29mm HOLE** 3016023



**6 1/4" GALLERY  
CHROME-29mm HOLE** 3016024



**8 1/4" GALLERY  
CHROME-29mm HOLE** 3016025



**12 1/4" GALLERY  
CHROME-29mm HOLE** 3016020



3016005  
**BATTEN COVER  
CHROME**  
29mm HOLE

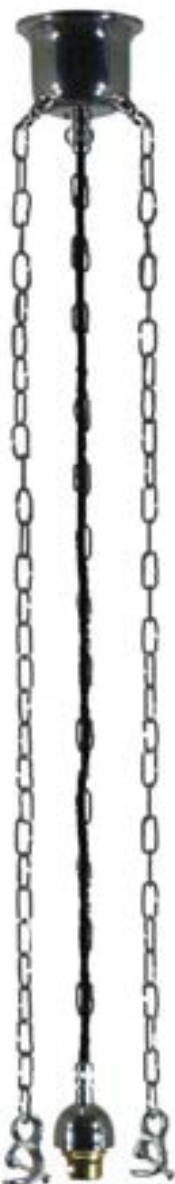

3016001  
**3 CHAIN SUSP  
BLACK CORD  
W-HOOKS 1 MT  
CHROME**  
B22

3016036  
**ROD  
SET  
3/4"  
x  
1/2MT  
CHROME**  
B22

3016028  
**ROD  
&  
JOINER  
3/4"  
x  
1/2MT  
CHROME**

3016034  
**ROD  
SET  
1/2"  
x  
1/2MT  
CHROME**  
B22

3016026  
**ROD  
&  
JOINER  
1/2"  
x  
1/2MT  
CHROME**

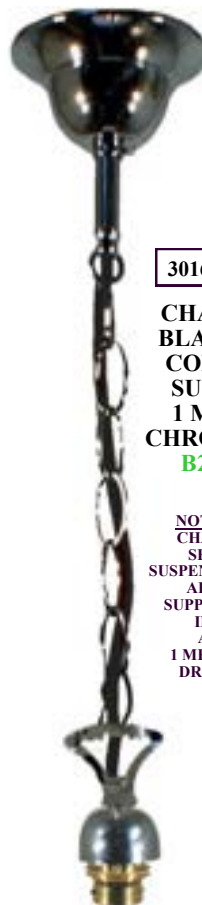

3016006  
**CHAIN  
BLACK  
CORD  
SUSP  
1 MT  
CHROME**  
B22

NOTE -  
CHAIN  
SET  
SUSPENSIONS  
ARE  
SUPPLIED  
IN  
A  
1 METER  
DROP.

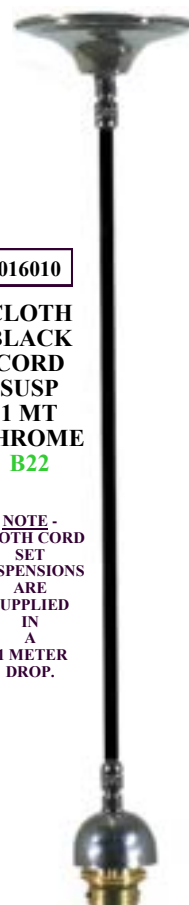

3016010  
**CLOTH  
BLACK  
CORD  
SUSP  
1 MT  
CHROME**  
B22

NOTE -  
CLOTH CORD  
SET  
SUSPENSIONS  
ARE  
SUPPLIED  
IN  
A  
1 METER  
DROP.

**- Chrome Range -**

**Wall  
Bracket  
Range**

*\* Wall Brackets  
Can Be  
Installed  
Either  
Facing Up  
Or  
Facing Down*



**3010213**  
**7011**  
**WALL SCONCE**  
**CHROME B22**  
H-33cm W-15cm  
P-10cm



**3010018**  
**CLAREDON 6"**  
**B/F CHROME B22**  
H-20cm W-15cm



**3010116**  
**LOXTON 1/LT W/B**  
**DECATRON OPAL MATT**  
**CHROME B22**  
H - 22cm W - 12cm P - 21cm



**3010219**

**WAUBRA 1/LT W/B CHROME**  
**CONO OPAL MATT B22**  
H-20cm W-14cm P-19cm



**3010218**

**WAUBRA 1/LT W/B CHROME**  
**CONO CLEAR B22**  
H-20cm W-14cm P-19cm



**3010107**

**KOSCINA 1/LT W/B CHROME**  
**CONO OPAL MATT B22**  
H-20cm W-14cm P-16cm



**3010106**

**KOSCINA 1/LT W/B CHROME**  
**CONO CLEAR B22**  
H-20cm W-14cm P-16cm



**3010217**

**WAUBRA 1/LT W/B CHROME**  
**DECATRON OPAL MATT B22**  
H - 19cm W - 12cm P - 18cm



**3010108**

**KOSCINA 1/LT W/B CHROME**  
**DECATRON OPAL MATT B22**  
H-19cm W-12cm P-16cm



**3010091**

**KLINE 1/LT W/B CHROME**  
**ZIPPER 23 FROST E27**  
H-22cm W-12cm P-16cm



**3010090**

**KLINE 1/LT W/B CHROME**  
**ZIPPER 23 CLEAR E27**  
H-22cm W-12cm P-16cm



**3010110**

**LOXTON 1/LT W/B CHROME**  
**CONO CLEAR B22**  
H - 22cm W - 14cm P - 22cm



**3010111**

**LOXTON 1/LT W/B CHROME**  
**CONO OPAL MATT B22**  
H - 22cm W - 14cm P - 22cm



**3010105**

**KOSCINA 1/LT W/B CHROME**  
**SPHERE 6" OPAL GLOSS B22**  
H - 26cm W - 15cm P - 16cm

**- Chrome Range -**

**ST Kilda  
Range**

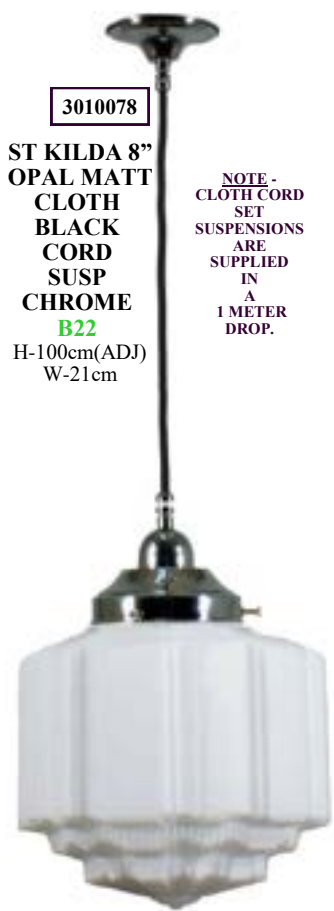

**3010078**

**ST KILDA 8" OPAL MATT CLOTH BLACK CORD SUSP CHROME B22**  
H-100cm(ADJ)  
W-21cm

**NOTE -**  
CLOTH CORD SET SUSPENSIONS ARE SUPPLIED IN A 1 METER DROP.



**3010072**

**ST KILDA 8" OPAL MATT SINGLE CHAIN BLACK CORD SUSP CHROME B22**  
H-100cm(ADJ)  
W-21cm

**NOTE -**  
CHAIN SET SUSPENSIONS ARE SUPPLIED IN A 1 METER DROP.



**3010185**

**ST KILDA 8" OPAL MATT ROD PND 1/2" x 1/2MT CHROME B22**  
H-73cm(ADJ)  
W-21cm



**3010199**

**ST KILDA 14" OPAL MATT ROD PND 3/4" x 1/2MT CHROME B22**  
H-75cm(ADJ)  
W-36cm

**NOTE -**  
HALF METER 1/2" & 3/4" ROD & JOINER EXTENSIONS AVAILABLE



**3010037**

**ST KILDA 8" OPAL MATT B/F CHROME B22**  
H-22cm W-21cm



**3010007**

**ST KILDA 14" OPAL MATT 3 CHAIN BLACK CORD SUSP CHROME B22**  
H-100cm (ADJ)  
W-34cm

**NOTE -**  
3 CHAIN SUSPENSION ARE SUPPLIED IN A 1 METER DROP WITH HOOKS



**3010014**

**ST KILDA 14" OPAL MATT B/F CHROME B22**  
H-29cm W-36cm

# - Chrome Range -

## *Senator Range*

**3010220**

**SENATOR 17"**  
**OPAL MATT**  
**3 CHAIN**  
**BLACK CORD**  
**SUSP**  
**CHROME B22**  
H-100cm (ADJ)  
W-42cm



NOTE -  
3 CHAIN  
SUSPENSION  
ARE  
SUPPLIED  
IN  
A  
1 METER  
DROP  
WITH  
HOOKS

**3010006**

**SENATOR 14"**  
**OPAL MATT**  
**3 CHAIN**  
**BLACK CORD**  
**SUSP**  
**CHROME B22**  
H-100cm (ADJ)  
W-34cm

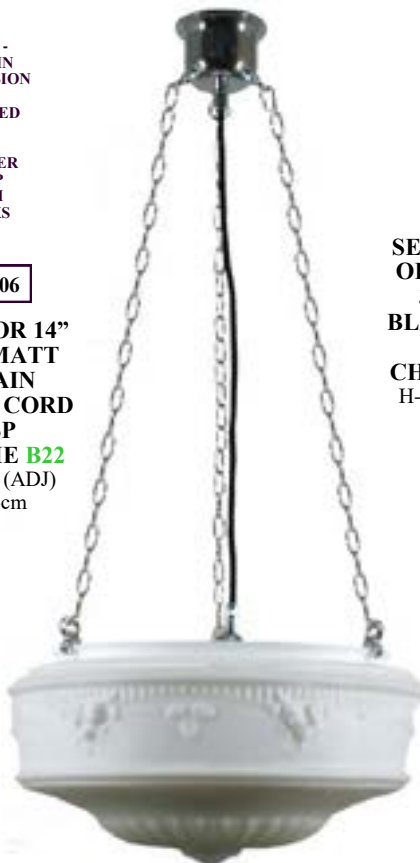

**3010004**

**SENATOR 11"**  
**OPAL MATT**  
**3 CHAIN**  
**BLACK CORD**  
**SUSP**  
**CHROME B22**  
H-100cm (ADJ)  
W-28cm



**3010181**

**SENATOR 8"**  
**OPAL MATT**  
**ROD PND**  
**1/2" x 1/2MT**  
**CHROME**  
**B22**  
H-75cm (ADJ)  
W-20cm

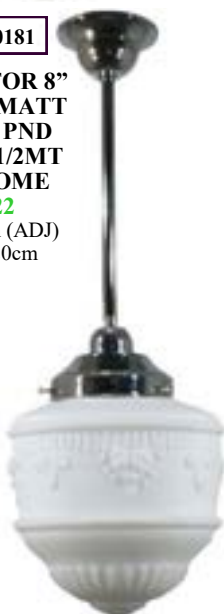

NOTE -  
CLOTH CORD  
SET  
SUSPENSIONS  
ARE  
SUPPLIED  
IN  
A  
1 METER  
DROP.

**3010222**

**SENATOR 8"**  
**OPAL MATT**  
**CLOTH**  
**BLACK CORD**  
**SUSP**  
**CHROME B22**  
H-100cm(ADJ)  
W-20cm



**3010015**

**SENATOR 14"OPAL MATT**  
**B/F CHROME B22**  
H-32cm W-36cm



NOTE -  
HALF  
METER  
1/2" & 3/4"  
ROD  
&  
JOINER  
EXTENSIONS  
AVAILABLE

**3010198**

**SENATOR 14"**  
**OPAL MATT**  
**ROD PND**  
**3/4" x 1/2MT**  
**CHROME B22**  
H-75cm(ADJ)  
W-36cm



**3010172**

**SENATOR 11"**  
**OPAL MATT**  
**ROD PND**  
**1/2" x 1/2MT**  
**CHROME B22**  
H-70cm(ADJ)  
W-28cm



NOTE -  
CHAIN  
SET  
SUSPENSIONS  
ARE  
SUPPLIED  
IN  
A  
1 METER  
DROP.

**3010221**

**SENATOR 8"**  
**OPAL**  
**MATT**  
**SINGLE**  
**CHAIN**  
**BLACK**  
**CORD**  
**SUSP**  
**CHROME**  
**B22**  
H-100cm(ADJ)  
W-20cm

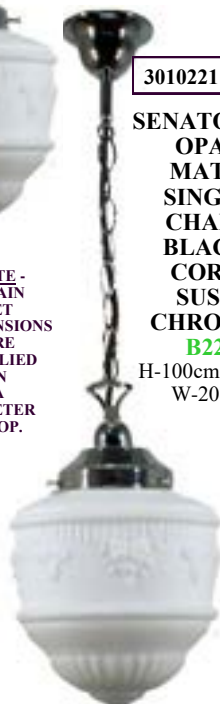

**3010047**

**SENATOR 11" OPAL MATT**  
**B/F CHROME B22**  
H-28cm W-28cm



**3010034**

**SENATOR 8" OPAL MATT**  
**B/F CHROME B22**  
H-23cm W-20cm



**- Chrome Range -**

**Empire  
Range**

NOTE -  
CLOTH CORD  
SET  
SUSPENSIONS  
ARE  
SUPPLIED  
IN  
A  
1 METER  
DROP.



**3010224**

**EMPIRE 8" OPAL MATT CLOTH BLACK CORD SUSP CHROME B22**  
H-100cm(ADJ)  
W-20cm

NOTE -  
CHAIN  
SET  
SUSPENSIONS  
ARE  
SUPPLIED  
IN  
A  
1 METER  
DROP.



**3010223**

**EMPIRE 8" OPAL MATT SINGLE CHAIN BLACK CORD SUSP CHROME B22**  
H-100cm(ADJ)  
W-20cm

**3010180**

**EMPIRE 8" OPAL MATT ROD PND 1/2" x 1/2MT CHROME B22**  
H-100cm (ADJ)  
W-20cm



NOTE -  
HALF  
METER  
1/2" & 3/4"  
ROD  
&  
JOINER  
EXTENSIONS  
AVAILABLE

**3010197**

**EMPIRE 14" OPAL MATT ROD PND 3/4" x 1/2MT CHROME B22**  
H-100cm (ADJ)  
W-36cm



**3010032**

**EMPIRE 8" OPAL MATT B/F CHROME B22**  
H-27cm W-20cm



**3010005**

**EMPIRE 14" OPAL MATT 3 CHAIN BLACK CORD SUSP CHROME B22**  
H-100cm(ADJ)  
W-36cm

NOTE -  
3 CHAIN  
SUSPENSION  
ARE  
SUPPLIED  
IN  
A  
1 METER  
DROP  
WITH  
HOOKS



**3010013**

**EMPIRE 14" OPAL MATT B/F CHROME B22**  
H-25cm W-20cm





**- Chrome Range -**

**Premier  
Range**

**NOTE -**  
HALF  
METER  
1/2" & 3/4"  
ROD  
&  
JOINER  
EXTENSIONS  
AVAILABLE

**3010227**

**PREMIER 12" OPAL MATT  
ROD PND  
3/4" x 1/2MT  
CHROME B22**  
H-80cm(ADJ)  
W-30cm



**NOTE -**  
CLOTH CORD  
SET  
SUSPENSIONS  
ARE  
SUPPLIED  
IN  
A  
1 METER  
DROP.

**3010230**

**PREMIER 8" OPAL MATT  
CLOTH  
BLACK  
CORD  
SUSP  
CHROME B22**  
H-100cm(ADJ)  
W-23cm



**3010228**

**PREMIER 8" OPAL MATT  
ROD PND  
1/2" x 1/2MT  
CHROME B22**  
H-75cm(ADJ)  
W-23cm



**NOTE -**  
CHAIN  
SET  
SUSPENSIONS  
ARE  
SUPPLIED  
IN  
A  
1 METER  
DROP.

**3010231**

**PREMIER 8" OPAL MATT  
SINGLE  
CHAIN  
BLACK  
CORD  
SUSP  
CHROME B22**  
H-100cm(ADJ)  
W-23cm

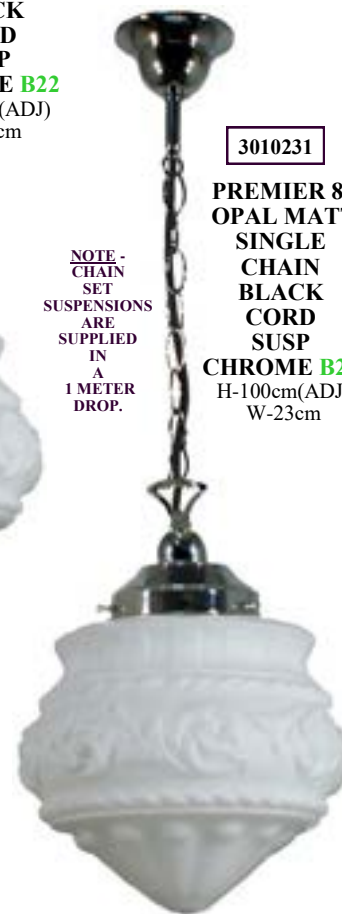

**NOTE -**  
3 CHAIN  
SUSPENSION  
ARE  
SUPPLIED  
IN  
A  
1 METER  
DROP  
WITH  
HOOKS

**3010225**

**PREMIER 12" OPAL MATT  
3 CHAIN  
BLACK CORD  
SUSP  
CHROME B22**  
H-100cm(ADJ)  
W-30cm



**3010229**

**PREMIER 8" OPAL MATT  
B/F CHROME B22**  
H-23cm W-23cm



**3010226**

**PREMIER 12" OPAL MATT  
B/F CHROME B22**  
H-32cm W-30cm



**- Chrome Range -**

**R/S  
& B/F  
Range**

**3010200**

**VICTORIAN 16" SCHOOLHOUSE OPAL MATT ROD PND 3/4" x 1/2MT CHROME B22**  
H-85cm(ADJ)  
W-40cm

**NOTE -**  
HALF METER 1/2" & 3/4" ROD & JOINER EXTENSIONS AVAILABLE

**3010177**

**VICTORIAN 12" SCHOOLHOUSE OPAL MATT ROD PND 1/2" x 1/2MT CHROME B22**  
H-75cm(ADJ)  
W-30cm

**3010189**

**VICTORIAN 9" SCHOOLHOUSE OPAL MATT ROD PND 1/2" x 1/2MT CHROME B22**  
H-70cm(ADJ)  
W-23cm

**3010041**

**VICTORIAN 9" SCHOOLHOUSE OPAL MATT B/F CHROME B22**  
H-19cm W-23cm

**3010028**

**VICTORIAN 12" SCHOOLHOUSE OPAL MATT B/F CHROME B22**  
H-23cm W-30cm

**3010202**

**LINCOLN SCHOOLHOUSE OPAL MATT ROD PND 3/4" x 1/2MT CHROME B22**  
H-85cm (ADJ)  
W-36cm

**NOTE -**  
HALF METER 1/2" & 3/4" ROD & JOINER EXTENSIONS AVAILABLE

**3010232**

**VICTORIAN 16" SCHOOLHOUSE OPAL MATT B/F CHROME B22**  
H-30cm W-40cm

**New  
Opal  
Matt**

**3010046**

**LINCOLN SCHOOLHOUSE OPAL MATT B/F CHROME B22**  
H-27cm W-36cm



**- Chrome Range -**

**R/S  
& B/F  
Range**

**New  
Opal  
Matt**

**3010201**

**BERGERAC  
OPAL MATT  
ROD PND  
3/4" x 1/2MT  
CHROME B22  
H-94cm (ADJ)  
W-26cm**

**NOTE -  
HALF  
METER  
1/2" & 3/4"  
ROD  
&  
JOINER  
EXTENSIONS  
AVAILABLE**

**3010044**

**DETROIT 14"  
OPAL MATT  
B/F CHROME B22  
H-28cm W-34cm**



**3010179**

**DETROIT 8"  
OPAL MATT  
ROD PND  
1/2" x 1/2MT  
CHROME B22  
H-72cm(ADJ)  
W-20cm**



**3010030**

**DETROIT 8"  
OPAL MATT  
B/F CHROME B22  
H-24cm W-20cm**



**3010196**

**DETROIT 14"  
OPAL MATT  
ROD PND  
3/4" x 1/2MT  
CHROME B22  
H-78cm(ADJ)  
W-34cm**



**3010193**

**MOULINS  
OPAL MATT  
ROD PND  
1/2" x 1/2MT  
CHROME B22  
H-70cm(ADJ)  
W-30cm**



**3010191**

**CHATEAU  
OPAL MATT  
ROD PND  
1/2" x 1/2MT  
CHROME B22  
H-70cm(ADJ)  
W-30cm**



**3010042**

**MOULINS  
OPAL MATT  
B/F CHROME B22  
H-21cm W-30cm**

**3010045**

**CHATEAU  
OPAL MATT  
B/F CHROME B22  
H-21cm W-30cm**

**- Chrome Range -**

**R/S  
& B/F  
Range**

**3010188**  
DERBY 9"  
OPAL  
MATT  
ROD PND  
1/2" x 1/2MT  
CHROME  
B22  
H-75cm(ADJ)  
W-23cm



**3010039**  
DERBY 9"  
OPAL MATT  
B/F CHROME  
B22  
H-25cm  
W-23cm



**3010195**  
DERBY 13"  
OPAL MATT  
ROD PND  
3/4" x 1/2MT  
CHROME  
B22  
H-80cm(ADJ)  
W-33cm



**3010043**  
DERBY 13"  
OPAL MATT  
B/F CHROME B22  
H-30cm W-33cm



**3010190**  
CANNES  
OPAL MATT  
ROD PND  
1/2" x 1/2MT  
CHROME  
B22  
H-70cm(ADJ)  
W-22cm

**3010029**  
CANNES  
OPAL MATT  
B/F CHROME B22  
H-19cm W-22cm



**NOTE -**  
HALF  
METER  
1/2" & 3/4"  
ROD  
&  
JOINER  
EXTENSIONS  
AVAILABLE

**3010031**  
DOME C  
OPAL MATT  
B/F CHROME B22  
H-21cm W-20cm



**3010192**  
DOME C OPAL MATT  
ROD PND 1/2" x 1/2MT  
CHROME B22  
H-70cm(ADJ) W-20cm

**3010026**  
BEEHIVE 10"  
OPAL MATT  
B/F CHROME B22  
H-22cm W-25cm

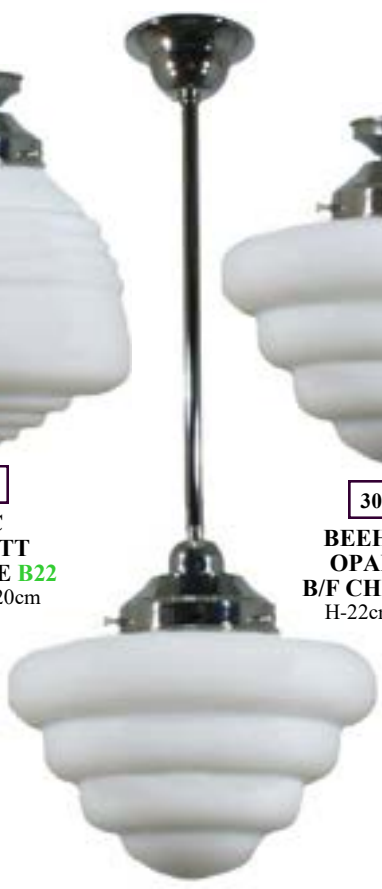

**3010171**  
BEEHIVE 10" OPAL MATT  
ROD PND 1/2" x 1/2MT CHROME B22  
H-70cm (ADJ) W-25cm

**3010040**  
PARKVILLE 9"  
OPAL MATT  
B/F CHROME B22  
H-21cm W-23cm



**3010233**  
PARKVILLE 9" OPAL MATT  
ROD PND 1/2" x 1/2MT  
CHROME B22  
H-68cm(ADJ) W-23cm

**New  
Opal  
Matt**

# - Chrome Range -



**3010234**  
**SPHERE**  
**12"**  
**OPAL**  
**GLOSS**  
**B/F**  
**CHROME**  
**B22**  
 H-34cm  
 W-30cm



**3010027**  
**SPHERE**  
**10"**  
**OPAL**  
**GLOSS**  
**B/F**  
**CHROME**  
**B22**  
 H-28cm  
 W-25cm



**3010033**  
**SPHERE**  
**8"**  
**OPAL**  
**GLOSS**  
**B/F**  
**CHROME**  
**B22**  
 H-22cm  
 W-20cm



**3010024**  
**SPHERE**  
**6"**  
**OPAL**  
**GLOSS**  
**B/F**  
**CHROME**  
**B22**  
 H-17cm  
 W-15cm

**NOTE -**  
 HALF  
 METER  
 1/2" & 3/4"  
 ROD  
 &  
 JOINER  
 EXTENSIONS  
 AVAILABLE



**3010194**  
**SPHERE 12"**  
**OPAL**  
**GLOSS**  
**ROD PND**  
**3/4" x 1/2MT**  
**CHROME**  
**B22**  
 H-86cm (ADJ)  
 W-30cm



**3010170**  
**SPHERE 10"**  
**OPAL**  
**GLOSS**  
**ROD PND**  
**1/2" x 1/2MT**  
**CHROME**  
**B22**  
 H-80cm (ADJ)  
 W-25cm



**3010178**  
**SPHERE 8"**  
**OPAL**  
**GLOSS**  
**ROD PND**  
**1/2" x 1/2MT**  
**CHROME**  
**B22**  
 H-74cm (ADJ)  
 W-20cm

**NOTE -**  
 CHAIN  
 SET  
 SUSPENSIONS  
 ARE  
 SUPPLIED  
 IN  
 A  
 1 METER  
 DROP.



**3010235**  
**SPHERE 10"**  
**OPAL**  
**GLOSS**  
**SINGLE**  
**CHAIN**  
**SUSP**  
**BROWN**  
**CORD**  
**CHROME**  
**B22**  
 H-100cm +(ADJ)  
 W-25cm



**3010237**  
**SHEFFIELD**  
**12"**  
**B/F**  
**CHROME**  
**B22**  
 H-34cm  
 W-30cm



**3010239**  
**SHEFFIELD**  
**10"**  
**B/F**  
**CHROME**  
**B22**  
 H-28cm  
 W-25cm



**3010241**  
**SHEFFIELD**  
**8"**  
**B/F**  
**CHROME**  
**B22**  
 H-22cm  
 W-20cm



**3010243**  
**SHEFFIELD**  
**6"**  
**B/F**  
**CHROME**  
**B22**  
 H-17cm  
 W-15cm

**NOTE -**  
 HALF  
 METER  
 1/2" & 3/4"  
 ROD  
 &  
 JOINER  
 EXTENSIONS  
 AVAILABLE



**3010236**  
**SHEFFIELD**  
**12"**  
**ROD PND**  
**3/4" x 1/2MT**  
**CHROME**  
**B22**  
 H-86cm (ADJ)  
 W-30cm



**3010238**  
**SHEFFIELD**  
**10"**  
**ROD PND**  
**1/2" x 1/2MT**  
**CHROME**  
**B22**  
 H-80cm (ADJ)  
 W-25cm



**3010240**  
**SHEFFIELD**  
**8"**  
**ROD PND**  
**1/2" x 1/2MT**  
**CHROME**  
**B22**  
 H-74cm (ADJ)  
 W-20cm



**3010242**  
**SHEFFIELD**  
**10"**  
**SINGLE**  
**CHAIN**  
**SUSP**  
**BROWN**  
**CORD**  
**CHROME** **B22**  
 H-100cm +(ADJ)  
 W-25cm

**NOTE -**  
 CHAIN SET & SUSPENSIONS  
 ARE  
 SUPPLIED IN A 1 METER DROP.

**- Chrome Range -**

**Paramount  
Range**



**1000705**

**PARAMOUNT W/  
LINCOLN  
SCHOOLHOUSE  
OPAL MATT  
1/LT PND  
CLEAR FLEX  
CHROME E27**  
FRAME SIZE  
WITH OUT CHAIN-  
1MT CHAIN SUPPLIED  
H-44cm(ADJ)  
W-36cm



**1000703**

**PARAMOUNT W/  
VICTORIAN 12"  
SCHOOLHOUSE  
OPAL MATT  
1/LT PND  
CLEAR FLEX  
CHROME E27**  
FRAME SIZE  
WITH OUT CHAIN-  
1MT CHAIN SUPPLIED  
H-41cm(ADJ)  
W-30cm



**1000702**

**PARAMOUNT W/  
VICTORIAN 9"  
SCHOOLHOUSE  
OPAL MATT  
1/LT PND  
CLEAR FLEX  
CHROME E27**  
FRAME SIZE  
WITH OUT CHAIN-  
1MT CHAIN SUPPLIED  
H-34cm(ADJ)  
W-23cm

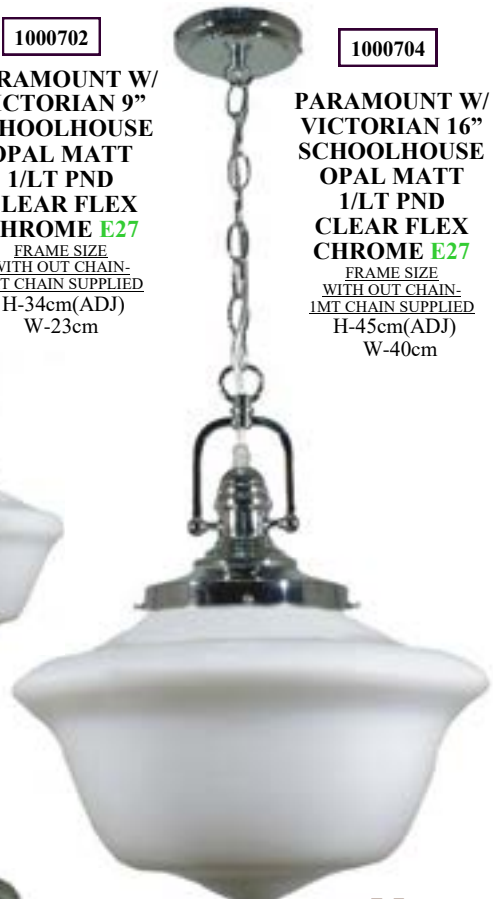

**1000704**

**PARAMOUNT W/  
VICTORIAN 16"  
SCHOOLHOUSE  
OPAL MATT  
1/LT PND  
CLEAR FLEX  
CHROME E27**  
FRAME SIZE  
WITH OUT CHAIN-  
1MT CHAIN SUPPLIED  
H-45cm(ADJ)  
W-40cm

**PARAMOUNT W/  
CHATEAU  
OPAL MATT  
1/LT PND  
CLEAR FLEX  
CHROME E27**  
FRAME SIZE  
WITH OUT CHAIN-  
1MT CHAIN SUPPLIED  
H-36cm(ADJ) W-30cm

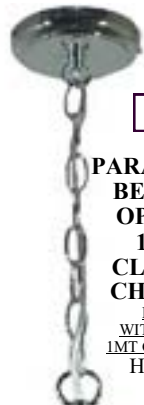

**1000390**

**PARAMOUNT W/  
BEEHIVE 10"  
OPAL MATT  
1/LT PND  
CLEAR FLEX  
CHROME E27**  
FRAME SIZE  
WITH OUT CHAIN-  
1MT CHAIN SUPPLIED  
H-37cm(ADJ)  
W-26cm

**New  
Opal  
Matt**



**1000700**

**PARAMOUNT W/  
MOULINS  
OPAL MATT  
1/LT PND  
CLEAR FLEX  
CHROME E27**  
FRAME SIZE  
WITH OUT CHAIN-  
1MT CHAIN SUPPLIED  
H-37cm(ADJ)  
W-30cm



**1000391**

**PARAMOUNT  
W/  
DOME C  
OPAL MATT  
1/LT PND  
CLEAR FLEX  
CHROME E27**  
FRAME SIZE  
WITH OUT CHAIN-  
1MT CHAIN SUPPLIED  
H-37cm(ADJ)  
W-20cm



**1000387**



**1000393**

**PARAMOUNT W/  
DETROIT 14"  
OPAL MATT  
1/LT PND CLEAR  
FLEX  
CHROME E27**  
FRAME SIZE  
WITH OUT CHAIN-  
1MT CHAIN SUPPLIED  
H-42cm(ADJ)  
W-35cm

**- Chrome Range -**

**Paramount  
Range**



**1000714**  
**PARAMOUNT  
 SPHERE 12"  
 OPAL GLOSS  
 1/LT PND  
 CLEAR FLEX  
 CHROME E27**  
 FRAME SIZE  
 WITH OUT CHAIN-  
 1MT CHAIN SUPPLIED  
 H-86cm (ADJ)  
 W-30cm



**1000713**  
**PARAMOUNT  
 SPHERE 10"  
 OPAL GLOSS  
 1/LT PND  
 CLEAR FLEX  
 CHROME E27**  
 FRAME SIZE  
 WITH OUT CHAIN-  
 1MT CHAIN SUPPLIED  
 H-80cm (ADJ)  
 W-25cm



**1000712**  
**PARAMOUNT  
 SPHERE 8"  
 OPAL GLOSS  
 1/LT PND  
 CLEAR FLEX  
 CHROME E27**  
 FRAME SIZE  
 WITH OUT CHAIN-  
 1MT CHAIN SUPPLIED  
 H-74cm (ADJ)  
 W-20cm



**1000711**  
**PARAMOUNT  
 PARKVILLE 9"  
 OPAL MATT  
 1/LT PND  
 CLEAR FLEX  
 CHROME E27**  
 FRAME SIZE  
 WITH OUT CHAIN-  
 1MT CHAIN SUPPLIED  
 H-68cm (ADJ)  
 W-23cm



**1000715**  
**PARAMOUNT  
 ST KILDA 8"  
 OPAL MATT  
 1/LT PND  
 CLEAR FLEX  
 CHROME E27**  
 FRAME SIZE  
 WITH OUT CHAIN-  
 1MT CHAIN SUPPLIED  
 H-73cm (ADJ)  
 W-21cm



**1000716**  
**PARAMOUNT  
 ST KILDA 14"  
 OPAL MATT  
 1/LT PND  
 CLEAR FLEX  
 CHROME E27**  
 FRAME SIZE  
 WITH OUT CHAIN-  
 1MT CHAIN SUPPLIED  
 H-75cm (ADJ)  
 W-36cm



**1000710**  
**PARAMOUNT  
 DERBY 13"  
 OPAL MATT  
 1/LT PND  
 CLEAR FLEX  
 CHROME E27**  
 FRAME SIZE  
 WITH OUT CHAIN-  
 1MT CHAIN SUPPLIED  
 H-80cm (ADJ)  
 W-30cm

**- Patina Black Range -**

***Accessories  
In  
Patina Black***



**2 1/4" GALLERY  
PATINA BLK-29mm HOLE**

**3026022**



**3 1/4" GALLERY  
PATINA BLK-29mm HOLE**

**3026023**



**4 1/4" GALLERY  
PATINA BLK-29mm HOLE**

**3026024**



**6 1/4" GALLERY  
PATINA BLK-29mm HOLE**

**3026025**



**8 1/4" GALLERY  
PATINA BLK-29mm HOLE**

**3026026**



**12 1/4" GALLERY  
PATINA BLK-29mm HOLE**

**3026021**



**3026004**

**BATTEN COVER  
PATINA BLK-29mm HOLE**



**3026001**

**3 CHAIN SUSP  
BLACK CORD  
W-HOOKS 1 MT  
PATINA BLK  
B22**

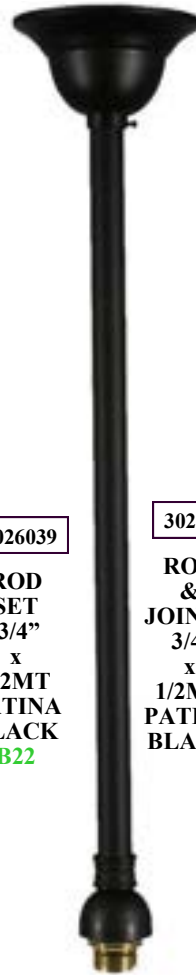

**3026039**

**ROD  
SET  
3/4"  
x  
1/2MT  
PATINA  
BLACK  
B22**

**3026032**

**ROD  
&  
JOINER  
3/4"  
x  
1/2MT  
PATINA  
BLACK**



**3026037**

**ROD  
SET  
1/2"  
x  
1/2MT  
PATINA  
BLACK  
B22**



**3026031**

**ROD  
&  
JOINER  
1/2"  
x  
1/2MT  
PATINA  
BLACK**



**3026009**

**CLOTH  
BLACK  
CORD  
SUSP  
1 MT  
PATINA  
BLACK  
B22**

**NOTE -  
CHAIN  
SET  
SUSPENSIONS  
ARE  
SUPPLIED  
IN  
A  
1 METER  
DROP.**

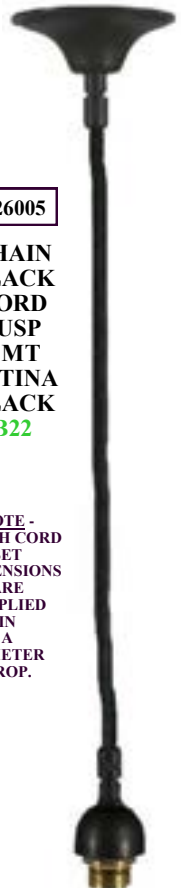

**3026005**

**CHAIN  
BLACK  
CORD  
SUSP  
1 MT  
PATINA  
BLACK  
B22**

**NOTE -  
CLOTH CORD  
SET  
SUSPENSIONS  
ARE  
SUPPLIED  
IN  
A  
1 METER  
DROP.**



**- Patina Black Range -**

***Wall  
Bracket  
Range***

***\* Wall Brackets  
Can Be Installed Either  
Facing Up  
Or  
Facing Down***



3020145

**KOSCINA 1/LT W/B CLAREDON SMALL  
PATINA BLK B22**  
H-20cm W-16cm P-16cm



3020078

**CLAREDON 6"  
B/F PATINA BLK B22**  
H-20cm W-15cm



3020143

**KOSCINA 1/LT W/B CONO OPAL MATT  
PATINA BLK B22**  
H-20cm W-14cm P-16cm



3020142

**KOSCINA 1/LT W/B CONO CLEAR  
PATINA BLK B22**  
H-20cm W-14cm P-16cm



3020148

**KOSCINA 1/LT W/B ZIPPER 23 FROST  
PATINA BLK B22**  
H-22cm W-12cm P-16cm



3020147

**KOSCINA 1/LT W/B ZIPPER 23 CLEAR  
PATINA BLK B22**  
H-22cm W-12cm P-16cm



3020144

**KOSCINA 1/LT W/B DECATRON OPAL MATT  
PATINA BLK B22**  
H-19cm W-12cm P-16cm



3020146

**KOSCINA 1/LT W/B SPHERE 6" OPAL GLOSS  
PATINA BLK B22**  
H-26cm W-15cm P-16cm



**- Patina Black Range -**

**ST Kilda  
Range**

**3020067**

**ST KILDA 8" OPAL MATT CLOTH BLACK CORD SUSP PATINA BLK**

**B22**  
H-100cm(ADJ)  
W-21cm

**NOTE -**  
CLOTH CORD SET SUSPENSIONS ARE SUPPLIED IN A 1 METER DROP.



**3020057**

**ST KILDA 8" OPAL MATT SINGLE CHAIN BLACK CORD SUSP PATINA BLK**

**B22**  
H-100cm(ADJ)  
W-21cm

**NOTE -**  
CHAIN SET SUSPENSIONS ARE SUPPLIED IN A 1 METER DROP.



**3020122**

**ST KILDA 8" OPAL MATT ROD PND 1/2" x 1/2MT PATINA BLK**

**B22**  
H-73cm(ADJ)  
W-21cm



**NOTE -**

HALF METER 1/2" & 3/4" ROD & JOINER EXTENSIONS AVAILABLE

**3020113**

**ST KILDA 14" OPAL MATT ROD PND 3/4" x 1/2MT PATINA BLK**

**B22**  
H-75cm(ADJ)  
W-36cm



**3020032**

**ST KILDA 8" OPAL MATT B/F PATINA BLK**

**B22**  
H-22cm W-21cm



**3020007**

**ST KILDA 14" OPAL MATT 3 CHAIN BLACK CORD SUSP PATINA BLK**

**B22**  
H-100cm (ADJ)  
W-34cm

**NOTE -**  
3 CHAIN SUSPENSION ARE SUPPLIED IN A 1 METER DROP WITH HOOKS



**3020010**

**ST KILDA 14" OPAL MATT B/F PATINA BLK**

**B22**  
H-29cm W-36cm



# - Patina Black Range -

## *Senator Range*

**3020134**

**SENATOR 17" OPAL MATT  
3 CHAIN  
BLACK CORD  
SUSP  
PATINA BLK**

**B22**  
H-100cm (ADJ)  
W-42cm

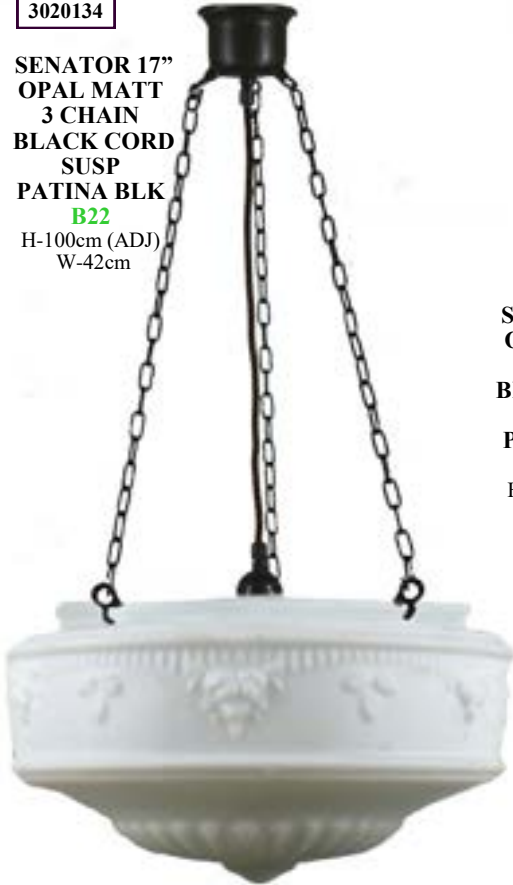

NOTE -  
3 CHAIN  
SUSPENSION  
ARE  
SUPPLIED  
IN  
A  
1 METER  
DROP  
WITH  
HOOKS

**3020006**

**SENATOR 14" OPAL MATT  
3 CHAIN  
BLACK CORD  
SUSP  
PATINA BLK**

**B22**  
H-100cm (ADJ)  
W-34cm

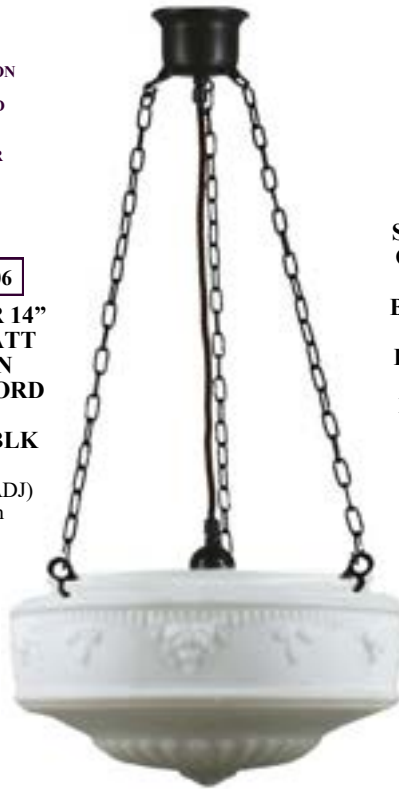

**3020004**

**SENATOR 11" OPAL MATT  
3 CHAIN  
BLACK CORD  
SUSP  
PATINA BLK**

**B22**  
H-100cm (ADJ)  
W-28cm



**3020120**

**SENATOR 8" OPAL MATT  
ROD PND  
1/2" x 1/2MT  
PATINA BLK**

**B22**  
H-75cm (ADJ)  
W-20cm



NOTE -  
CLOTH CORD  
SET  
SUSPENSIONS  
ARE  
SUPPLIED  
IN  
A  
1 METER  
DROP.

**3020059**

**SENATOR 8" OPAL MATT  
CLOTH  
BLACK  
CORD SUSP  
PATINA BLK**

**B22**  
H-100cm(ADJ)  
W-20cm



**3020009**

**SENATOR 14" OPAL MATT  
B/F PATINA BLK **B22****  
H-32cm W-36cm



NOTE -

HALF  
METER  
1/2" & 3/4"  
ROD  
&  
JOINER  
EXTENSIONS  
AVAILABLE

**3020112**

**SENATOR 14" OPAL MATT  
ROD PND  
3/4" x 1/2MT  
PATINA BLK**

**B22**  
H-75cm(ADJ)  
W-36cm



**3020102**

**SENATOR 11" OPAL MATT  
ROD PND  
1/2" x 1/2MT  
PATINA BLK**

**B22**  
H-70cm(ADJ)  
W-28cm



NOTE -  
CHAIN  
SET  
SUSPENSIONS  
ARE  
SUPPLIED  
IN  
A  
1 METER  
DROP.

**3020052**

**SENATOR  
8" OPAL  
MATT  
SINGLE  
CHAIN  
BLACK  
CORD SUSP  
PATINA  
BLK**

**B22**  
H-100cm(ADJ)  
W-20cm



**3020043**

**SENATOR 11" OPAL MATT  
B/F PATINA BLK **B22****  
H-28cm W-28cm



**3020029**

**SENATOR 8" OPAL MATT  
B/F PATINA BLK **B22****  
H-23cm W-20cm



**- Patina Black Range -**

**Empire  
Range**



NOTE -  
CLOTH CORD  
SET  
SUSPENSIONS  
ARE  
SUPPLIED  
IN  
A  
1 METER  
DROP.

**3020069**

**EMPIRE 8" OPAL MATT CLOTH BLACK CORD SUSP PATINA BLK**  
B22  
H-100cm(ADJ)  
W-20cm

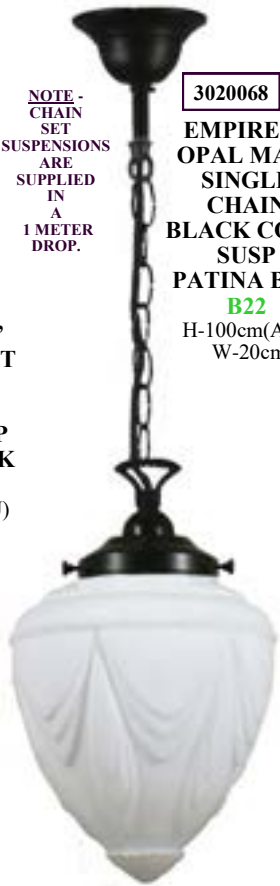

NOTE -  
CHAIN  
SET  
SUSPENSIONS  
ARE  
SUPPLIED  
IN  
A  
1 METER  
DROP.

**3020068**

**EMPIRE 8" OPAL MATT SINGLE CHAIN BLACK CORD SUSP PATINA BLK**  
B22  
H-100cm(ADJ)  
W-20cm



**3020118**

**EMPIRE 8" OPAL MATT ROD PND 1/2" x 1/2MT PATINA BLK**  
B22  
H-100cm (ADJ)  
W-20cm



NOTE -  
HALF  
METER  
1/2" & 3/4"  
ROD  
&  
JOINER  
EXTENSIONS  
AVAILABLE

**3020111**

**EMPIRE 14" OPAL MATT ROD PND 3/4" x 1/2MT PATINA BLK**  
B22  
H-100cm(ADJ)  
W-36cm



**3020026**

**EMPIRE 8" OPAL MATT B/F PATINA BLK** B22  
H-27cm W-20cm



NOTE -  
3 CHAIN  
SUSPENSION  
ARE  
SUPPLIED  
IN  
A  
1 METER  
DROP  
WITH  
HOOKS

**3020005**

**EMPIRE 14" OPAL MATT 3 CHAIN SUSP PATINA BLK**  
B22  
H-100cm(ADJ)  
W-36cm



**3020008**

**EMPIRE 14" OPAL MATT B/F PATINA BLK** B22  
H-25cm W-36cm

**- Patina Black Range -**

**Premier  
Range**

**NOTE -**  
HALF  
METER  
1/2" & 3/4"  
ROD  
&  
JOINER  
EXTENSIONS  
AVAILABLE



**3020107**

**PREMIER 12"  
OPAL MATT  
ROD PND  
3/4" x 1/2MT  
PATINA BLK  
B22**  
H-80cm(ADJ)  
W-30cm

**NOTE -**  
CLOTH CORD  
SET  
SUSPENSIONS  
ARE  
SUPPLIED  
IN  
A  
1 METER  
DROP.



**3020135**

**PREMIER 8"  
OPAL MATT  
CLOTH  
BLACK CORD  
SUSP  
PATINA BLK  
B22**  
H-100cm(ADJ)  
W-23cm

**3020119**

**PREMIER 8"  
OPAL MATT  
ROD PND  
1/2" x 1/2MT  
PATINA BLK  
B22**  
H-75cm(ADJ)  
W-23cm



**3020136**

**PREMIER 8"  
OPAL MATT  
SINGLE  
CHAIN  
BLACK CORD  
SUSP  
PATINA BLK  
B22**  
H-100cm(ADJ)  
W-23cm

**NOTE -**  
CHAIN  
SET  
SUSPENSIONS  
ARE  
SUPPLIED  
IN  
A  
1 METER  
DROP.



**NOTE -**  
3 CHAIN  
SUSPENSION  
ARE  
SUPPLIED  
IN  
A  
1 METER  
DROP  
WITH  
HOOKS



**3020070**

**PREMIER 12"  
OPAL MATT  
3 CHAIN  
BLACK CORD  
SUSP  
PATINA BLK  
B22**  
H-100cm(ADJ)  
W-30cm



**3020028**

**PREMIER 8"  
OPAL MATT  
B/F PATINA BLK  
B22**  
H-23cm W-23cm



**3020044**

**PREMIER 12"  
OPAL MATT  
B/F PATINA BLK B22**  
H-32cm W-30cm

# - Patina Black Range -

**3020015**

**SPHERE  
6"  
OPAL  
GLOSS  
B/F  
PATINA  
BLK B22**  
H-17cm  
W-15cm



**3020027**

**SPHERE  
8"  
OPAL  
GLOSS  
B/F  
PATINA  
BLK  
B22**  
H-22cm  
W-20cm



**3020020**

**SPHERE  
10"  
OPAL  
GLOSS  
B/F  
PATINA  
BLK  
B22**  
H-28cm  
W-25cm



**3020022**

**SPHERE  
12"  
OPAL  
GLOSS  
B/F  
PATINA  
BLK  
B22**  
H-34cm  
W-30cm



**3020055**

**SPHERE 10"  
OPAL  
GLOSS  
SINGLE  
CHAIN SUSP  
BROWN  
CORD  
PATINA BLK  
B22**  
H-100cm +(ADJ)  
W-25cm



**3020115**

**SPHERE 8"  
OPAL  
GLOSS  
ROD PND  
1/2" x 1/2MT  
PATINA BLK  
B22**  
H-74cm (ADJ)  
W-20cm



**3020099**

**SPHERE 10"  
OPAL  
GLOSS  
ROD PND  
1/2" x 1/2MT  
PATINA BLK  
B22**  
H-80cm (ADJ)  
W-25cm



**3020103**

**SPHERE 12"  
OPAL  
GLOSS  
ROD PND  
3/4" x 1/2MT  
PATINA BLK  
B22**  
H-86cm (ADJ)  
W-30cm



**NOTE -**  
HALF  
METER  
1/2" & 3/4"  
ROD  
&  
JOINER  
EXTENSIONS  
AVAILABLE

**NOTE -**  
CHAIN SET & SUSPENSIONS  
ARE  
SUPPLIED IN A 1 METER DROP.

**3020017**

**SHEFFIELD  
6"  
B/F  
PATINA  
BLK  
B22**  
H-17cm  
W-15cm



**3020030**

**SHEFFIELD  
8"  
B/F  
PATINA  
BLK  
B22**  
H-22cm  
W-20cm



**3020021**

**SHEFFIELD  
10"  
B/F  
PATINA  
BLK  
B22**  
H-28cm  
W-25cm



**3020023**

**SHEFFIELD  
12"  
B/F  
PATINA  
BLK  
B22**  
H-34cm  
W-30cm



**3020137**

**SHEFFIELD  
10"  
SINGLE  
CHAIN  
SUSP  
BROWN  
CORD  
PATINA BLK  
B22**  
H-100cm +(ADJ)  
W-25cm



**3020116**

**SHEFFIELD  
8"  
ROD PND  
1/2" x 1/2MT  
PATINA BLK  
B22**  
H-74cm (ADJ)  
W-20cm



**3020100**

**SHEFFIELD  
10"  
ROD PND  
1/2" x 1/2MT  
PATINA BLK  
B22**  
H-80cm (ADJ)  
W-25cm



**3020104**

**SHEFFIELD  
12"  
ROD PND  
3/4" x 1/2MT  
PATINA BLK  
B22**  
H-86cm (ADJ)  
W-30cm



**NOTE -**  
HALF  
METER  
1/2" & 3/4"  
ROD  
&  
JOINER  
EXTENSIONS  
AVAILABLE

**NOTE -**  
CHAIN SET & SUSPENSIONS  
ARE  
SUPPLIED IN A 1 METER DROP.

*- Patina Black Range -*

*R/S  
& B/F  
Range*

**3020114**

**VICTORIAN  
16"  
SCHOOLHOUSE  
OPAL MATT  
ROD PND  
3/4" x 1/2MT  
PATINA BLK  
B22  
H-85cm(ADJ)  
W-40cm**

**NOTE -  
HALF  
METER  
1/2" & 3/4"  
ROD  
&  
JOINER  
EXTENSIONS  
AVAILABLE**

**3020108**

**VICTORIAN  
12"  
SCHOOLHOUSE  
OPAL MATT  
ROD PND  
1/2" x 1/2MT  
PATINA BLK  
B22  
H-75cm(ADJ)  
W-30cm**

**3020127**

**VICTORIAN  
9"  
SCHOOLHOUSE  
OPAL MATT  
ROD PND  
1/2" x 1/2MT  
PATINA BLK  
B22  
H-70cm(ADJ)  
W-23cm**



**3020034**

**VICTORIAN 9" SCHOOLHOUSE  
OPAL MATT B/F PATINA BLK B22  
H-19cm W-23cm**

**3020024**

**VICTORIAN 12" SCHOOLHOUSE  
OPAL MATT  
B/F PATINA BLK B22  
H-23cm W-30cm**

**3020040**

**VICTORIAN 16" SCHOOLHOUSE  
OPAL MATT  
B/F PATINA BLK B22  
H-30cm W-40cm**

**NOTE -**

**HALF  
METER  
1/2" & 3/4"  
ROD  
&  
JOINER  
EXTENSIONS  
AVAILABLE**

**3020132**

**LINCOLN  
SCHOOLHOUSE  
OPAL MATT  
ROD PND  
3/4" x 1/2MT  
PATINA BLK  
B22  
H-85cm (ADJ)  
W-36cm**

*New  
Opal  
Matt*



**3020042**

**LINCOLN SCHOOLHOUSE  
OPAL MATT B/F PATINA BLK B22  
H-27cm W-36cm**



**- Patina Black Range -**

**R/S  
& B/F  
Range**

**New  
Opal  
Matt**



**3020110**

**DETROIT 14" OPAL MATT ROD PND**  
3/4" x 1/2MT  
PATINA BLK  
B22  
H-78cm(ADJ)  
W-34cm



**3020117**

**DETROIT 8" OPAL MATT ROD PND**  
1/2" x 1/2MT  
PATINA BLK  
B22  
H-72cm(ADJ)  
W-20cm



**3020039**

**DETROIT 14" OPAL MATT B/F PATINA BLK**  
B22  
H-28cm W-34cm



**3020025**

**DETROIT 8" OPAL MATT B/F PATINA BLK**  
B22  
H-24cm W-20cm



**3020128**

**BERGERAC OPAL MATT ROD PND**  
3/4" x 1/2MT  
PATINA BLK  
B22  
H-94cm (ADJ)  
W-26cm

**NOTE -**  
HALF METER  
1/2" & 3/4"  
ROD &  
JOINER  
EXTENSIONS  
AVAILABLE



**3020133**

**MOULINS OPAL MATT ROD PND**  
1/2" x 1/2MT  
PATINA BLK  
B22  
H-70cm(ADJ)  
W-30cm



**3020037**

**MOULINS OPAL MATT B/F PATINA BLK**  
B22  
H-21cm W-30cm



**3020130**

**CHATEAU OPAL MATT ROD PND**  
1/2" x 1/2MT  
PATINA BLK  
B22  
H-70cm(ADJ)  
W-28cm



**3020041**

**CHATEAU OPAL MATT B/F PATINA BLK**  
B22  
H-21cm W-30cm



**- Patina Black Range -**

**R/S  
& B/F  
Range**

**New  
Opal  
Matt**

**NOTE -**  
HALF  
METER  
1/2" & 3/4"  
ROD  
&  
JOINER  
EXTENSIONS  
AVAILABLE

**3020129**

**CANNES  
OPAL MATT  
ROD PND  
1/2" x 1/2MT  
PATINA BLK  
B22**  
H-70cm(ADJ)  
W-22cm



**3020038**

**DERBY 13"  
OPAL MATT B/F  
PATINA BLK B22**  
H-30cm W-33cm



**3020109**

**DERBY 13"  
OPAL MATT  
ROD PND  
3/4" x 1/2MT  
PATINA BLK  
B22**  
H-80cm(ADJ)  
W-33cm



**3020125**

**DERBY 9"  
OPAL MATT  
ROD PND  
1/2" x 1/2MT  
PATINA BLK  
B22**  
H-75cm(ADJ) W-23cm



**3020033**

**DERBY 9"  
OPAL MATT B/F  
PATINA BLK B22**  
H-25cm W-23cm



**3020035**

**CANNES  
OPAL MATT B/F  
PATINA BLK B22**  
H-19cm W-22cm



**3020131**

**DOMEC  
OPAL MATT  
ROD PND  
1/2" x 1/2MT  
PATINA BLK  
B22**  
H-70cm(ADJ)  
W-20cm



**3020036**

**DOMEC  
OPAL MATT B/F  
PATINA BLK B22**  
H-21cm W-20cm



**3020019**

**BEEHIVE 10"  
OPAL MATT B/F  
PATINA BLK B22**  
H-22cm W-25cm



**3020018**

**PARKVILLE 9"  
OPAL MATT B/F  
PATINA BLK B22**  
H-21cm W-23cm



**3020101**

**BEEHIVE 10" OPAL MATT  
ROD PND 1/2" x 1/2MT PATINA BLK B22**  
H-70cm (ADJ) W-25cm



**3020126**

**PARKVILLE 9" OPAL MATT  
ROD PND 1/2" x 1/2MT PATINA BLK B22**  
H-68cm(ADJ) W-23cm



***- Patina Black Range -***

***Paramount  
Range***

**1000699**

**PARAMOUNT  
LINCOLN  
SCHOOLHOUSE  
OPAL MATT  
1/LT PND  
BLACK FLEX  
PATINA BLK**

**E27**  
FRAME SIZE  
WITH OUT CHAIN-  
1MT CHAIN SUPPLIED  
H-44cm(ADJ)  
W-36cm



**1000389**

**PARAMOUNT  
VICTORIAN 12"™  
SCHOOLHOUSE  
OPAL MATT  
1/LT PND  
BLACK FLEX  
PATINA BLK**

**E27**  
FRAME SIZE  
WITH OUT CHAIN-  
1MT CHAIN SUPPLIED  
H-41cm(ADJ)  
W-30cm



**1000698**

**PARAMOUNT  
VICTORIAN 9"™  
SCHOOLHOUSE  
OPAL MATT  
1/LT PND  
BLACK FLEX  
PATINA BLK**

**E27**  
FRAME SIZE  
WITH OUT CHAIN-  
1MT CHAIN SUPPLIED  
H-34cm(ADJ)  
W-23cm



**1000680**

**PARAMOUNT  
VICTORIAN 16"™  
SCHOOLHOUSE  
OPAL MATT  
1/LT PND  
BLACK FLEX  
PATINA BLK**

**E27**  
FRAME SIZE  
WITH OUT CHAIN-  
1MT CHAIN SUPPLIED  
H-45cm(ADJ)  
W-40cm



**1000701**

**PARAMOUNT  
CHATEAU OPAL MATT  
1/LT PND  
BLACK FLEX  
PATINA BLK**

**E27**  
FRAME SIZE  
WITH OUT CHAIN-  
1MT CHAIN SUPPLIED  
H-36cm(ADJ) W-30cm



**1000697**

**PARAMOUNT  
ST KILDA 9"™  
OPAL MATT  
1/LT PND  
BLACK FLEX  
PATINA BLK**

**E27**  
FRAME SIZE  
WITH OUT CHAIN-  
1MT CHAIN SUPPLIED  
H-41cm(ADJ)  
W-21cm



**1000386**

**PARAMOUNT  
MOULINS  
OPAL MATT  
1/LT PND  
BLACK FLEX  
PATINA BLK**

**E27**  
FRAME SIZE  
WITH OUT CHAIN-  
1MT CHAIN SUPPLIED  
H-37cm(ADJ)  
W-30cm



**1000707**

**PARAMOUNT  
CANNES  
OPAL MATT  
1/LT PND  
BLACK FLEX  
PATINA BLK**

**E27**  
FRAME SIZE  
WITH OUT CHAIN-  
1MT CHAIN SUPPLIED  
H-38cm(ADJ)  
W-22cm



**1000392**

**PARAMOUNT  
DETROIT 14"™  
OPAL MATT  
1/LT PND  
BLACK FLEX  
PATINA BLK**

**E27**  
FRAME SIZE  
WITH OUT CHAIN-  
1MT CHAIN SUPPLIED  
H-42cm(ADJ)  
W-35cm



***New  
Opal  
Matt***

**- Patina Black Range -**

**Paramount  
Range**

**1000686**

**PARAMOUNT  
W/OPAL GLOSS  
12" SPHERE  
1/LT PND  
BLACK FLEX  
PATINA BLK**

**E27**

FRAME SIZE  
WITH OUT CHAIN  
1MT CHAIN SUPPLIED  
H-52cm(ADJ)  
W-30cm



**1000681**

**PARAMOUNT  
W/OPAL GLOSS  
10" SPHERE  
1/LT PND  
BLACK FLEX  
PATINA BLK**

**E27**

FRAME SIZE  
WITH OUT CHAIN  
1MT CHAIN SUPPLIED  
H-46cm(ADJ)  
W-25cm



**1000721**

**PARAMOUNT  
W/OPAL GLOSS  
8" SPHERE  
1/LT PND  
BLACK FLEX  
PATINA BLK**

**E27**

FRAME SIZE  
WITH OUT CHAIN  
1MT CHAIN SUPPLIED  
H-41cm(ADJ)  
W-20cm



**1000706**

**PARAMOUNT  
W/BEEHIVE  
OPAL MATT  
1/LT PND  
BLACK FLEX  
PATINA BLK**

**E27**

FRAME SIZE  
WITH OUT CHAIN  
1MT CHAIN SUPPLIED  
H-41cm(ADJ)  
W-25cm



**New  
Opal  
Matt**

**1000720**

**PARAMOUNT  
W/PARKVILLE 9"  
OPAL MATT  
1/LT PND  
BLACK FLEX  
PATINA BLK**

**E27**

FRAME SIZE  
WITH OUT CHAIN  
1MT CHAIN SUPPLIED  
H-40cm(ADJ)  
W-23cm



**1000719**

**PARAMOUNT  
W/DOME C  
OPAL MATT  
1/LT PND  
BLACK FLEX  
PATINA BLK**

**E27**

FRAME SIZE  
WITH OUT CHAIN  
1MT CHAIN SUPPLIED  
H-40cm(ADJ)  
W-20cm



**1000717**

**PARAMOUNT  
W/DERBY 9"  
OPAL MATT  
1/LT PND  
BLACK FLEX  
PATINA BLK**

**E27**

FRAME SIZE  
WITH OUT CHAIN  
1MT CHAIN SUPPLIED  
H-44cm(ADJ)  
W-23cm



**1000718**

**PARAMOUNT  
W/DERBY 13"  
OPAL MATT  
1/LT PND  
BLACK FLEX  
PATINA BLK**

**E27**

FRAME SIZE  
WITH OUT CHAIN  
1MT CHAIN SUPPLIED  
H-48cm(ADJ)  
W-33cm



# - Glassware Range -



**3090009**

**5008/29mm  
FROST/ETCHED**  
29mm HOLE  
H-120mm W-140mm



**3090005**

**ZIPPER 23 FROST**  
2 1/4" FITTER  
H-115mm W-118mm



**3090004**

**ZIPPER 23 CLEAR**  
2 1/4" FITTER  
H-115mm W-118mm



**3090020**

**CAMBRIDGE  
FROST ETCHED BRASS**  
4 1/4" FITTER  
H-320mm W-220mm



**3090027**

**CLAREDON SMALL - CLEAR**  
2 1/4" FITTER  
H-95mm W-168mm



**3090032**

**CONO OPAL MATT**  
29Mmm HOLE  
H-100mm W-145mm



**3090031**

**CONO CLEAR**  
29Mmm HOLE  
H-100mm W-145mm



**3090033**

**DECATRON  
OPAL MATT**  
29mm HOLE  
H-95mm W-120mm



**3090061**

**SPHERE 12" OPAL GLOSS**  
4 1/4" FITTER  
H-310mm W-300mm



**3090060**

**SPHERE 10" OPAL GLOSS**  
4 1/4" FITTER  
H-260mm W-250mm



**3090063**

**SPHERE 8" OPAL GLOSS**  
4 1/4" FITTER  
H-210mm W-200mm



**3090062**

**SPHERE 6" OPAL GLOSS**  
3 1/4" FITTER  
H-155mm W-150mm



**3090055**

**SHEFFIELD 12" FRENCH ETCHED**  
4 1/4" FITTER  
H-310mm W-300mm



**3090054**

**SHEFFIELD 10" FRENCH ETCHED**  
4 1/4" FITTER  
H-260mm W-250mm



**3090057**

**SHEFFIELD 8" FRENCH ETCHED**  
4 1/4" FITTER  
H-210mm W-200mm



**3090056**

**SHEFFIELD 6" FRENCH ETCHED**  
3 1/4" FITTER  
H-155mm W-150mm

***- Glassware Range -***



**3090068**

**VICTORIAN 16" SCHOOLHOUSE  
OPAL MATT  
6 1/4" FITTER  
H-270mm W-400mm**



**3090067**

**VICTORIAN 12" SCHOOLHOUSE  
OPAL MATT  
4 1/4" FITTER  
H-210mm W-300mm**



**3090069**

**VICTORIAN 9" SCHOOLHOUSE  
OPAL MATT  
4 1/4" FITTER  
H-165mm W-230mm**



**3090036**

**DETROIT LARGE  
OPAL MATT  
6 1/4" FITTER  
H-220mm W-340mm**



**3090037**

**DETROIT SMALL  
OPAL MATT  
4 1/4" FITTER  
H-120mm W-200mm**



**3090042**

**LINCOLN SCHOOLHOUSE  
OPAL MATT  
6 1/4" FITTER  
H-240mm W-360mm**



**3090043**

**MOULINS  
OPAL MATT  
4 1/4" FITTER  
H-180mm W-300mm**

***New  
Opal  
Matt***



**3090022**

**CHATEAU  
OPAL MATT  
6 1/4" FITTER  
H-150mm W-300mm**



**3090017**

**BEEHIVE 10"  
OPAL MATT  
4 1/4" FITTER  
H-185mm W-250mm**



**3090038**

**DOMEC  
OPAL MATT  
4 1/4" FITTER  
H-190mm W-200mm**



**3090045**

**PARKVILLE 9"  
OPAL MATT  
4 1/4" FITTER  
H-180mm W-220mm**



**3090021**

**CANNES  
OPAL MATT  
4 1/4" FITTER  
H-135mm W-220mm**

# - Glassware Range -



**3090053**

**SENATOR 8"**  
**OPAL MATT**  
4 1/4" FITTER  
H-220mm W-200mm



**3090018**

**BERGERAC**  
**OPAL MATT**  
6 1/4" FITTER  
H-410mm W-225mm



**3090066**

**ST KILDA 9"**  
**OPAL MATT**  
4 1/4" FITTER  
H-200mm W-210mm



**3090064**

**ST KILDA 14"**  
**OPAL MATT**  
12 1/4" FITTER  
H-220mm W-360mm



**3090050**

**SENATOR 11"**  
**OPAL MATT**  
8 1/4" FITTER  
H-155mm W-280mm



**3090035**

**DERBY 9"**  
**OPAL MATT**  
4 1/4" FITTER  
H-180mm W-220mm



**3090034**

**DERBY 13"**  
**OPAL MATT**  
6 1/4" FITTER  
H-240mm W-320mm



**3090051**

**SENATOR 14"**  
**OPAL MATT**  
12 1/4" FITTER  
H-180mm W-355mm



**3090047**

**PREMIER 8"**  
**OPAL MATT**  
4 1/4" FITTER  
H-195mm W-200mm



**3090046**

**PREMIER 12"**  
**OPAL MATT**  
8 1/4" FITTER  
H-265mm W-310mm



**3090052**

**SENATOR 17"**  
**OPAL MATT**  
3 CHAIN SUSPENSION ONLY -  
H-220mm W-425mm



**3090040**

**EMPIRE 8"**  
**OPAL MATT**  
4 1/4" FITTER  
H-245mm W-200mm



**3090039**

**EMPIRE 14"**  
**OPAL MATT**  
12 1/4" FITTER  
H-190mm W-340mm

# - Metal Shade Range -

## The Original Coolie Metal Shade



3090277

**EDWARDIAN**  
**250mm**  
**WHITE**  
29mm HOLE



3090275

**EDWARDIAN**  
**250mm**  
**BLACK**  
29mm HOLE



3090280

**EDWARDIAN**  
**390mm**  
**WHITE**  
29mm HOLE



3090278

**EDWARDIAN**  
**390mm**  
**BLACK**  
29mm HOLE

## The Original Warehouse / Tennis Court Metal Shade



3090283

**WAREHOUSE**  
**300mm**  
**WHITE**  
29mm HOLE



3090281

**WAREHOUSE**  
**300mm**  
**BLACK**  
29mm HOLE



3090286

**WAREHOUSE**  
**420mm**  
**WHITE**  
29mm HOLE



3090284

**WAREHOUSE**  
**420mm**  
**BLACK**  
29mm HOLE

# Lighting Inspirations

## \* Conditions Of Sale \*

\* **Payment** terms, Strictly Nett: 30 Days - For customers with approved credit facilities.

\* **Prices** can change without notification. Prices exclude GST.

**Approved** 30 day credit application only.

\* **Goods Returned** approved or authorized only by fax/email confirmation from Lode International. No goods may be returned without Lode Int authorization. Product must be unopened and returned in its original packing.

\* **Electrically Faulty** installed product, confirmed by qualified Electrician are covered by Lode International. If this product is found not to be electrically faulty or retailers customer decides product is not suitable, wrong size, etc a 30% restocking fee, freight charges & breakage charges if applicable will be applied.

\* **Claims** no later than 7 days from date of delivery, invoice numbers must be quoted.

\* **Retention** of title until payment received as detailed on original invoices.

\* **All images**, drawings, particulars, specifications, weights, and dimensions & all promotional material used by Lode Int is intended to be illustrative only. None of the foregoing nor any particulars or representations contained therein shall form part nor deemed to have been incorporated in any contract with Lode Int. Lode Int reserves the right to change product dimensions and technical details at any time without notice.

## - Freight Charges -

Our prices do not include freight, therefore all orders will incur freight charges subject to the below conditions.

### \*1 -Freight To The Metropolitan Areas Of - Melbourne, Sydney, Brisbane, Adelaide, Perth & Canberra\*

A) FIS (No Freight Charge) If Your order is above \$300.00 (Ex GST)

B) If Your order is under \$300.00 (Ex GST) A Freight will be charged per carton, with a minimum charge of \$30.00 + GST.

C) Any freight (regardless of the order value) going to a different address than your business address or being delivered directly to your customer, will be charged freight per carton. We will advise you of the freight charge prior to dispatch for you to decide if it is acceptable or you wish to organize alternative freight arrangements.

### \*2 -Freight To - Darwin & Regional Country Areas Of Any State\*

Freight per carton will be chargeable, regardless of the order value. We will advise the freight charge prior to dispatch for you to decide if it is acceptable or you wish to organize alternative freight arrangements.

### \*3 -Freight To - Tasmania

FIS (No Freight Charge) If your order is delivered to an on forwarder located in the Melbourne metropolitan area and the value of the order is above \$300.00(ex-GST). If the order is below \$300.00 freight charge per carton applies with a minimum of \$30.00 + GST.

For orders delivered directly to Tasmania to you or to your customer (With an ATL), freight charge per carton will be charged regardless of the order value, we will quote you the freight charge before dispatching.

### \*4 - Freight Delivered Directly to Your Customer\*

Freight per carton will always be charged regardless of the order value and destination (Metro or Country Area).

Subject to providing the following:

1 - An authority to leave to an unrestricted ground floor area.

2 - You unreservedly accept any re-delivery freight charges that the freight company charges us, due to the authority to leave not being able to be completed on the first delivery attempt and thus requiring a redelivery and a further charge.

## \* To The Customer \*

It is important that we and our retailers advise our clients of the unique characteristics of our products. As our products are hand made and finished, they will not be perfect and we see this as their unique appeal.

Therefore -

- Metal castings and extrusions will have imperfections in the surface. Lamp holders may not be perfectly straight.
- Hand welding will not be perfectly straight and there may be surface finish imperfections due to chemical plating& hand finishing.
- Hand-blown glassware may have bubbles, pin dots, slight lines, rippling, cut edges & be slightly off center.
- Paint color will vary from batch to batch & in case of hand painted finish, each product will be marginally different.

## \* Please Note \*

\* All items are inspected for visible defects before dispatch, we therefore also recommend the retailer does the same before giving to their customer in case of damage in transit. If not inspected, Lode Int. will not accept liability for installation or any other claims for visibly faulty goods. Report any breakage or faults immediately before giving to your customer for replacement parts or fitting.

\* Under no circumstances will Lighting Inspirations (Lode Int) pay electrician fees.

\* We will not recognize or accept any unreasonable claim relating to the unique characteristics of our hand made products.

\* Products can only be returned if unopened and in original packaging.

\* Products modified to customer request cannot be returned.

\* Products ordered separately over time may not match exactly because of color batching or manufacturing changes.

No claim related to separate ordering over time will be recognized.

\* Products can change or vary without notice.

\* Images are the property of Lode International. Images of products are illustrative only. There use is only permissible with written consent.

\* Lode International is not liable for damage/altering the integrity of the light fittings due to faulty globes.

\* Lode International is an accredited E.R.A.C "Responsible Supplier". To Check Compliance - EESS.gov.au - Lode Lighting/ESV-106126 - E2722

\* Catalogue [Index](#), [Globe Required Chart](#) and [IP Rating Chart](#) are behind front cover

