

Above Counter | Inset | Semi-Recessed | Under Counter

Timberline

Basin Collection





The Basin Collection offers an extensive variety to match your unique style.



At Timberline we strive to bring you only the most elegant and stylish basins for your new bathroom, whether that's ceramic, mineral composite or stainless steel.

This brochure has everything you need to know about our stunning above counter, inset, semi-recessed and under counter basins in one place.



HERE'S A QUICK GUIDE ON HOW THIS BROCHURE WORKS

Colours

The below icons provide a quick reference to available basin colours and relate to individual codes and pricing.

WG White Gloss	PM Pink Matt
WM White Matt	BM Blue Matt
BKM Black Matt	MM Mint Matt
ANT Anthracite	BG Brushed Gold
GM Grey Matt	BN Brushed Nickel
LGM Light Grey Matt	

Basin Material

Choose from ceramic, mineral composite or stainless steel.

Basin Type

Our basins fit into four categories – above counter, inset, semi-recessed and under counter.

Warranty Periods

Ceramic	5 Year
Mineral Composite	10 Year
Stainless Steel	1 Year

Pricing

All prices are Recommended Retail Price (RRP) including GST. Prices may vary depending on location and are subject to change or correction without notification.

All information is provided on a E&OE (errors and omissions excepted) basis. There is a huge amount of very useful information in this brochure and there is more than likely an error, big or small, somewhere.

Images in this brochure are shown with accessories and other furniture not included in the price or supplied by Timberline.



Ceramic Collection

- ✓ Traditional look and feel
- ✓ Heat resistant
- ✓ 5 year warranty

- ✗ Susceptible to chipping
- ✗ Surface variations to be expected due to basins being hand made from natural materials
- ✗ Susceptible to cracking due to impact

Note: Due to the manufacturing process, ceramic basins will vary from their nominal stated sizes. Use the dimensions provided as a guide only.

Allure



Availability

WG	ALL-BS-360-WG-S	\$233
WM	ALL-BS-360-WM-U	\$385
BKM	ALL-BS-360-BKM-U	\$385
ANT	ALL-BS-360-ANT-U	\$385
GM	ALL-BS-360-GM-U	\$385
LGM	ALL-BS-360-LGM-U	\$385
PM	ALL-BS-360-PM-U	\$385
BM	ALL-BS-360-BM-U	\$385
MM	ALL-BS-360-MM-U	\$385

Approx Capacity: 8.5L

Cut Out Size: 80mm

Waste Size: 32mm without overflow

Min. Top Width x Depth OTH 380w x 360d

Min. Top Width x Depth 1TH Behind 380w x 460d



Above Counter

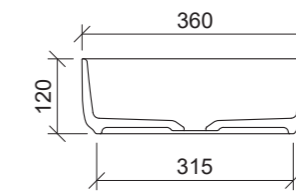
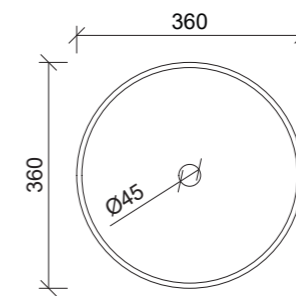

Drawings

Taphole Offset

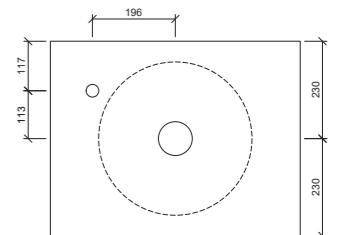

Taphole Behind

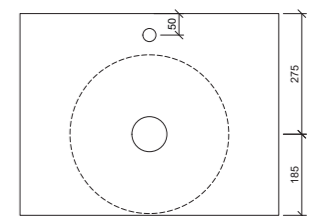

Cut Out Specifications

Note: Waste not included.

Allure Arrow



Availability

WG ALA-BS-360-WG-S	\$233	Approx Capacity: 8.5L	Min. Top Width x Depth OTH	380w x 360d
WM ALA-BS-360-WM-U	\$385	Cut Out Size: 80mm	Min. Top Width x Depth 1TH Behind	380w x 460d
		Waste Size: 32mm without overflow		

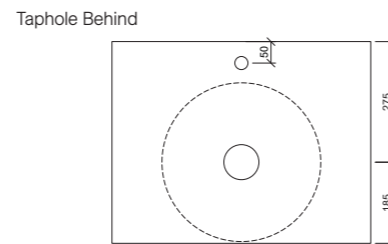
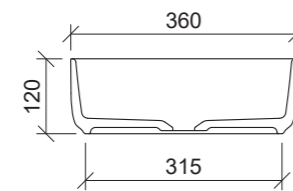
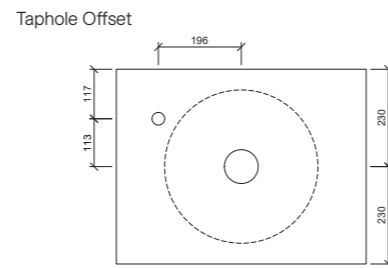
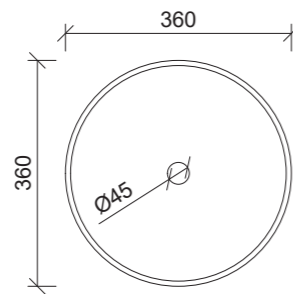

Above Counter

Drawings

Cut Out Specifications

Note: Waste not included.

Allure Dimple



Availability

WG ALD-BS-360-WG-S	\$233	Approx Capacity: 8.5L	Min. Top Width x Depth OTH	380w x 360d
WM ALD-BS-360-WM-U	\$385	Cut Out Size: 80mm	Min. Top Width x Depth 1TH Behind	380w x 460d
		Waste Size: 32mm without overflow		

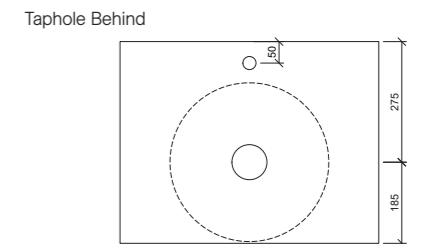
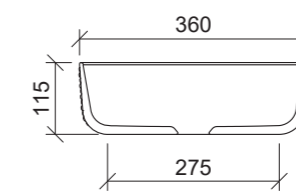
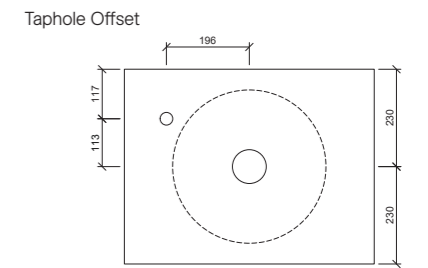
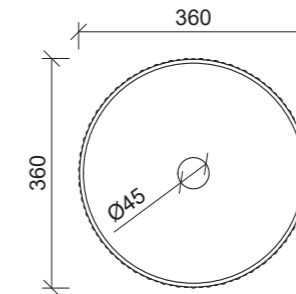

Above Counter

Drawings

Cut Out Specifications

Note: Waste not included.

Allure Flute



Availability

WG	ALF-BS-360-WG-S	\$233
WM	ALF-BS-360-WM-U	\$385

Approx Capacity: 8.5L
Cut Out Size: 80mm
Waste Size: 32mm without overflow

Min. Top Width x Depth OTH 380w x 360d
Min. Top Width x Depth 1TH Behind 380w x 460d

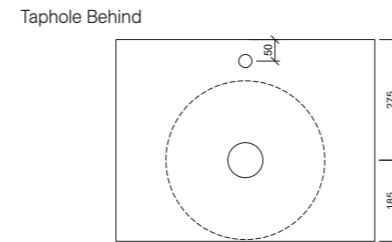
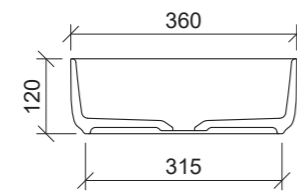
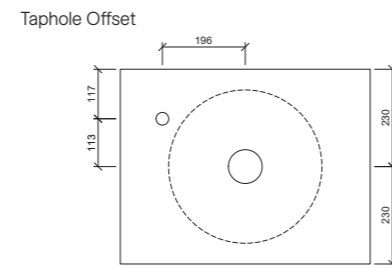
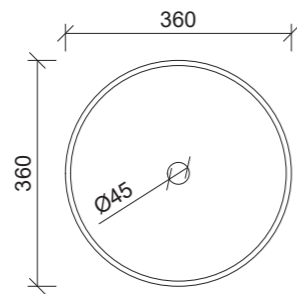

Above Counter

Drawings

Cut Out Specifications

Note: Waste not included.

Allure Raked



Availability

WG	ALR-BS-360-WG-S	\$233
WM	ALR-BS-360-WM-U	\$385

Approx Capacity: 8.5L
Cut Out Size: 80mm
Waste Size: 32mm without overflow

Min. Top Width x Depth OTH 380w x 360d
Min. Top Width x Depth 1TH Behind 380w x 460d

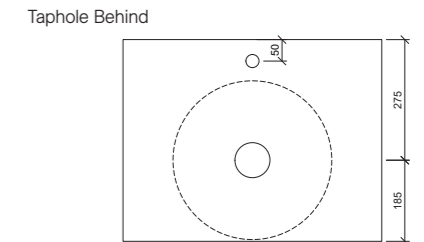
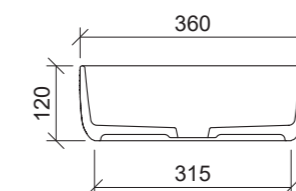
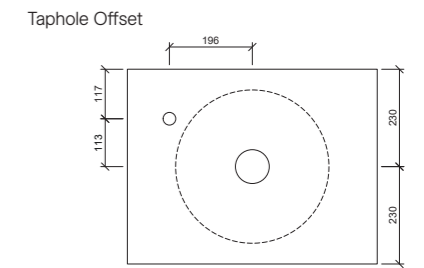
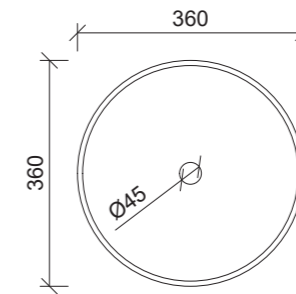
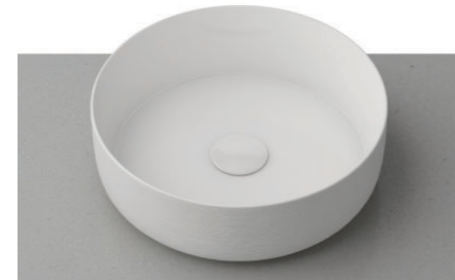

Above Counter

Drawings

Cut Out Specifications

Note: Waste not included.

Bloom



Availability

WG BLO-BS-475-WG-S \$233

Approx Capacity: 4.6L

Cut Out Size: 80mm

Waste Size: 32mm without overflow

Min. Top Width x Depth OTH 570w x 245d

Min. Top Width x Depth 1TH Behind 570w x 330d

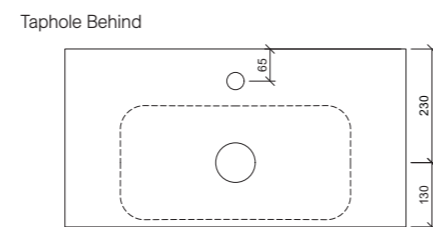
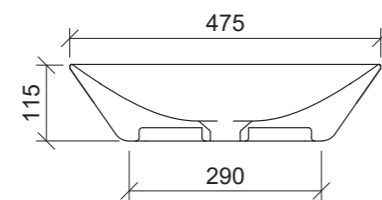
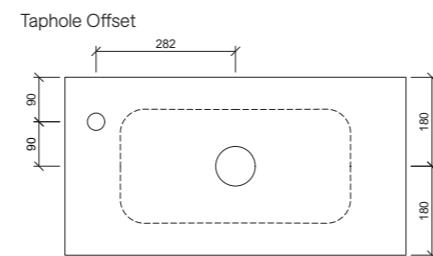
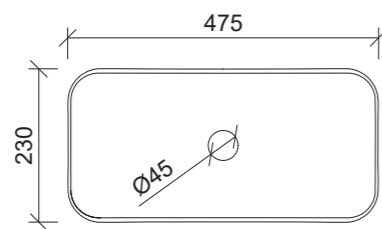

Above Counter

Drawings

Cut Out Specifications

Note: Waste not included.

Bonnie



Availability

WG BON-BS-560-WG-S \$233

Approx Capacity: 9.3L

Cut Out Size: 80mm

Waste Size: 32mm without overflow

WM BON-BS-560-WM-U \$385

Min. Top Width x Depth OTH 660w x 410d

Min. Top Width x Depth 1TH Behind 660w x 495d

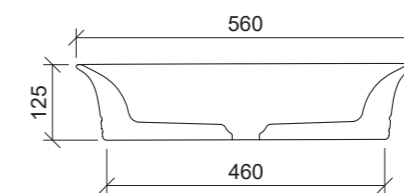
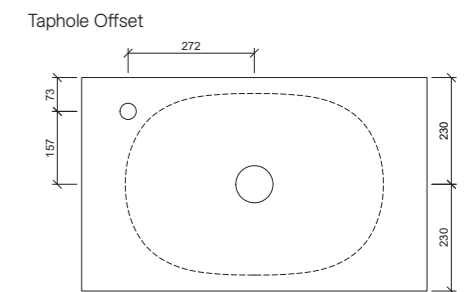
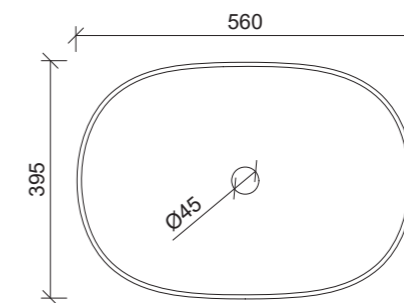

Above Counter

Drawings

Cut Out Specifications

Note: Waste not included. Offset or wall mounted tapware required for standard (460mm) cabinets.

Chase



Availability

WG CHA-BS-400-WG-S \$233
WM CHA-BS-400-WM-U \$385

Approx Capacity: 8.7L
Cut Out Size: 80mm
Waste Size: 32mm without overflow

Min. Top Width x Depth OTH 450w x 415d
Min. Top Width x Depth 1TH Behind 450w x 500d

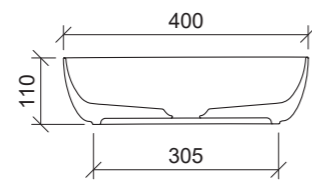
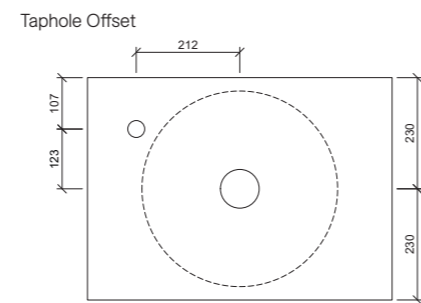
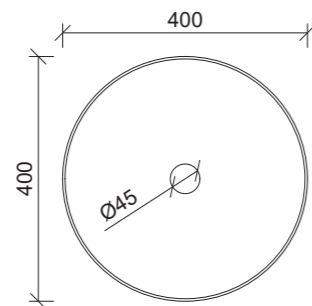

Above Counter

Drawings

Cut Out Specifications

Note: Waste not included. Offset or wall mounted tapware required for standard (460mm) cabinets.

Diamond



Availability

WG DIA-BS-360-WG-S \$233
WM DIA-BS-360-WM-U \$385

Approx Capacity: 8.5L
Cut Out Size: 80mm
Waste Size: 32mm without overflow

Min. Top Width x Depth OTH 380w x 370d
Min. Top Width x Depth 1TH Behind 380w x 460d

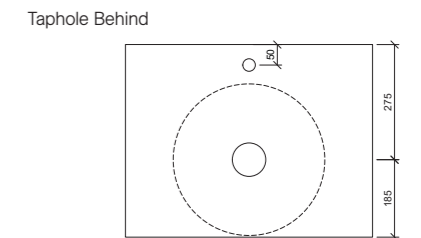
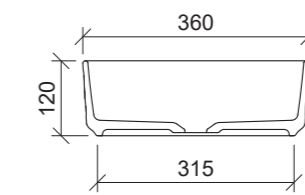
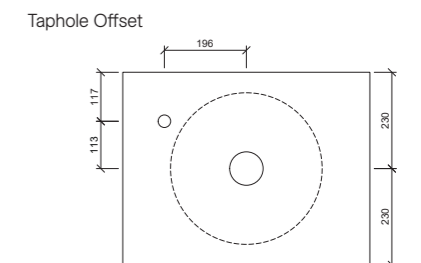
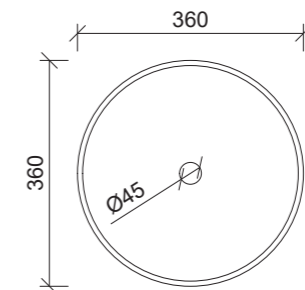

Above Counter

Drawings

Cut Out Specifications

Note: Waste not included.

Elite



Availability

WG ELI-BS-415-WG-S	\$233	Approx Capacity: 6L	Min. Top Width x Depth OTH	520w x 350d
WM ELI-BS-415-WM-U	\$385	Cut Out Size: 80mm	Min. Top Width x Depth 1TH Behind	520w x 435d
BKM ELI-BS-415-BKM-U	\$385	Waste Size: 32mm without overflow		

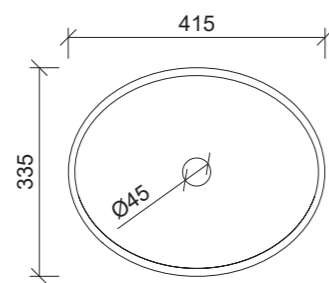

Taphole Offset

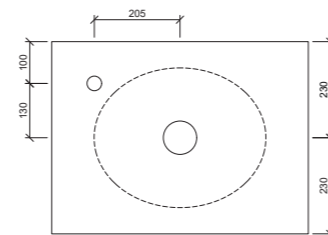

Taphole Behind

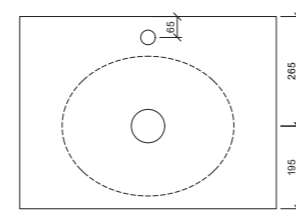

Above Counter

Drawings

Cut Out Specifications

Note: Waste not included.

Enchant



Availability

WG ENC-BS-500-WG-S	\$233	Approx Capacity: 14L	Min. Top Width x Depth OTH	600w x 370d
WM ENC-BS-500-WM-U	\$385	Cut Out Size: 80mm	Min. Top Width x Depth 1TH Behind	600w x 460d
BKM ENC-BS-500-BKM-U	\$385	Waste Size: 32mm without overflow		
GM ENC-BS-500-GM-U	\$385			

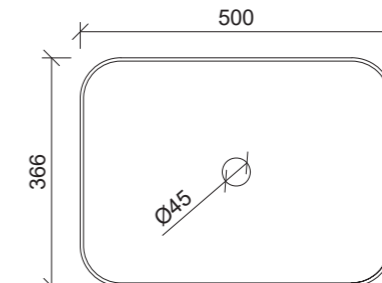

Taphole Offset

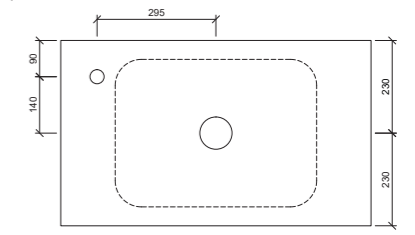

Taphole Behind

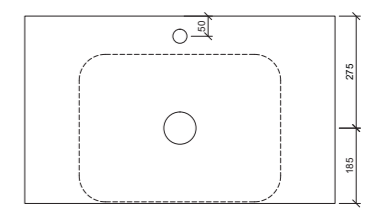

Above Counter

Drawings

Cut Out Specifications

Note: Waste not included. Anthracite waste required to match Grey Matt basin.

Feather



Availability

WG FEA-BS-500-WG-S	\$233	Approx Capacity: 5.6L	Min. Top Width x Depth OTH	600w x 360d
WM FEA-BS-500-WM-U	\$385	Cut Out Size: 80mm	Min. Top Width x Depth 1TH Behind	600w x 450d
BKM FEA-BS-500-BKM-U	\$385	Waste Size: 32mm without overflow		

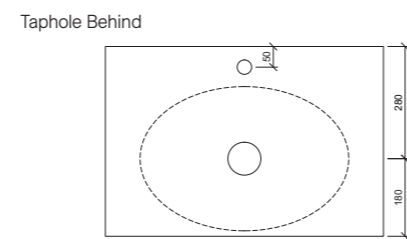
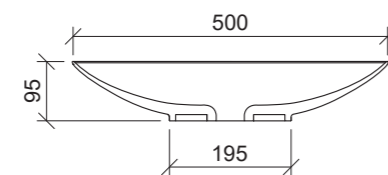
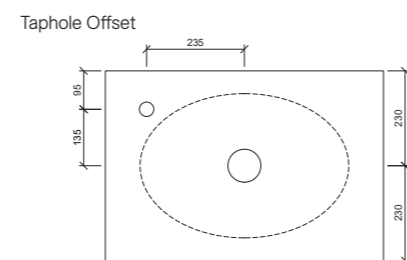
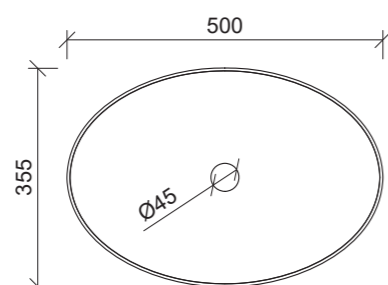

Above Counter

Drawings

Cut Out Specifications

Note: Waste not included.

Florent



Availability

WG FLO-BS-400-WG-S	\$233	Approx Capacity: 10.4L	Min. Top Width x Depth OTH	500w x 415d
		Cut Out Size: 80mm	Min. Top Width x Depth 1TH Behind	500w x 500d
		Waste Size: 32mm without overflow		

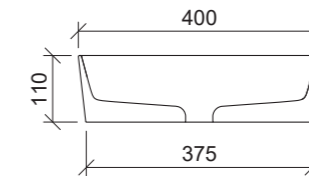
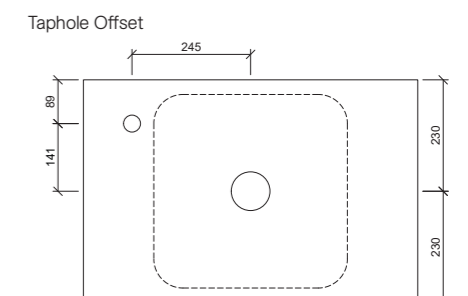
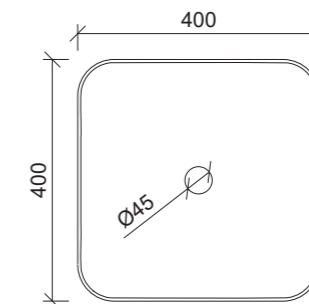

Above Counter

Drawings

Cut Out Specifications

Note: Waste not included. Offset or wall mounted tapware required for standard (460mm) cabinets.

Gem



Availability

WG GEM-BS-305-WG-S \$233

Approx Capacity: 5.8L

Cut Out Size: 80mm

Waste Size: 32mm without overflow

Min. Top Width x Depth OTH 320w x 320d

Min. Top Width x Depth 1TH Behind 320w x 405d

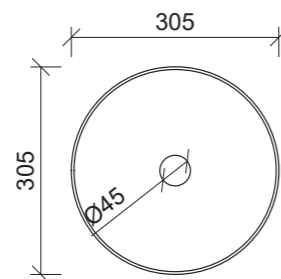

Taphole Offset

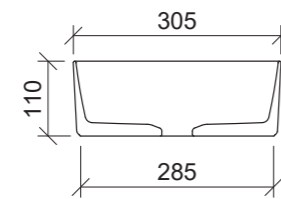
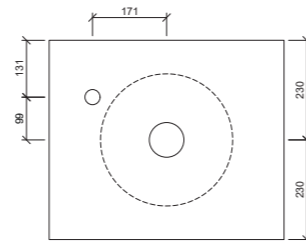

Taphole Behind

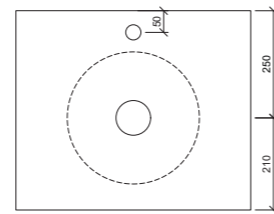

Above Counter

Drawings

Cut Out Specifications

Note: Waste not included.

Iconic 420



Availability

WG ICN-BS-420-WG-S \$233

Approx Capacity: 4.8L

Cut Out Size: 100mm w x 260mm d

Waste Size: 32mm with overflow

Min. Top Width x Depth 440w x 430d

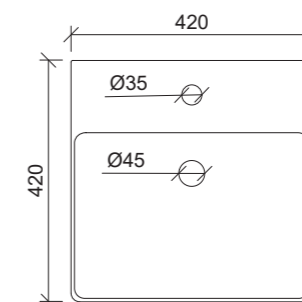

Taphole Offset

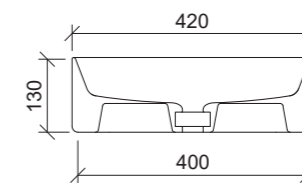
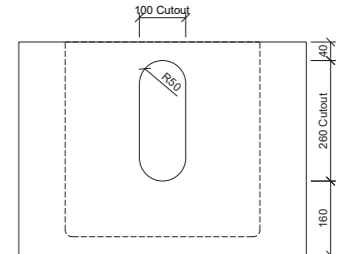

Above Counter

Drawings

Cut Out Specifications

Note: Waste not included. Comes with tap landing. Chrome overflow only.

Iconic 500



Availability

WG ICN-BS-500-WG-S	\$233	Approx Capacity: 5.7L	Min. Top Width x Depth 520w x 430d
		Cut Out Size: 100mm w x 260mm d	
		Waste Size: 32mm with overflow	

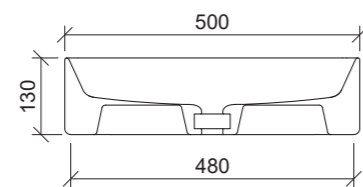
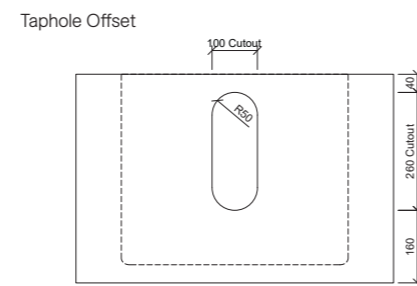
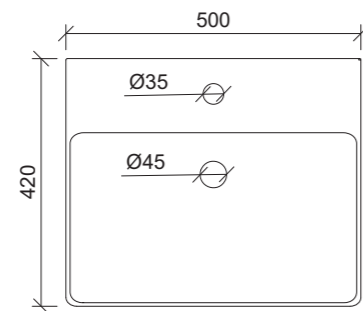

Above Counter

Drawings

Cut Out Specifications

Note: Waste not included. Comes with tap landing. Chrome overflow only.

Jessie



Availability

WG JES-BS-320-WG-S	\$233	Approx Capacity: 5.5L	Min. Top Width x Depth OTH 450w x 335d
WM JES-BS-320-WM-U	\$385	Cut Out Size: 80mm	Min. Top Width x Depth 1TH Behind 450w x 420d
		Waste Size: 32mm without overflow	

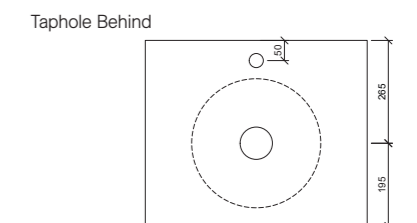
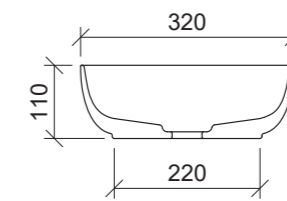
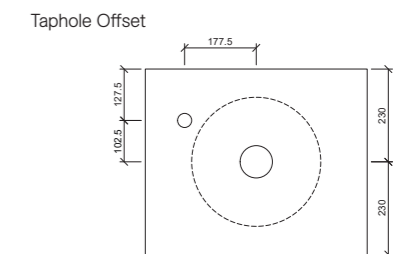
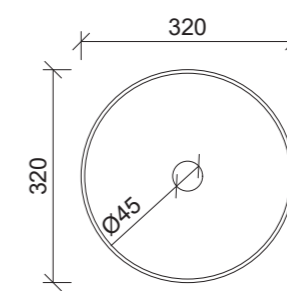

Above Counter

Drawings

Cut Out Specifications

Note: Waste not included.

Jupiter



White Gloss Jupiter Ceramic Basins

Availability

WG JUP-BS-450-WG-S \$233

Approx Capacity: 6.9L

Cut Out Size: 80mm

Waste Size: 32mm without overflow

Min. Top Width x Depth OTH 470w x 460d

Min. Top Width x Depth 1TH Behind 470w x 545d

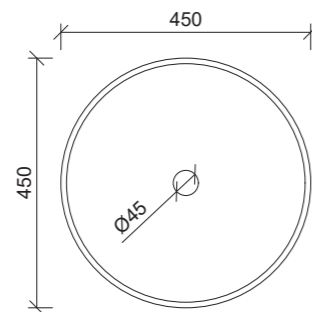

Taphole Offset

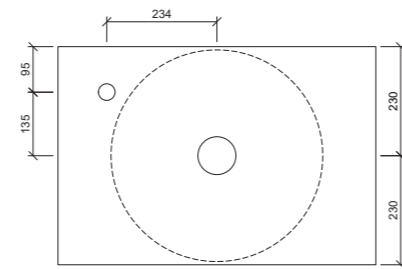

Above Counter

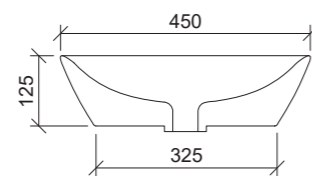

Drawings

Cut Out Specifications

Note: Waste not included. Offset or wall mounted tapware required for standard (460mm) cabinets.

Myrtle



White Gloss Myrtle Ceramic Basin

Availability

WG MYR-BS-550-WG-S \$233

Approx Capacity: 15.1L

Cut Out Size: 80mm

Waste Size: 32mm without overflow

WM MYR-BS-550-WM-U \$385

BKM MYR-BS-550-BKM-U \$385

Min. Top Width x Depth OTH 650w x 360d

Min. Top Width x Depth 1TH Behind 650w x 460d

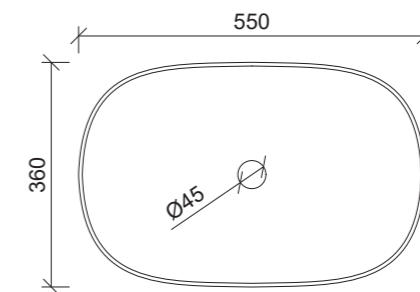

Taphole Offset

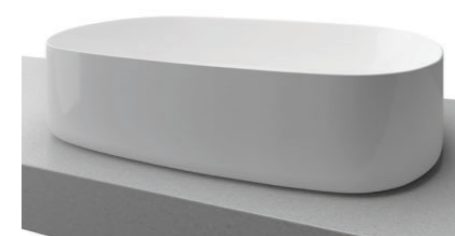
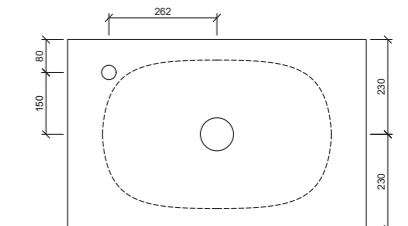

Above Counter

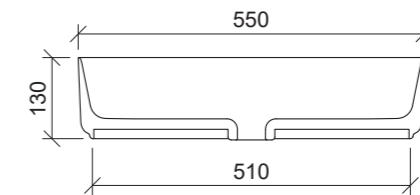

Drawings

Taphole Behind

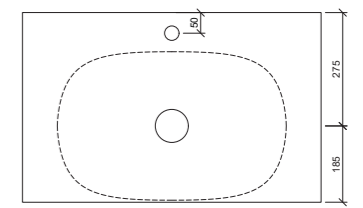

Cut Out Specifications

Note: Waste not included.

Oval Flute



Availability

WG OVF-BS-490-WG-S \$233
WM OVF-BS-490-WM-U \$385

Approx Capacity: 10L
Cut Out Size: 80mm
Waste Size: 32mm without overflow

Min. Top Width x Depth OTH 590w x 335d
Min. Top Width x Depth 1TH Behind 590w x 415d

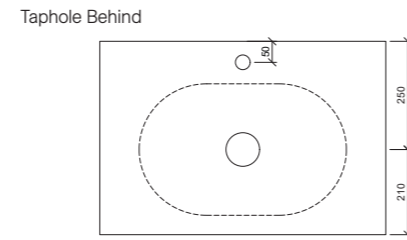
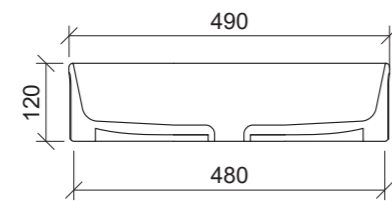
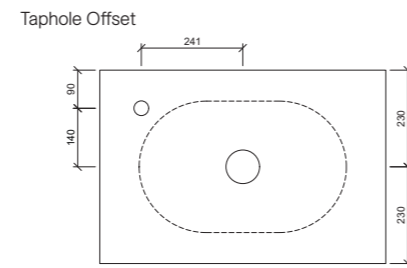
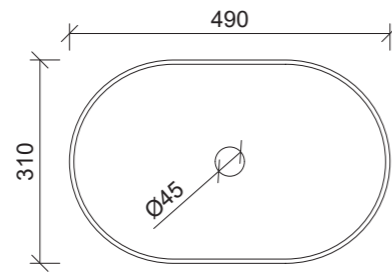

Above Counter

Drawings

Cut Out Specifications

Note: Waste not included.

Quill



Availability

WG QUI-BS-600-WG-S \$233

Approx Capacity: 15.2L
Cut Out Size: 80mm
Waste Size: 32mm without overflow

Min. Top Width x Depth OTH 670w x 430d
Min. Top Width x Depth 1TH Behind 670w x 515d

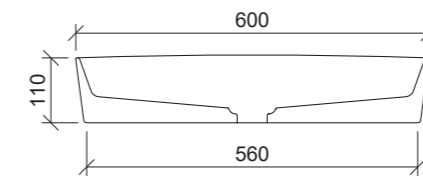
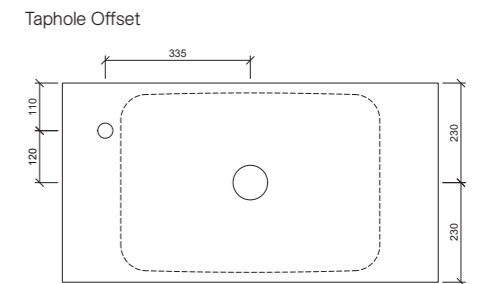
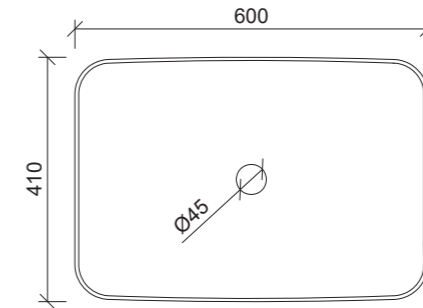

Above Counter

Drawings

Cut Out Specifications

Note: Waste not included. Offset or wall mounted tapware required for standard (460mm) cabinets.

Rose



Availability

WG ROS-BS-320-WG-S \$233

Approx Capacity: 5.7L

Cut Out Size: 80mm

Waste Size: 32mm without overflow

Min. Top Width x Depth OTH 340w x 340d

Min. Top Width x Depth 1TH Behind 340w x 425d

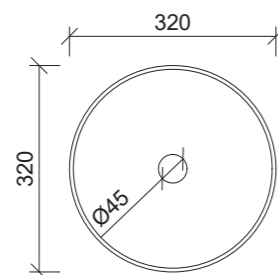

Taphole Offset

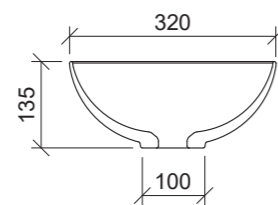
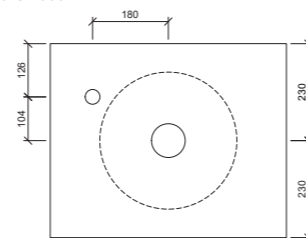

Taphole Behind

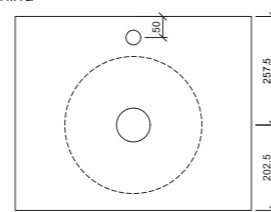

Above Counter

Drawings

Cut Out Specifications

Note: Waste not included.

Addison Inset



Availability

WG ADD-BS-400-WG-S \$233

Approx Capacity: 11L

Cut Out Size: 353mm w x 353mm d

Waste Size: 32mm without overflow

Min. Top Width x Depth OTH 600w x 460d

Min. Top Width x Depth 1TH Behind 600w x 530d

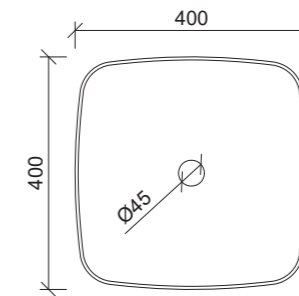

Taphole Offset

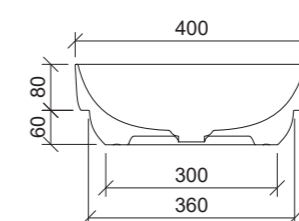
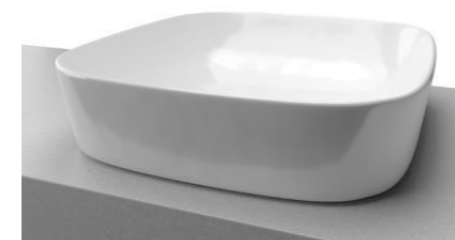
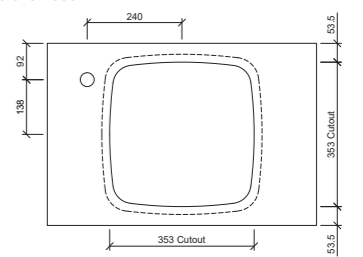

Inset

Drawings

Cut Out Specifications

Note: Waste not included. Offset or wall mounted tapware required for standard (460mm) cabinets.

Arcade Inset



Availability

WG ARC-BS-400-WG-S \$233

Approx Capacity: 10.6L

Cut Out Size: 360mm w x 360mm d

Waste Size: 32mm without overflow

Min. Top Width x Depth OTH 460w x 460d

Min. Top Width x Depth 1TH Behind 460w x 525d

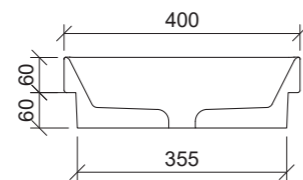
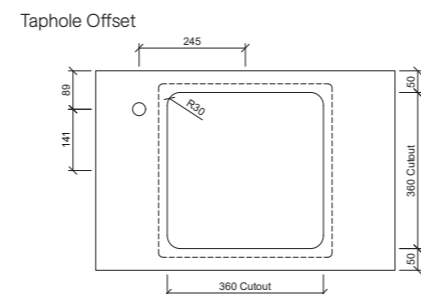
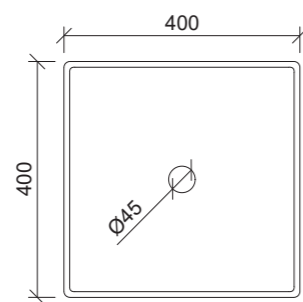

Inset

Drawings

Cut Out Specifications

Note: Waste not included. Offset or wall mounted tapware required for standard (460mm) cabinets.

George Inset



Availability

WG GEO-BS-600-WG-S \$233

Approx Capacity: 13L

Cut Out Size: 576mm w x 346mm d

Waste Size: 32mm without overflow

WM GEO-BS-600-WM-U \$385

Min. Top Width x Depth OTH 750w x 440d

Min. Top Width x Depth 1TH Behind 750w x 500d

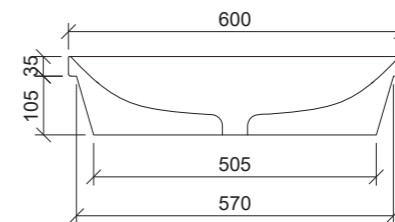
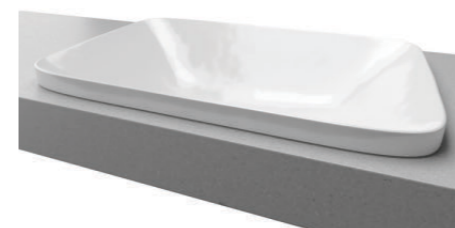
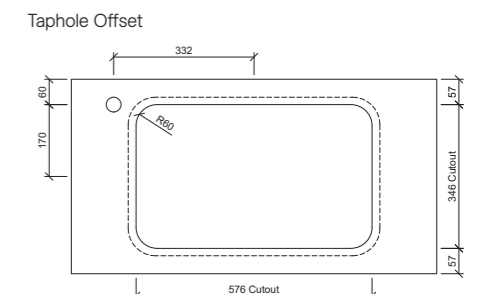
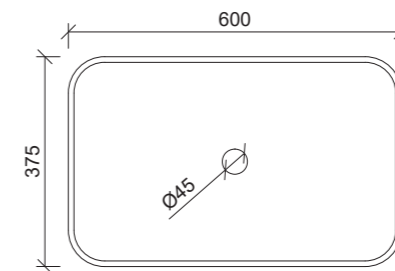

Inset

Drawings

Cut Out Specifications

Note: Waste not included. Offset or wall mounted tapware required for standard (460mm) cabinets.

Lorenzo Inset



White Gloss Lorenzo Inset Ceramic Basin

Availability

WG	LOR-BS-500-WG-S	\$233
WM	LOR-BS-500-WM-U	\$385

Approx Capacity:	11.4L
Cut Out Size:	469mm w x 347mm d
Waste Size:	32mm without overflow

Min. Top Width x Depth OTH	600w x 440d
Min. Top Width x Depth 1TH Behind	600w x 510d

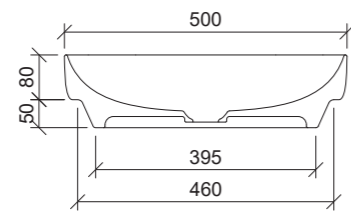
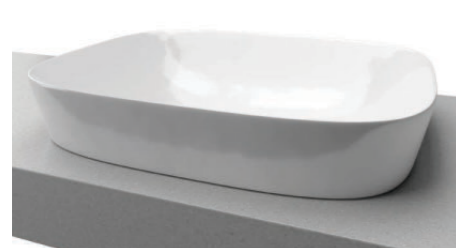
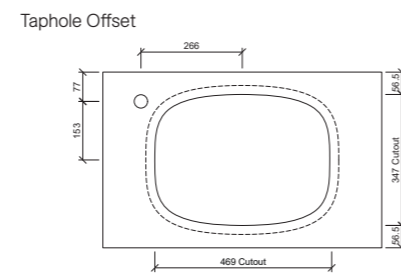
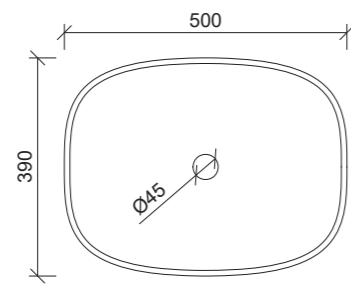

Inset

Drawings

Cut Out Specifications

Note: Waste not included. Offset or wall mounted tapware required for standard (460mm) cabinets.

Radius Inset



White Matt Radius Inset Ceramic Basin

Availability

WG	RAD-BS-400-WG-S	\$233
WM	RAD-BS-400-WM-U	\$385
BKM	RAD-BS-400-BKM-U	\$385

Approx Capacity:	9.4L
Cut Out Size:	365mm
Waste Size:	32mm without overflow

Min. Top Width x Depth OTH	460w x 455d
Min. Top Width x Depth 1TH Behind	460w x 525d

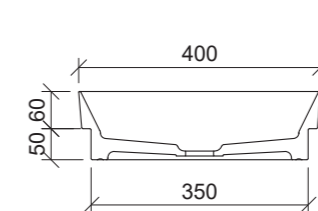
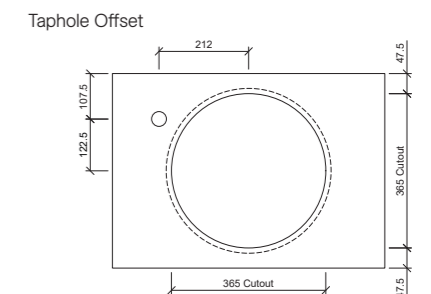
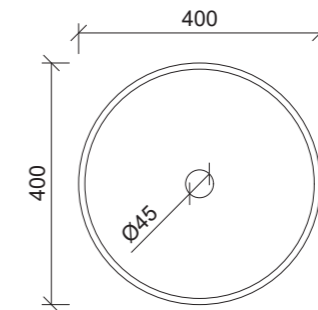

Inset

Drawings

Cut Out Specifications

Note: Waste not included. Offset or wall mounted tapware required for standard (460mm) cabinets.

Rome Inset



Availability

WG ROM-BS-600-WG-S \$233

Approx Capacity: 14L

Cut Out Size: 555mm w x 335mm d

Waste Size: 32mm without overflow

Min. Top Width x Depth OTH 700w x 395d

Min. Top Width x Depth 1TH Behind 700w x 480d

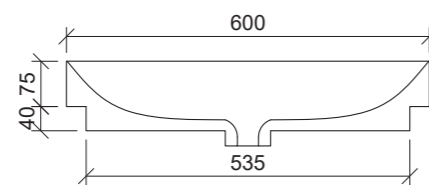
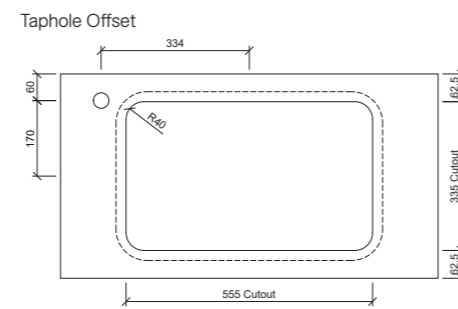
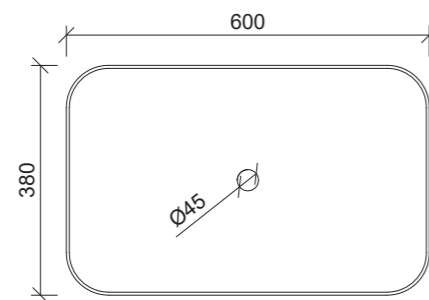

Inset

Drawings

Cut Out Specifications

Note: Waste not included. Offset or wall mounted tapware required for standard (460mm) cabinets.

Mini Rectangle Under Counter



Availability

WG MRE-BS-425-WG-S \$233

Approx Capacity: 5.2L

Cut Out Size: 350mm w x 190mm d

Waste Size: 32mm with overflow

Min. Top Width x Depth OTH 580w x 360d

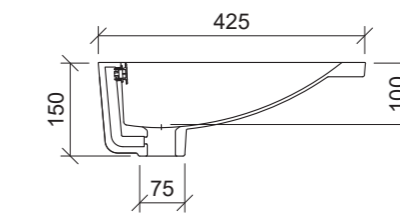
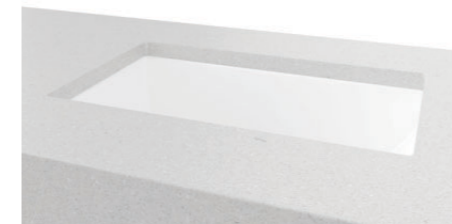
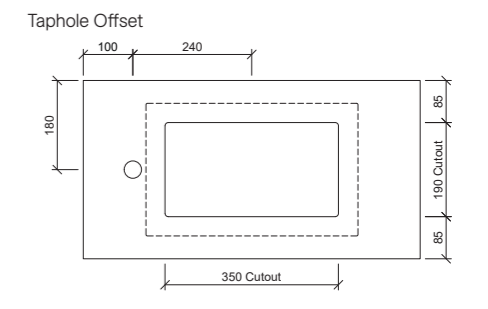
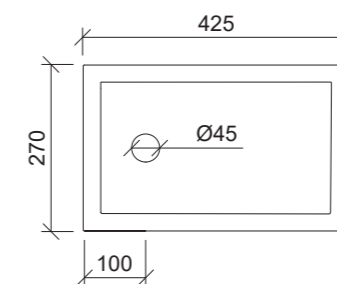

Under Counter

Drawings

Cut Out Specifications

Note: Waste is always offset to left or right. Chrome overflow only.

Mini Round Under Counter



White Gloss Mini Round Under Counter Ceramic Basin

Availability

WG MRO-BS-255-WG-S \$233

Approx Capacity: 2L

Cut Out Size: 205mm

Waste Size: 32mm with overflow

Min. Top Width x Depth OTH 360w x 355d

Min. Top Width x Depth 1TH Behind 360w x 380d

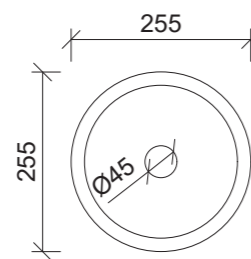

Taphole Offset

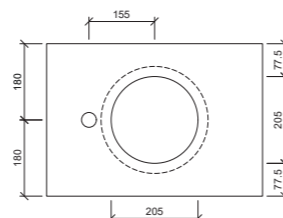

Under Counter

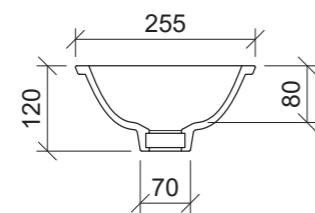

Drawings

Taphole Behind

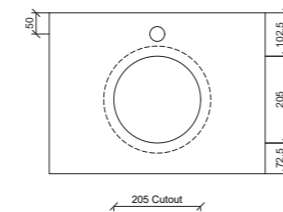

Cut Out Specifications

Note: Waste not included. Chrome overflow only.

Oval Under Counter



White Gloss Oval Under Counter Ceramic Basins

Availability

WG OVL-BS-420-WG-S \$233

Approx Capacity: 8.7L

Cut Out Size: 363mm w x 291mm d

Waste Size: 32mm with overflow

Min. Top Width x Depth OTH 520w x 440d

Min. Top Width x Depth 1TH Behind 520w x 460d

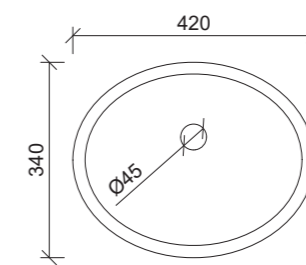

Taphole Offset

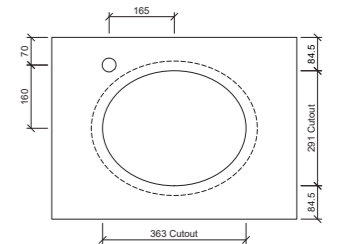

Under Counter

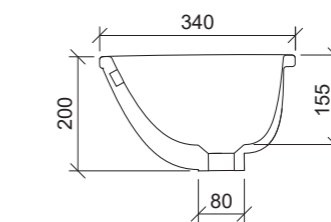

Drawings

Taphole Behind

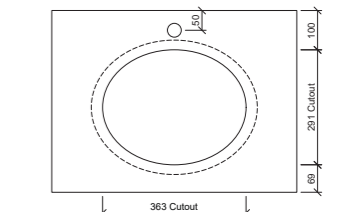

Cut Out Specifications

Note: Waste not included. Chrome overflow only.

Rectangle Under Counter



Availability

WG REC-BS-530-WG-S \$233

Approx Capacity: 7.7L

Cut Out Size: 450mm w x 260mm d

Waste Size: 32mm with overflow

Min. Top Width x Depth OTH 640w x 430d

Min. Top Width x Depth 1TH Behind 640w x 460d

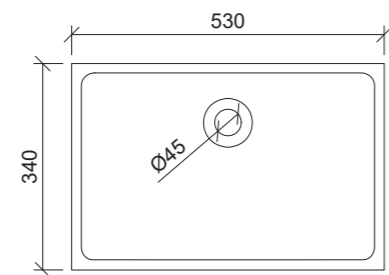

Taphole Offset

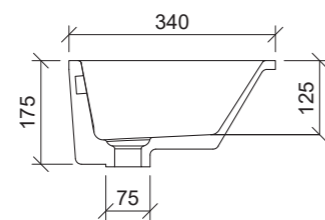
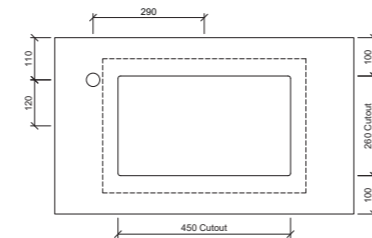

Taphole Behind

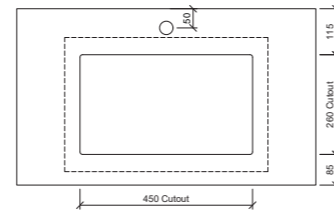

Under Counter

Drawings

Cut Out Specifications

Note: Waste not included. Chrome overflow only.

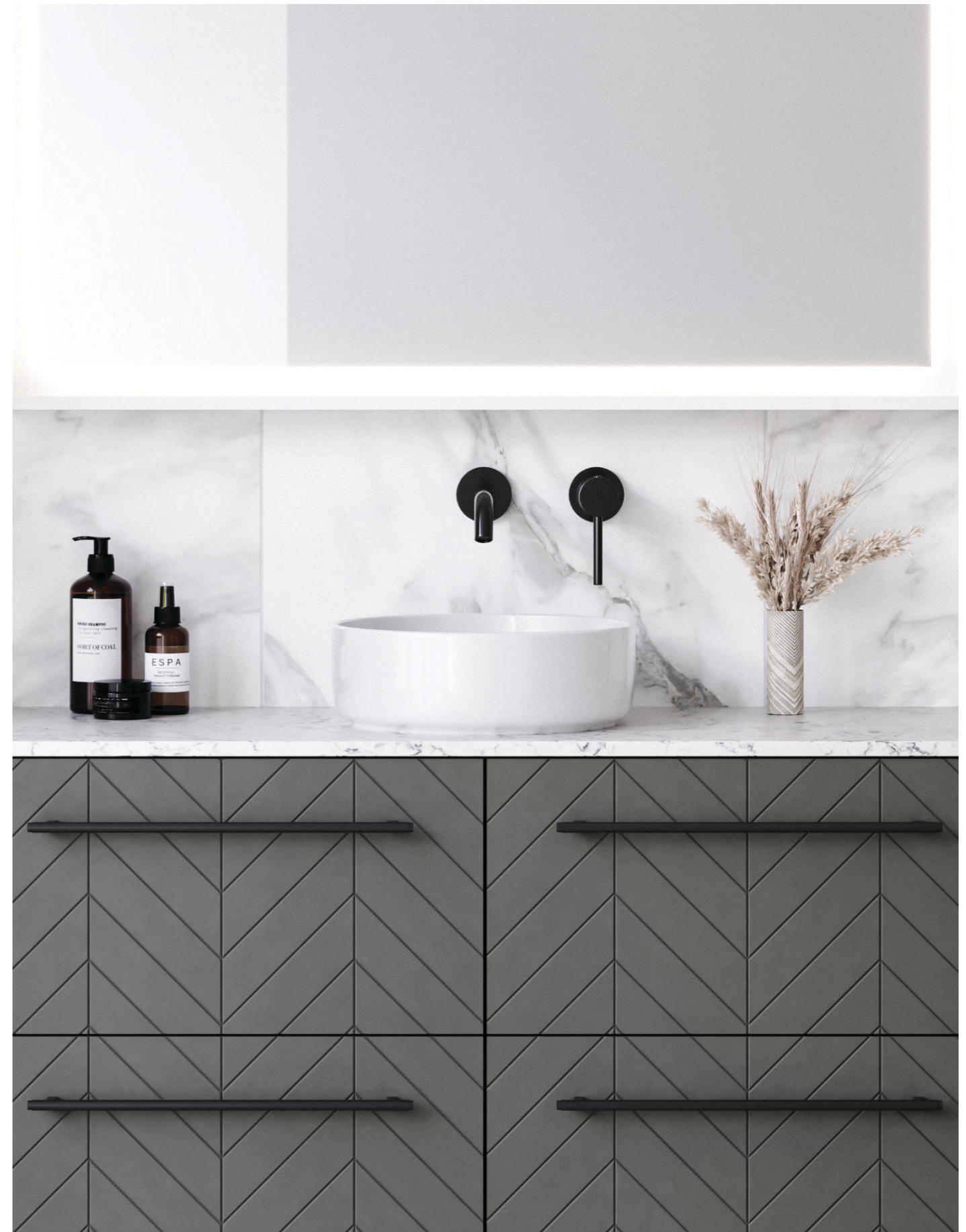



Coast Inset



White Gloss Coast Inset
Mineral Composite Basin

Availability

WG COA-BS-495-WG-U \$385

Approx Capacity: 8.6L

Cut Out Size: 459mm w x 329mm d

Waste Size: 40mm without overflow

Min. Top Width x Depth OTH 600w x 420d

Min. Top Width x Depth 1TH Behind 600w x 495d

Mineral Composite Collection



- ✓ Durable and strong
- ✓ Not susceptible to chipping but easy to repair if scratched
- ✓ Australian made
- ✓ 10 year warranty

✗ Susceptible to heat damage (e.g. hair straightener)

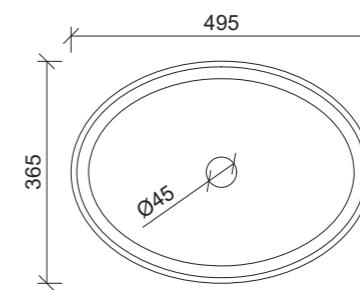

Taphole Offset

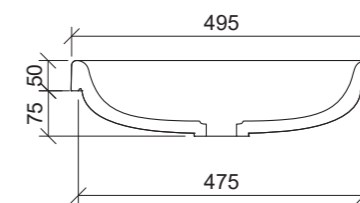
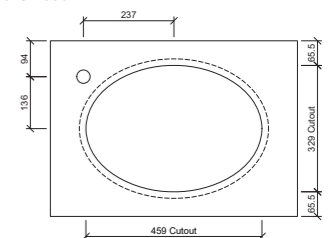

Inset

Drawings

Cut Out Specifications

Note: Waste not included. Offset or wall mounted tapware required for standard (460mm) cabinets.

Corrida Inset



White Gloss Corrida Inset Mineral Composite Basin

Availability

WG COR-BS-430-WG-U \$385

Approx Capacity: 7.9L

Cut Out Size: 310mm

Waste Size: 40mm without overflow

Min. Top Width x Depth OTH 530w x 460d

Min. Top Width x Depth 1TH Behind 530w x 525d

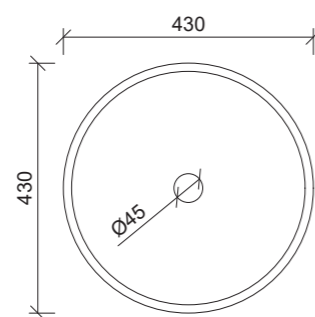

Taphole Offset

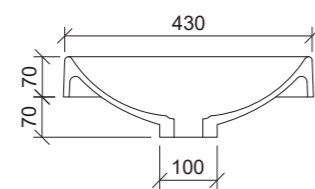
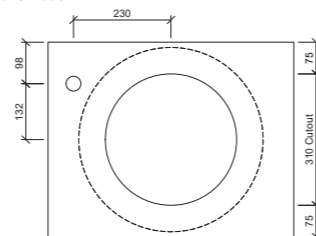

Inset

Drawings

Cut Out Specifications

Note: Waste not included. Offset or wall mounted tapware required for standard (460mm) cabinets.

Cove Grand Inset



White Gloss Cove Grand Inset Mineral Composite Basin

Availability

WG COV-BS-460-WG-U \$385

Approx Capacity: 9.8L

Cut Out Size: 421mm w x 301mm d

Waste Size: 40mm without overflow

Min. Top Width x Depth 560w x 460d

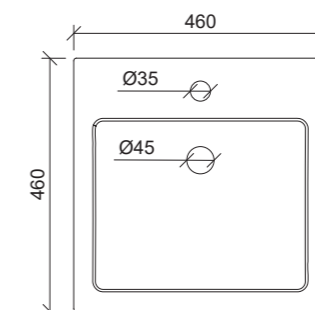

Taphole Behind

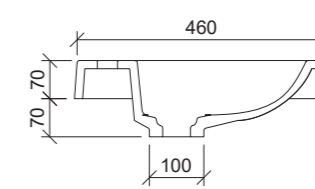
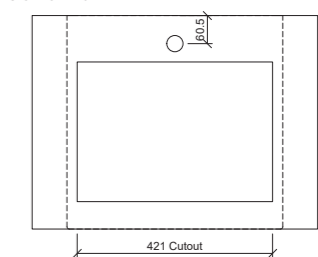

Inset

Drawings

Cut Out Specifications

Note: Waste not included. Comes with tap landing.

Fergus Semi-Recessed



Availability

WG FER-BS-500-WG-U \$385

Approx Capacity: 10L

Cut Out Size: 480mm w x 285mm d

Waste Size: 40mm without overflow

Min. Top Width x Depth OTH 600w x 335d

Min. Top Width x Depth 1TH Behind 600w x 390d



Semi-Recessed

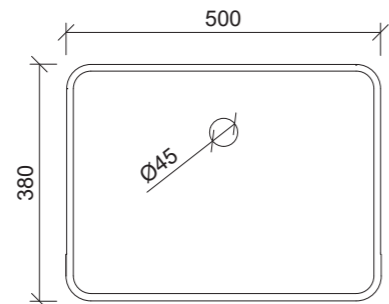

Drawings

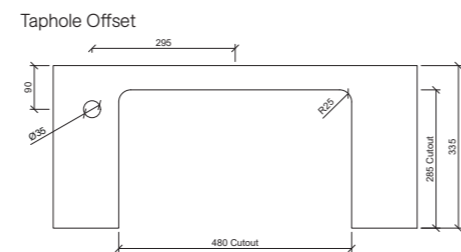
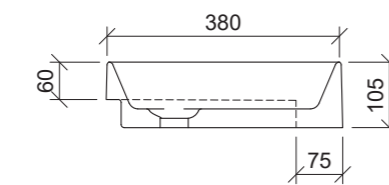

Cut Out Specifications

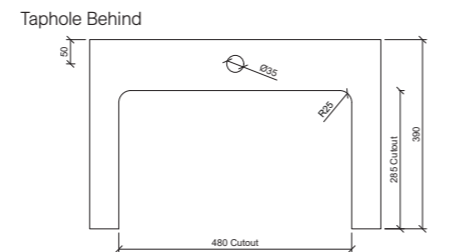

Note: Waste not included. Only suits a vanity with a fascia panel.

Amara Under Counter

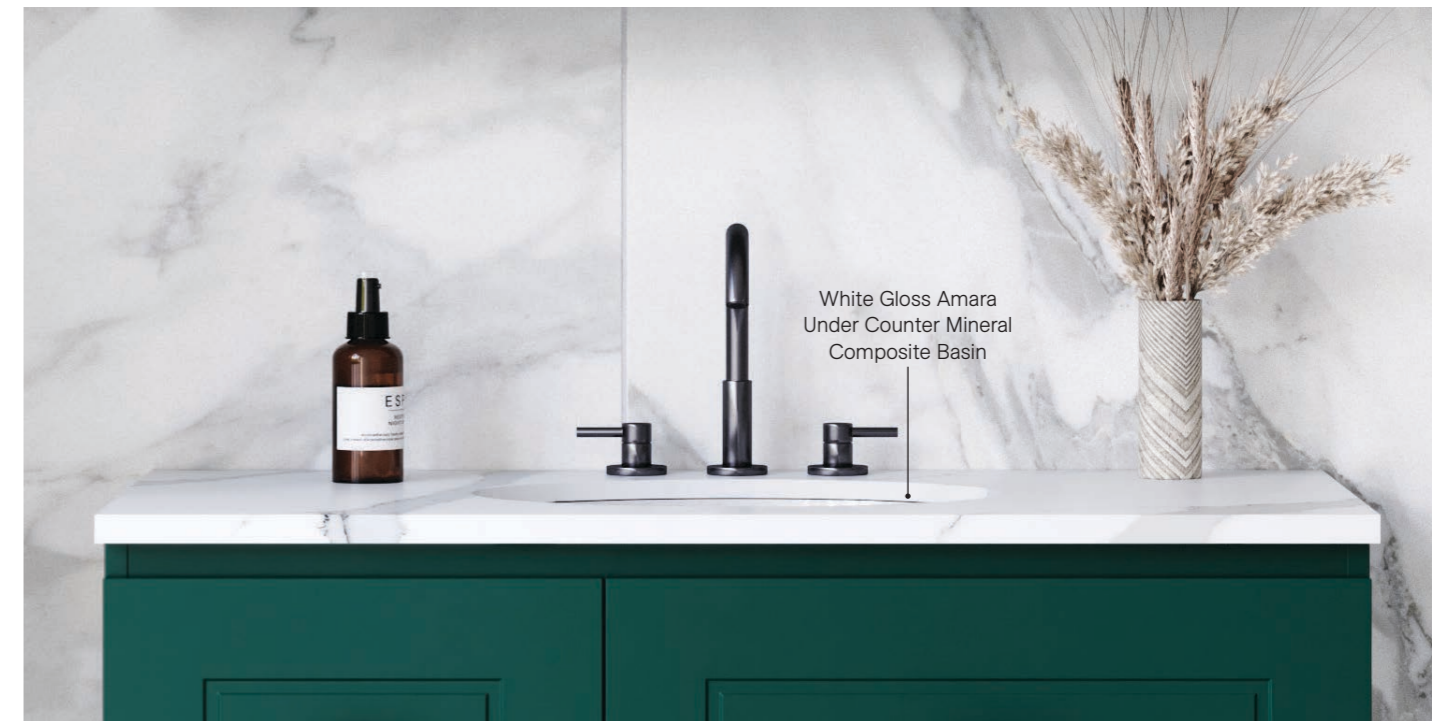

Availability

WG AMA-BS-450-WG-U \$385

Approx Capacity: 3L

Cut Out Size: 381mm w x 266mm d

Waste Size: 40mm with overflow

Min. Top Width x Depth OTH 520w x 440d

Min. Top Width x Depth 1TH Behind 520w x 460d

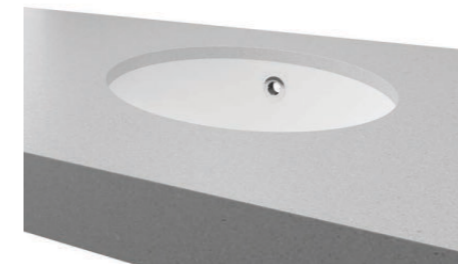

Under Counter

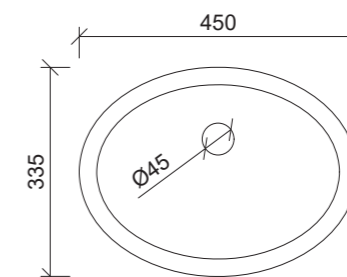

Drawings

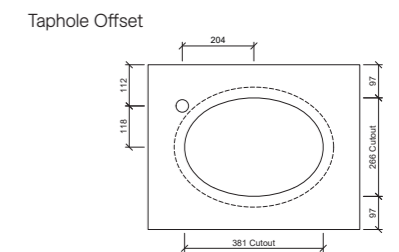
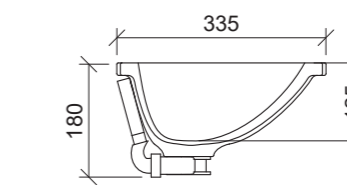

Cut Out Specifications

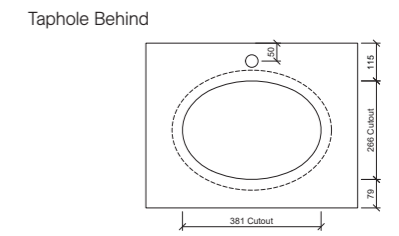

Note: Waste not included. Chrome overflow only.

Bodhi Under Counter



Availability

WG BOD-BS-540-WG-U \$385

Approx Capacity: 3.5L

Cut Out Size: 496mm w x 303mm d

Waste Size: 40mm with overflow

Min. Top Width x Depth OTH 640w x 430d

Min. Top Width x Depth 1TH Behind 640w x 460d



Under Counter

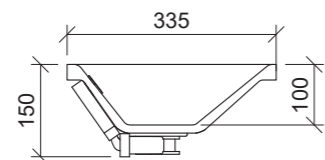
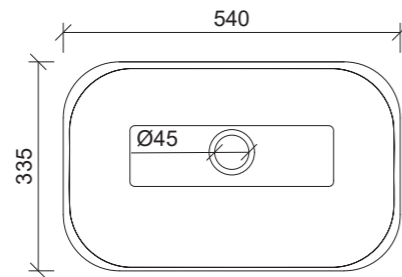

Drawings

Taphole Offset

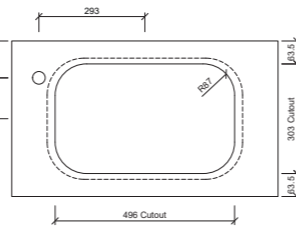

Taphole Behind

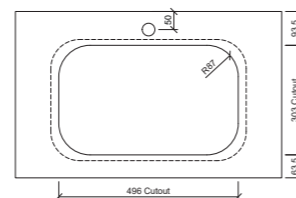

Cut Out Specifications

Note: Waste not included. Chrome overflow only.

Ruby Under Counter



Availability

WG RUB-BS-530-WG-U \$385

Approx Capacity: 3.5L

Cut Out Size: 487mm w x 195mm d

Waste Size: 40mm with overflow

Min. Top Width x Depth OTH 630w x 330d

Min. Top Width x Depth 1TH Behind 630w x 360d

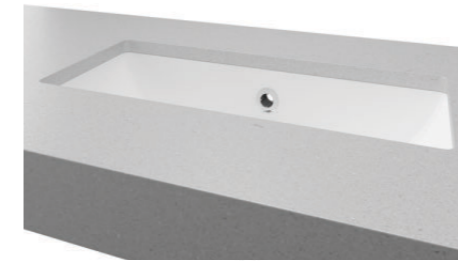

Under Counter

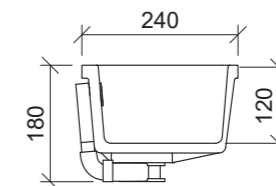
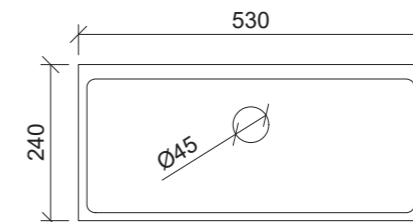

Drawings

Taphole Offset

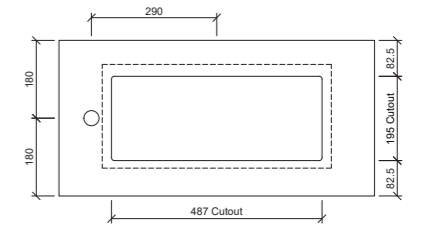

Taphole Behind

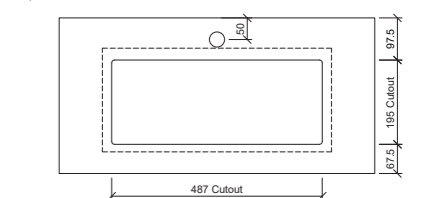

Cut Out Specifications

Note: Waste not included. Chrome overflow only.



Stainless Steel Collection

- ✓ Durable
- ✓ Easy to clean
- ✓ 1 year warranty

- ✗ No overflow
- ✗ Susceptible to scratches

Luxe



Availability

BG	LUX-BS-360-BG-U	\$665
BN	LUX-BS-360-BN-U	\$665

Approx Capacity: 11L
Cut Out Size: 80mm
Waste Size: 32mm without overflow

Min. Top Width x Depth OTH 380w x 360d
Min. Top Width x Depth 1TH Behind 380w x 460d

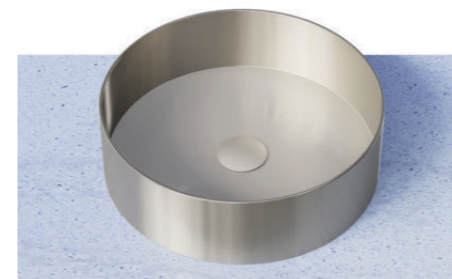

Above Counter

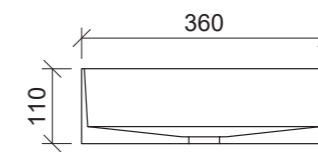
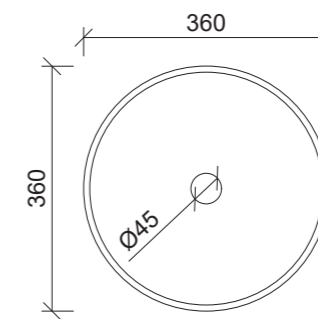

Drawings

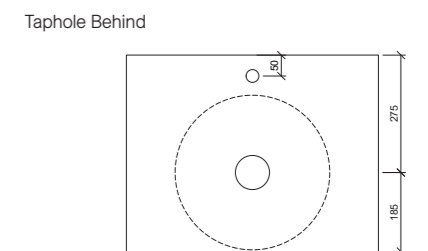
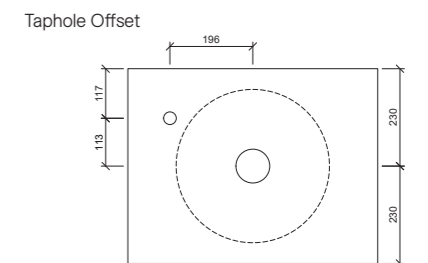

Cut Out Specifications

Note: Waste included.

